

RADIO — ELECTRONICS

K

SPECIAL
AUDIO-SOUND NUMBER

HUGO GERNSBACH,
Editor

formerly

**RADIO
CRAFT**

KSTC.



SONIC ANALYZER
SEE AUDIO SECTION

LATEST IN RADIO — ELECTRONICS — TELEVISION

OCT
1948

30

U. S. and
CANADA

520 Sq. In. PICTURE

TELEVISION
ASSEMBLY CO.

PROJECTION TELEVISION

IN ASSEMBLY FORM

COMPLETE WITH RACK

FULL NEWSPAPER PAGE SIZE!

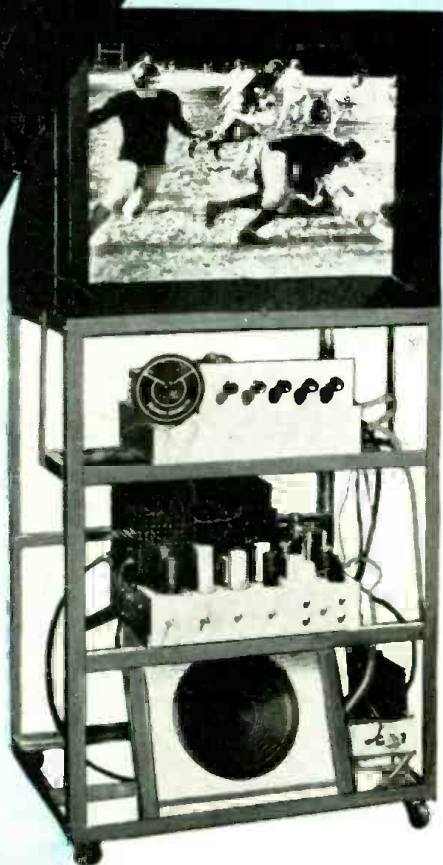

#OOD-SIMULATED METAL
ENCLOSURE FOR ABOVE KIT
AVAILABLE AT
SLIGHT EXTRA COST

**VISIT OUR TELEVISION DE-
PARTMENT. SEE AND HEAR
ASSEMBLED TELEVISION KITS
IN OPERATION.**

**FREE! Write today for our Big, New
TELEVISION Kits & Parts CATALOG!**

20"x26" PICTURE • 36 RCA TUBES • EASTMAN KODAK PRO-
JECTION SCREEN • f1.9 BAUSCH & LOMB PROJECTION LENS
• 30 KV FLY-BACK POWER SUPPLY • ANTENNA • PICTURE &
SOUND I.F. FACTORY WIRED & TUNED • DUMONT INPUTUNER

For realism, clarity, definition and
BIG SCREEN Televiewing, the pictures
produced by this unit have no equal!

This screen is absolutely flat, pre-
cluding curvature distortion anywhere
in the picture. Picture tones are true
black, grey and white—high in bril-
liance, yet absolutely glare-free!

Easy to assemble! Everything is sup-
plied, including prewired high voltage
power supply, Dumont Inputuner,
wired and pretuned 13 tube I.F. strip
for picture and sound, precision
Bausch and Lomb f1.9 projection
lens, Eastman Kodak projection screen,
mirror, 36 RCA tubes including 5TP4
projection tube, special dipole with
reflector and 60 ft. coaxial lead-in,
12" heavy duty RCA PM speaker,
push-pull 12 watts audio, rack and
picture frame as illustrated, all parts,
wire, hardware, etc. Big easy-to-
follow manual of instructions and sche-
matic data prepared and edited by
renowned John F. Rider, Publisher.

The list price of the P-520 kit is only
\$1299.00, with adequate margins for
Television Service-Dealers. Write us
today for special dealer price!

TERMINAL HAS BIGGEST STOCK OF
BEST BUYS IN TELEVISION KITS,
PARTS and ACCESSORIES!

TELEVISION ASSEMBLY KITS, com-
plete with all parts, tubes, etc. with
factory wired and tuned R.F. and I.F.
sections.

TA-10, 10" Model, net.....229.50
TA-12, 12" Model, net.....259.50
TA-15, 15" Model, net.....349.50
CHAMPION Models, same as above
but with famous Dumont Inputuner.
10" Champion, net.....273.10
12" Champion, net.....303.10
15" Champion, net.....393.10

DUMONT INPUTUNER—R.F. section
which tunes continuously from 44 to
216 Mc., complete with tubes and
dial58.65

Picture and Sound I.F. Strip—factory
wired and aligned. With 13 matched
RCA tubes, your cost77.25

SARKES-TARZIAN—New 13 channel
R.F. tuner, complete with tubes 31.75

RCA—popular 13 channel R.F. front
end, complete with tubes44.10

Bausch & Lomb Television Projection
Lens, f1.9, with mounting ring, for
use with 5TP4 tube. Net price 135.00

TERMINAL RADIO CORP.

85 CORTLANDT STREET • NEW YORK 7, N. Y.

Phone: WOrth 4-3311

Cable Address: TERMRADIO

LEARN RADIO

BY PRACTICING IN SPARE TIME

As part of my Course I send you the speaker, tubes, chassis, transformer, loop antenna, etc., to build this modern, powerful Radio Receiver! In addition, I send you parts to build many other real Radio circuits, like the Signal Generator, Radio Tester and Superheterodyne Receiver pictured below. You use this material to get practical Radio experience and to make EXTRA money fixing neighbors' Radios in spare time. Mail coupon below for complete information!

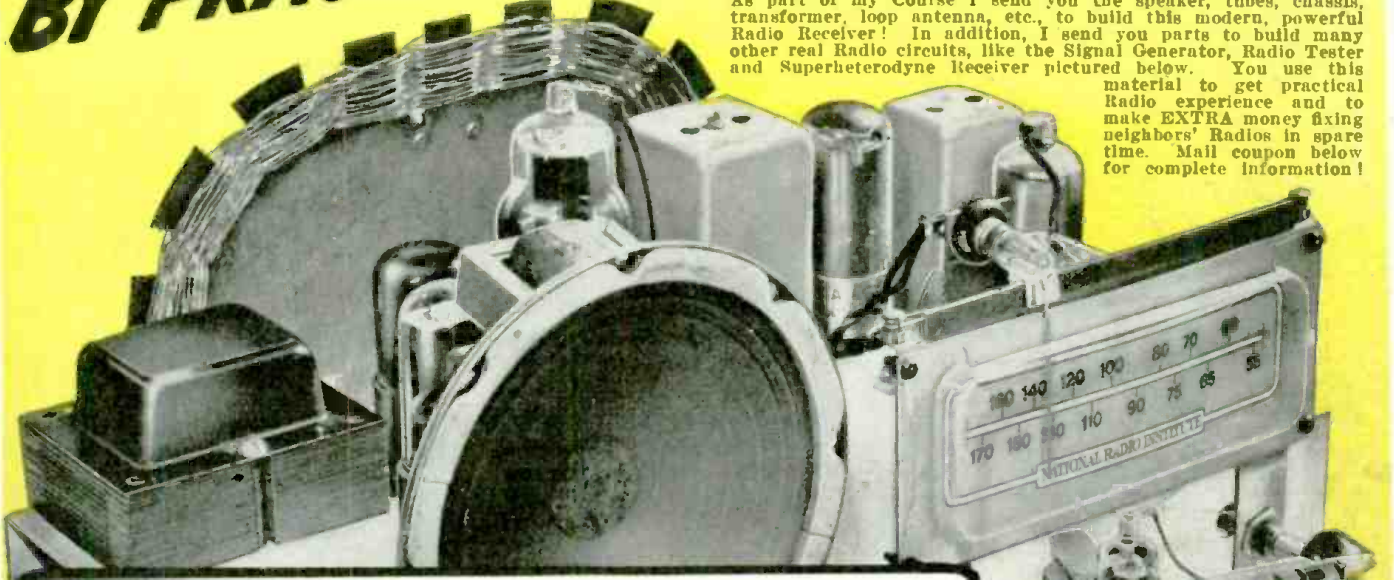

I SEND YOU BIG KITS OF PARTS

You Build and Experiment

With this MODERN RADIO

AND MANY OTHER CIRCUITS



J. E. SMITH, President
National Radio Institute

Do you want a good-pay job in the fast-growing Radio Industry—or your own money-making Radio Shop? My train-at-home method has helped hundreds of men with *no previous experience* become qualified Radio Technicians. Mail the Coupon and you'll get a Sample Lesson and my 64-page book, "How to Be a Success in RADIO-Television-Electronics," both FREE. See how you get practical Radio experience at home, building, testing Radio circuits with BIG KITS OF PARTS I send!

Future for Trained Men is Bright in Radio, Television, Electronics

It's probably easier to get started in Radio now than ever before, because the Radio Repair Business is booming. Trained Radio Technicians also find profitable opportunities in Police, Aviation, Marine Radio, Broadcasting, Radio Manufacturing, Public Address work. Think of even greater opportunities as public demand for Television, FM, Electronic devices continues to grow. Get the facts on all these opportunities. Send for FREE books now!

Find Out What NRI Can Do For You

Mail Coupon for Sample Lesson, "Getting Acquainted With Receiver Servicing," and my FREE 64-page book. It's packed with facts about Radio's opportunities for you. Send the details about my Course. Read letters from men I trained, telling what they are doing, earning. See how quickly, easily you can get started. No obligation. Just MAIL COUPON NOW in an envelope or waste # on a penny postal.

J. E. SMITH, Pres., Dept. 8KX
National Radio Institute, Pioneer Home
Study Radio School, Washington 9, D. C.

I TRAINED THESE MEN

Makes \$60 A Week Plus Bonus
"I am Radio Serviceman for The Adams Appliance Co. Am now getting \$60 a week, plus bonus and overtime."—W. A. ANGEL, Blythesville, Arkansas.

Knew Nothing About Radio
"I knew nothing about Radio when I enrolled. I am doing spare time work. I have more than paid for my Course and about \$200 worth of equipment."—RAYMOND HOLT CAMP, Vandalia, Illinois.

Many Beginners Soon Make EXTRA Money in Spare Time While Learning
The day you enroll I start sending EXTRA MONEY manuals. You learn Radio principles from my easy-to-understand, illustrated lessons—PRACTICE what you learn with parts I send—USE your knowledge to make EXTRA money fixing neighbors' Radios in spare time while still learning! From here it's a short step to your own full-time Radio Shop or a good Radio job!

VETERANS

You can get this training under G. I. Bill. Mail coupon.

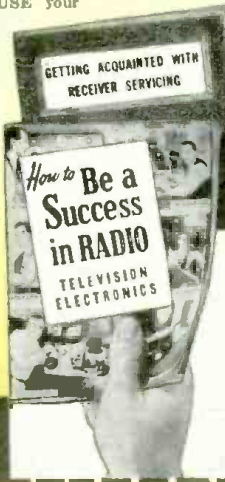

Good for Both—FREE

MR. J. E. SMITH, President, Dept. 8KX
National Radio Institute, Washington 9, D. C.

Mail me FREE Sample Lesson and 64-page book. (No salesman will call. Please write plainly.)

Age.....
Name.....
Address.....
City..... Zone..... State.....
 Check if Veteran

My Course Includes Training in TELEVISION • ELECTRONICS FREQUENCY MODULATION

RADIO — ELECTRONICS

formerly RADIO-CRAFT

Incorporating
SHORT WAVE CRAFT* TELEVISION NEWS*
RADIO & TELEVISION

*Trademark registered U. S. Patent Office

Special Audio-Sound Number

Hugo Gernsback, Editor-in-Chief
Fred Shuneman, Managing Editor
M. Harvey Gernsback, Consulting Editor
Robert F. Scott, W2PWG, Technical Editor
R. H. Dorf, W2QMI, Associate Editor
I. Queen, W2OUX, Editorial Associate
Angie Pascale, Production Manager
Elmer Fuller, Shortwave Editor
Wm. Lyon McLaughlin,
Tech. Illustration Director
G. Aliquo, Circulation Manager
John J. Lamson, Advertising Director
Alfred Stern, Promotion Manager

Contents — October 1948

Editorial (Page 21)	
Radio-Craft Becomes Radio-Electronics.....	by Hugo Gernsback 21
Audio (Pages 22-55)	
Ultra Loud Speaker Is Auto-Truck Size.....	by Paul H. Thomsen 22
Modern Microphones.....	25
Interesting Amplifiers.....	26
Modern Crystal Phono Pickups.....	29
Microgroove Phonograph Records.....	by M. Harvey Gernsback 30
Electronic Organ Improved with FM.....	by William K. Allan 32
New Trends in Loud Speakers.....	34
Four-Watt Portable for All-Around Use.....	by Lyman E. Greenlee 36
A Synthetic Bass Note Circuit.....	37
Packaging and Unitizing Audio Equipment.....	by Eric Leslie 38
A Sonic Analyzer (Cover Feature).....	40
Radio Set and Service Review (Amplifier Co. of America Model 810).....	42
Frequency Test Records.....	by Richard H. Dorf 46
Phase Inversion Headaches.....	by James R. Langham 50
Calibrating Audio Oscillators.....	by Richard D. Henry 52
New Magnetic Pickups.....	by I. Queen 55
Television (Pages 60-64)	
Cascade Preamp Reduces TV "Snow".....	by I. Queen 60
Television Sweep Circuits.....	by Allan Lytel 62
Electronics (Pages 68-72)	
The Crystal Detector, Part IV.....	by Jordan McQuay 68
Construction (Pages 75-77)	
Binaural Amplifier.....	by Edwin Bohr 75
Foreign News (Pages 78-80)	
European Report.....	by Major Ralph W. Hallows 78
Departments	
The Radio Month.....	10
Radio Business.....	16
New Devices.....	56
People.....	74
Question Box.....	81
Technotes.....	83
Radio-Electronic Circuits.....	84
Try This One.....	86
Miscellany.....	87
New Patents.....	88
World-Wide Station List.....	
by Elmer R. Fuller	90
Communications.....	93
Book Reviews.....	95

RADIO-ELECTRONICS, October, 1948, Volume XX, No. 1, Published monthly on the 25th of month preceding date of issue by Radercraft Publications, Inc., Erie Ave., F to G Streets, Philadelphia 32, Pa. Entered as second class matter at Post Office, Springfield, Mass., under Act of March 3, 1879. Application pending transfer to the Philadelphia, Pa., Post Office. SUBSCRIPTION RATES: In U. S. and Canada, in U. S. possessions, Mexico, South and Central American countries, \$3.50; \$6.00 for two years; \$8.00 for three years, single copies 30c. All other foreign countries \$4.50 a year, \$8.00 for two years, \$11.00 for three years. Allow one month for change of address. When ordering a change, please furnish an address stencil impression from a recent wrapper. RADERCRAFT PUBLICATIONS, INC. Hugo Gernsback, Pres.; M. Harvey Gernsback, Vice-Pres.; G. Aliquo, Sec'y. Contents Copyright, 1948, by Radercraft Publications, Inc. Text and illustrations must not be reproduced without permission of copyright owners. EDITORIAL and ADVERTISING OFFICES, 25 West Broadway, New York 7, N. Y. Tel. REctor 2-9690. BRANCH ADVERTISING OFFICES: Chicago: 308 W. Washington Street, Telephone Randolph 7363. Detroit: Frank Holstein, Room 402 Lexington Bldg., 2970 West Grand Blvd. Telephone Madison 7026-7. Los Angeles: Ralph W. Harker, 606 South Hill St., Tel. Tucker 1793. San Francisco: Ralph W. Harker, 382 Market St., Tel. Garfield 1-2381. FOREIGN AGENTS: Great Britain: Atlas Publishing and Distributing Co., Ltd., 18 Bride Lane, Fleet St., London E.C.4. Australia: McGill's Agency, 179 Elizabeth Street, Melbourne. France: Brentano's, 37 Avenue de l'Opera, Paris 2e. Holland: Teletron, Heemsteede, Dreef 124 Heemsteede. Greece: International Book & News Agency, 17 Amerikis Street, Athens. S. Africa: Central News Agency, Ltd., Cor. Risik & Commissioner Sts., Johannesburg; 112 Loux Street, Capetown; 369 Smith Street, Durban, Natal. Universal Book Agency, 70 Harrison Street, Johannesburg. Middle East: Steinmatzky Middle East Agency, Jaffa Road, Jerusalem. India: Sushil Gupta (Distributors) Co., Armita Bazar Patrika Lt., 11 Ananda Chatterjee lane, Calcutta.

Editorial and Executive Offices: 25 West Broadway, New York 7, N. Y.  MEMBER AUDIT BUREAU OF CIRCULATION ABC PAID CIRCULATION 6 MONTHS TO DEC. 31. 1947-102,688. (Publishers Statement) PRINTED FOR OCTOBER ISSUE - 150,000

First again



for radio men!

This year—the same as every year —Solar is first to give television service men the most needed developments in electrolytic capacitors.

Keeping pace with the fast-moving television industry, SOLAR'S new Type DY-TV series dry electrolytic capacitors assure dependable operation under the severest demands of modern television... permit high temperature operation with no sacrifice in long life or electrical characteristics. Investigate SOLAR and you'll buy SOLAR next time—every time! Write today for catalog.

SOLAR CAPACITOR SALES CORP. NORTH BERGEN, NEW JERSEY

 TELEVISION ELECTROLYTICS
RADIO-ELECTRONICS for



Learn RADIO

TELEVISION, ELECTRONICS

by

SHOP METHOD HOME TRAINING

Let NATIONAL SCHOOLS, of Los Angeles, a practical Technical Resident Trade School for almost 50 years, train you for today's unlimited opportunities in Radio

You receive all parts, including tubes, for building this fine, modern Superheterodyne Receiver. This and other valuable standard equipment becomes your property.

these two FREE books will tell you how



Good Jobs Await the Trained Radio Technician

You are needed in the great, modern Radio, Television and Electronics industry! Trained Radio technicians are in constant and growing demand at excellent pay—in Broadcasting, Communications, Television, Radar, Research Laboratories, Home Radio Service, etc. National Schools Master Shop Method Home Study course, with newly added lessons and equipment, can train you in your spare time, *right in your own home*, for these exciting opportunities. Our method has been proved by the remarkable success of National Schools-trained men all over the world.

You Learn by Building Equipment with Standard Radio Parts We Send You

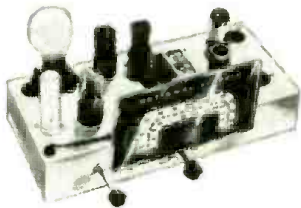

Your National Schools Course includes not only basic theory, but *practical* training as well—you learn by doing. We send you complete standard equipment of professional quality for building various experimental and test units. You advance step by step until you are able to build the modern superheterodyne receiver shown above, which is yours to keep and enjoy. You perform more than 100 experiments—build many types of circuits, signal generator, low power radio transmitter, audio oscillator, and other units. The Free Books shown above tell you more about it—send for them today!

Now! NEW PROFESSIONAL MULTITESTER INCLUDED!



This versatile testing instrument is portable and complete with test leads and batteries. Simple to operate, accurate and dependable. You will be able to quickly locate trouble and adjust the most delicate circuits. You can use the Multitester at home or on service calls. It is designed to measure AC and DC volts, current, resistance and decibels. You will be proud to own and use this valuable professional instrument.

Lessons and Instruction

Material Are Up-to-date, Practical, Interesting.

National Schools Master Shop Method Home Training gives you basic and advanced instruction in all phases of Radio, Television and Electronics. Each lesson is made easy to understand by numerous illustrations and diagrams. All instruction material has been developed and tested in our own shops and laboratories, under the supervision of our own engineers and instructors. A free sample lesson is yours upon request—use the coupon below.

You Get This and Other Valuable Information in the Free Sample Lesson:

1. Basic Receiver Circuits and How They are Used.
2. Construction of the Antenna Circuit.
3. How Energy is Picked Up by the Aerial.
4. How Signal Currents are Converted into Sound.
5. How the Tuning Condenser Operates.
6. How the R-F Transformer Handles the Signal, and other data, with diagrams and illustrations.

Both Home Study and Resident Training Offered

APPROVED FOR VETERANS

Check Coupon Below

NATIONAL SCHOOLS

LOS ANGELES 37, CALIFORNIA EST. 1905



MAIL OPPORTUNITY COUPON FOR QUICK ACTION

National Schools, Dept. RC-10, 4000 S. Figueroa, Los Angeles 37, Calif.

Paste on a postcard

Mail me FREE the books mentioned in your ad including a sample lesson of your course. I understand no salesman will call on me.

NAME AGE

ADDRESS

CITY ZONE STATE

Check here if Veteran of World War II

GET THE DETAILS—SEND THE COUPON

OCTOBER, 1948

CAPITOL RADIO ENGINEERING INSTITUTE

Pioneer in Radio Engineering Instruction—Since 1927



Who Will Get the Better Job?

The Serviceman Who Looks Ahead Will Get Ahead

Don't play blind man's bluff with your future! Are you, like many other professional servicemen, so wrapped up in your present routine work that you are losing sight of where you will be tomorrow?

Look at the successful serviceman. You'll find that he's the fellow who looked and *planned* ahead. Today, as a member of the great radio-electronic industry, you have opportunities that few men ever enjoyed in the past. Your future success can be assured by the plans *you* make *today*.

The radio industry is expanding so fast, that it is doubtful any serviceman can truthfully say he has kept pace with all the major developments. Thousands of new men have joined the ranks of the radio industry creating new competition for you. New developments create demands for more advanced technical ability. You can't afford to be

Send for and read our 24-page booklet that explains our self-improvement program—our courses—and what we can do for you and your future. CREI courses are still available at pre-inflation prices and today give you more thorough instruction service per dollar than ever before—on convenient terms. It costs you nothing to read the facts. Please write today.



Capitol Radio Engineering Institute

An Accredited Technical Institute

Dept. RC-10, 16th & Park Rd., N.W., Wash. 10, D.C.

Branch Offices: New York (7) 170 Broadway • San Francisco (2) 760 Market St.

a "pre-war model". You must "re-tool" your technical knowledge in order to keep pace.

If you are wise, you will look ahead and start now to increase your technical ability with the thorough, practical technical training for which thousands of professional servicemen have enrolled with CREI since 1927. This is real, honest-to-goodness practical engineering training that leads to better jobs presented by modern radio, electronics and television, and security in the knowledge that you are capable of coping with tough problems.

CREI courses are still available at pre-inflation prices and today give you *more thorough instruction service* per dollar than ever before—on convenient terms. It costs you nothing to read the interesting facts. Please write today.

VETERANS; CREI Training Is Available Under the "G.I." Bill!

MAIL COUPON FOR FREE BOOKLET

CAPITOL RADIO ENGINEERING INSTITUTE

16th and Park Road, N. W., Dept. RC-10, Washington 10, D. C.

Gentlemen: Please send your free booklet, "CREI training for your better job in Radio-Electronics," together with full details of your home-study training. I am attaching a brief resume of my experience, education and present position.

Check field of greatest interest:

- PRACTICAL RADIO-ELECTRONICS PRACTICAL TELEVISION
 BROADCASTING AERONAUTICAL RADIO ENGINEERING
 RECEIVER SERVICING INDUSTRIAL ELECTRONICS

NAME _____

STREET _____

CITY _____

ZONE _____ STATE _____

I AM ENTITLED TO TRAINING UNDER G. I. BILL.

RADIO-ELECTRONICS for

HERE'S THE
*Complete
Sprayberry
Course!*

LEARN RADIO

*ELECTRONICS-
TELEVISION!*



*I SEND YOU
8 BIG KITS OF
RADIO
PARTS!*

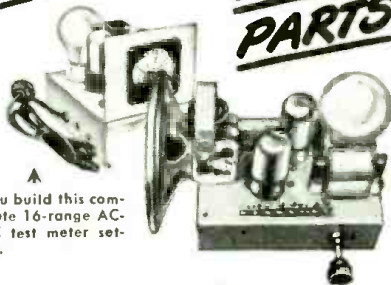

▲ You build this complete 16-range AC-DC test meter set-up.

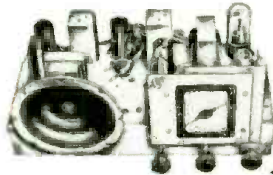

▲ I show you how to build this speaker tester and many other instruments.

▲ You build, test and trouble-shoot this powerful 6-tube superhet Radio.

I'LL TRAIN YOU AT HOME—BETTER—FASTER by Putting You to Work with Your Hands

In this picture I show you exactly what you'll get from me during your Sprayberry Radio Training. This actual photograph speaks for itself! Sprayberry Radio Training is *really COMPLETE*—I start you with interesting, easily understood basic knowledge and I keep the mailman busy bringing you valuable Service Manuals, profitable Business Builders, extra helps and books—and *8 Big Kits of Actual Radio Equipment!* My course is practical and down-to-earth. You get my personal help every step of the way. My method is *BEST* for you—because you train largely by working with your hands—building, testing, trouble-shooting with parts I supply. With these kits you build a powerful 6-tube superhet Radio, a big 16-range test meter and perform over 175 other fascinating practical experiments.

EARN WHILE LEARNING

Shortly after you enroll I send you my famous **BUSINESS BUILDERS** that help you get and do profitable neighborhood Radio Service jobs while learning. These jobs pay well, and pave the way for a Radio Service Business of your own.

All branches of Radio, Television and Electronics are booming! Trained men are needed **NOW!** I'll prepare you for your own profitable Radio Service Business or a big pay radio job in double quick time. You learn at home in spare time—you keep your present job while getting set for the future.

My course is so perfectly planned—so easy to grasp and understand—you need no previous knowledge or experience of Radio or Electricity. Get the facts now—find out what Sprayberry Radio Training can do for you. Mail the coupon below and by return mail I'll rush my big book, "How To

Make Money In Radio, Electronics and Television" that tells all about Sprayberry Training. I'll also send you a Sample Lesson, "How To Read Radio Diagrams and Symbols"—all **FREE**. You'll read many letters from successful Radio men I've trained—and you can decide for yourself what Sprayberry Training holds in store for you.

LOW COST COMPLETE TRAINING

Sprayberry Training is surprisingly Low In Cost—and if you desire, convenient monthly payments can be arranged. This is **COMPLETE**. Up-to-Date training—covering Radio Repairing, Television and F.M., Industrial Electronics and many other new developments. Sprayberry Trained men really know Radio. This is training that sticks with you and makes money for you.

FREE SAMPLE LESSON AND BIG CATALOG

See how quickly and easily you can get your start in Radio, Electronics, Television with Sprayberry Training. Just fill out, clip and mail the coupon **NOW** for my big **FREE** book and **FREE** Sample Lesson. No obligation. No salesman will call. Read all the facts about Sprayberry Training—then decide. Take the first step **TODAY**—rush the coupon to me.

VETERANS: Approved for G. I. Training under Public Laws 16 and 346. Check coupon and mail today for complete facts.

SPRAYBERRY ACADEMY OF RADIO

Frank L. Sprayberry, President

ROOM 20108, SPRAYBERRY BUILDING, PUEBLO, COLORADO



Mail COUPON Today!

FRANK L. SPRAYBERRY, President
SPRAYBERRY ACADEMY OF RADIO,
20108 Sprayberry Building, Pueblo, Colorado

Rush my **FREE** copies of "How To Make Money In Radio, Electronics and Television" and "How To Read Radio Diagrams and Symbols."

NAME.....

ADDRESS..... AGE.....

CITY..... ZONE..... STATE.....

Check here if a Veteran

**ALLIED'S NEW FREE
1949 RADIO CATALOG**

180 VALUE-PACKED PAGES

Send for it now!



The Preferred Radio Buying Guide

It's ready for you—the new 1949 ALLIED Radio Catalog! Get the Radio Buying Guide that's the first choice of thousands of expert service technicians, engineers, soundmen, Amateurs, builders and experimenters. The new ALLIED Catalog—Radio's largest and most complete—brings you 180 pages packed with the widest selections of the newest and finest equipment, at today's lowest, money-saving prices! Here's everything in radio for everyone in radio: new Television and home receivers; radio-phonos with new Dual-Speed Changers; packaged Sound Systems, high-fidelity sound components and P. A. equipment; latest Amateur receivers and station gear; test instruments; builders' kits; thousands of parts, tubes, tools, books—the world's largest and finest stocks of nationally known equipment. Take advantage of ALLIED's speedy, expert shipment and the personal attention of seasoned old-time radio men. Get the details, too, of radio's most liberal Time Payment Plan. Write today for your FREE copy of ALLIED's newest and greatest Catalog—the preferred Radio Buying Guide!

LARGEST STOCKS • QUICK, EXPERT SERVICE

**Send for your FREE copy of
Radio's Most Complete Catalog.
Use the coupon below — NOW!**

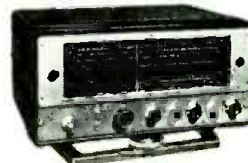
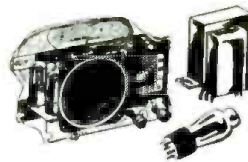

WORLD'S LARGEST STOCKS

Everything in radio for everyone in radio! ALLIED's huge stocks are the world's largest, including complete lines of all leading makes of parts and equipment. Get everything you need from one dependable centralized source—ALLIED RADIO!

TELEVISION & HOME RADIOS

See ALLIED'S outstanding selection of new Television sets, new table model radios, FM-AM combinations with new Dual-Speed Automatic Changers. Save on these radio models—the choice of experts!

AMATEUR STATION GEAR

You'll find everything you need for your shack in the new ALLIED Catalog. See all the latest releases in receivers, transmitters, parts, station equipment—the biggest and most complete listings in Ham radial!

NEW SOUND EQUIPMENT

Packaged, ready-to-use Sound Systems; amplifiers guaranteed for one full year; high-fidelity sound components; everything in speakers, mikes, P. A. accessories, intercom and recording equipment—headquarters for Soundmen!

**Radio's Leading
Buying Guide . . .**



**THE WORLD'S
LARGEST
RADIO
SUPPLY
HOUSE . . .**



ALLIED RADIO CORP.
833 W. Jackson Blvd., Dept. 2-K 8
Chicago 7, Illinois

Send FREE New 1949 ALLIED Catalog.

Name.....

Address.....

City.....Zone.....State.....



New I. C. S. Course Simplifies Radio Training

THE BEGINNER IN RADIO no longer has to stumble over technical explanations — or sidestep involved theories — in acquiring the training he needs to become a successful repairman.

These are carefully worked out for him in clear, simple language in a new home-study course developed by International Correspondence Schools.

But the student doesn't stop here. He puts principles and theory to work — using professional

quality tools and radio equipment supplied with the course. During his studies he assembles, wires and tests a modern 6-tube, 2-band receiver.

Long before his last lesson, the average student is in a position to start making his training pay. And by the time he completes the course, he is well equipped — in knowledge, tools and radio parts — for a good job in radio or a profitable service business of his own.



**INTERNATIONAL
CORRESPONDENCE SCHOOLS**
Box 2881-G, Scranton 9, Pa.

Without cost or obligation please send me full information on the courses before which I have marked X.

- | | |
|---|--|
| <input type="checkbox"/> RADIO SERVICING (with training equipment) | |
| <input type="checkbox"/> Radio, General | <input type="checkbox"/> Electrical Engineering |
| <input type="checkbox"/> Radio, Operating | <input type="checkbox"/> Lighting Technician |
| <input type="checkbox"/> Electronics | <input type="checkbox"/> Practical Electrician |
| <input type="checkbox"/> Practical Telephony | <input type="checkbox"/> Business Administration |
| <input type="checkbox"/> Telegraph Engineering | <input type="checkbox"/> Salesmanship |

Those who want to make good in Radio — who want a course that is complete, up-to-date, extremely practical — would do well to mail this coupon. Do it now!

Name _____

Address _____

City _____ State _____

Age _____ Occupation _____ Working Hours _____ A.M. to _____ P.M.

Employed by _____

Special tuition rates to members of the Armed Forces. Enrollment under G.I. Bill and P.L. 16 approved for World War II Veterans.

...Help end
spark plug
INTERFERENCE



Spark Plugs are miniature broadcasting stations, send signals that interfere with radio reception, distort television. The New Auto-Lite "Resistor" Spark Plug reduces this interference.*



Recommend **NEW**
AUTO-LITE
Resistor
SPARK PLUG

Here's How It
Works to End
Interference

The "Resistor" acts to dampen the spark plug radio signal to an acceptable level* while still delivering the full high voltage discharge required to ignite the fuel.

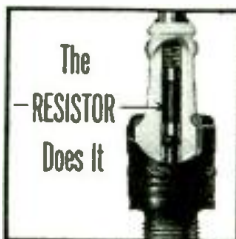

Auto-Lite Ignition Engineers, working with leading automotive manufacturers, have developed the new Auto-Lite "Resistor" Spark Plug with this built-in resistor that reduces spark plug interference.* Remember, the "Resistor" also helps deliver smoother idling, improved economy, longer electrode life. Dealers are being supplied as rapidly as possible. Write for Booklet M-1186 for full information.

THE ELECTRIC AUTO-LITE COMPANY
Toronto, Ontario Toledo 1, Ohio

*Under 35mv/m from 540 k.c. to 150 m.c. at 50 ft.

Tune In "Suspense," Thursdays, 9:00 P. M., E. T., CBS

NEW TV STUDIOS will be constructed by the American Broadcasting Company in New York, Robert E. Kintner, ABC vice-president announced last month. The building to house the studios, billed as the largest in the country, will provide 2 million cubic feet of usable space. The principal studio will be 200 feet long and 100 feet wide, with a 45-foot ceiling. Soundproof translucent panels will divide the studio into smaller ones hut, when not in use, will be dropped by motor controls into slots built below the floor.

A NEW MAGNETRON which induces so much heat that laboratory workers become feverish and nearby eggs and pencils explode was announced last month by General Electric. The new tube operates at 1,000 mc. Its 50-kw output is said to be the greatest amount of power ever produced at this ultra-high frequency. Water cooling is used. According to G-E scientist Dr. R. B. Nelson, experiments are still being carried on to determine how much power can be developed at 1,000 mc.

STRATOVISION service will be inaugurated on a regular basis in Pittsburgh if an application made last month for a channel is granted by the FCC. Westinghouse Radio Stations, Inc., filed a request for Channel 8 to be used by an airplane to broadcast TV signals over a 250-mile-radius about Pittsburgh.

Successful Stratovision demonstrations (reported in RADIO-CRAFT recently) show that major technical problems have been solved. The new service would be the first link in a nationwide chain of airborne TV stations.

THE CANADIAN TAX of 25% on radios and electrical products was removed last month. The excise levy, according to manufacturers and dealers, reduced sales to a very low figure. The only tax now remaining on radios in Canada is the 10% sales tax.

RADIOTECHNICIANS hold the first "Town Meeting" of the 1948-49 season in New York City on September 27, 28 and 29, Harry Ehle, chairman of the Town Meetings Committee, announced last month.

The meeting will follow the general lines of the first Town Meeting of Radio Technicians held in Philadelphia last January. Several modifications have been worked out as a result of experience gained at that meeting.

The program will bring the technicians who attend the meeting up-to-the-minute instructions and data on television servicing, as well as information designed to make their lives easier as independent businessmen.

The New York gathering will be followed by a Town Meeting at the Hotel Bradford in Boston, November 15, 16 and 17, and by others in Atlanta in January, Los Angeles in March and Chicago in April if present plans are carried out.

TRANSISTORS may cause important changes in Army communications equipment, predicted Major General S. B. Atkin, Chief Signal Officer. The transistor (see last month's issue) will do most of the things a vacuum tube will do but requires no filament battery. This could eliminate 25% of the weight of portable army equipment. Army tests are being carried out to determine where the transistors could be used, and how far they will prove practical.

TELEVISION may be used by the Department of Agriculture to bring viewers news and information of agricultural products, the Department announced last month. The medium is the subject of a study under provisions of the Research and Marketing act. The project will be conducted by the Agriculture Department's radio service in cooperation with TV stations and networks.

NO TV NETWORK will conduct operations from coast to coast for at least 5 years, predicted Sidney Strotz, NBC vice-president, last month. He explained that transmission costs will be prohibitive for at least that length of time. He predicted, too, that television station operation would continue to be a losing proposition, financially, for another two years, but after that time would be a profitable operation for all concerned.

AN ELECTRONIC DETECTOR so sensitive that it can find metal impurities weighing less than one ten-billionth of an ounce was disclosed last month by Westinghouse Research Laboratories. The device can do a job in 5 to 15 minutes that would take several days with regular chemical methods.

William M. Hickman, physicist who developed the device, says it is a new application of the mass spectrometer, widely used in separation of atomic materials, detection of leaks in vacuum systems, and analysis of materials in synthetic rubber production.

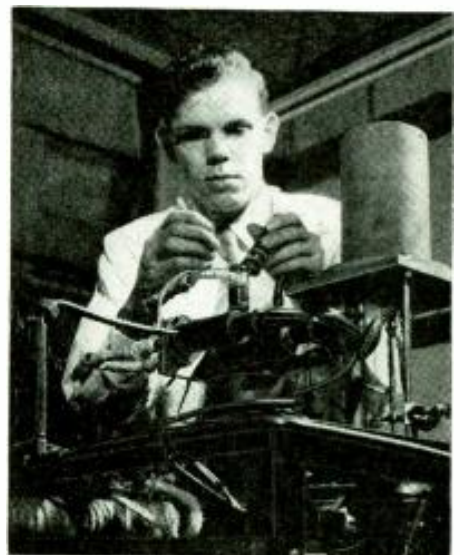

Loading sample chamber of mass spectrometer in preparation for an analysis of metal vapor.

RADIO-ELECTRONICS for

RATS WIRED FOR RADIO are being used to measure the effects of electrical brain stimulation, Dr. Joseph A. Gengerelli of UCLA announced last month. A small radio receiver, consisting of a miniature crystal rectifier and wire electrodes, are placed within the rat's head by an ingenious operation. High-frequency pulses generated in the laboratory are received, rectified and transmitted by an electrode to the proper part of the brain. The new method gives the rat freedom of movement for observation in contrast to an older method of direct wiring.

TELEPHONE RECORDING was authorized last month in Pennsylvania by the State Public Utility Commission. Subscribers will be provided by the telephone company with a connector to which they may attach their automatic voice recorders. According to the Utility Commission's ruling, an "automatic recorder connector tone signal" must be furnished with the connector. This device emits a brief tone signal every 15 seconds to indicate that recording is in progress. Without such a warning, recording is illegal on public communication lines. All customers will be required to release the telephone company from responsibility for any libel or slander.

ROCKET TRANSMITTERS capable of sending scientific information from a rocket 72 miles above the earth were operated successfully last month at White Sands Proving Grounds, according to *Science Service*. The rocket was travelling at a speed of more than 2,800 miles per hour.

The telemetering device used the Aerobee system to transmit 24 different kinds of continuous information to ground-based recorders. The system was evolved during the war by scientists of Princeton and Johns Hopkins Universities.

ELECTRONIC MUSIC is due for greater development and more artistic use, according to a statement made last month by Edgar Varese, distinguished composer. So far, says Mr. Varese, electronic instruments have been made to play the role of "freak ersatz", trying to imitate the sounds of conventional instruments. But ordinary instruments were perfected many years ago and it is time that these tools of music were changed and improved in step with other things in our modern world.

Mr. Varese reports that electronic instruments have been officially adopted in French schools. He has used them himself in compositions, not to imitate violins and flutes, but as completely new and different sounds, with music written especially for them.

The composer predicts that the development of electronic music will do away with the interpreter—the musician—whom he calls a "deforming prism between the composer and the listener." The hearer will press a button and the electronic instrument will reproduce the music exactly as the composer conceived it.

TECHNICAL ADVICE will be given to government agencies and other groups by the Joint Technical Advisory Committee, formation of which was announced last month. The Committee, which operates under the joint direction of the IRE and the RMA, will report to Dr. E. B. Shackelford, IRE president, and Dr. W. R. G. Baker, RMA director of engineering. Members were appointed on the basis of professional standing irrespective of their commercial affiliations. The first chairman is Philip F. Siling of RCA, representing the IRE. Vice-chairman is Donald G. Fink, Editor of *Electronics*, representing the RMA.

One of the committee's first jobs was the gathering of material on equipment availability and propagation characteristics for the u.h.f. spectrum, in preparation for the September FCC hearings on TV allocations.

TAXICAB TELEVISION was inaugurated last month by Charles de Lorne, a Chicago hack driver. Passengers say reception is fairly good with very little interference from other vehicles or buildings, though the picture is a little shaky over the bumps.

The set was installed by Motorola, Inc., as a promotion stunt. The company doesn't expect many cabbies to buy sets (too expensive) but it hopes the public will say: if television works so well in a moving car, think how much better it will show up at home!

FOOD STERILIZATION by means of a 2-million-volt X-ray generator was described last month in the *Journal of Applied Physics*. The generator is capable of producing either X-rays or cathode rays.

Acting as a source of electrons, rather than as an X-ray machine, the generator is believed capable of subjecting five tons of food to the equivalent of a million units of X-ray energy during a 24-hour day. Electrons were found to be much more effective than X-rays in sterilizing food. Bacteria can be completely killed with an ionizing dose that raises the food's temperature only 2 degrees.

VOICE OF AMERICA broadcasts will reach more European listeners because of additional relays inaugurated last month by the BBC. The new service involves the use of five additional BBC transmitters to increase BBC relays of the American broadcasts from three to nine hours daily. As with the old 3-hour schedule, relays will include long-, medium-, and short-wave transmissions. The new service is in addition to the 8-hour daily relay by the State Department's own transmitters in Munich.

RADIO AND TV COURSES will be offered this season by Columbia University and NBC, according to a network announcement last month. Twenty-seven courses will be included and 17 of the 21 instructors will be NBC staff members.

PLEASE TEAR OUT THIS ADV. AS REMINDER

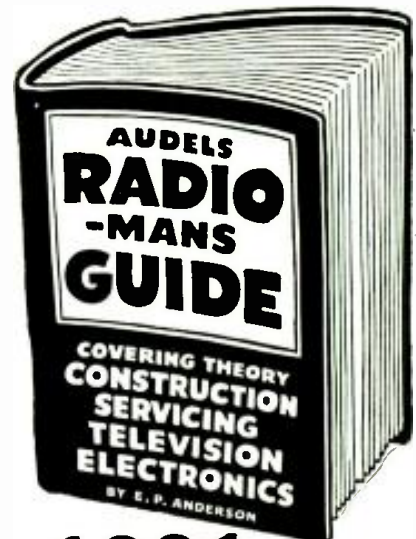

1001 RADIO FACTS AND FIGURES

AUDELS RADIOMANS GUIDE—914 Pages, 633 Illustrations, Photos, Wiring Diagrams, 38 Big Chapters, covering Radio Theory, Construction, Servicing, Including Important Data on Developments in Television, Electronics and Frequency Modulation, Review, Questions and Answers, Calculations & Testing. Highly Endorsed—Indispensable for Ready Reference and Home Study.

\$4 COMPLETE • PAY ONLY \$1 A MONTH
Step up your own skill with the facts and figures of your trade. Audels Mechanics Guides contain Practical Inside Trade Information in a handy form. Fully Illustrated and Easy to Understand. Highly Endorsed. Check the book you want for 7 days' Free Examination.

Send No Money. Nothing to pay postman.

CUT HERE MAIL ORDER

AUDELS, Publishers, 49 W. 23 St., NEW YORK 10, N. Y.

Please send me postpaid for FREE EXAMINATION books marked (x) below. If I decide to keep them I agree to mail \$1 in 7 Days on each book ordered and further mail \$1 monthly on each book until I have paid price—otherwise, I will return them.

- RADIOMANS GUIDE, 914 Pages . . . \$4
- ELECTRICIANS EXAMINATIONS, 250 Pages . . . 1
- WIRING DIAGRAMS, 210 Pages . . . 1
- ELECTRIC MOTOR GUIDE, 1000 Pages . . . 4
- ELECTRICAL DICTIONARY, 9000 Terms . . . 2
- ELECTRICAL POWER CALCULATIONS, 425 Pgs. . . 2
- HANDY BOOK OF ELECTRICITY, 1440 Pages 4
- ELECTRONIC DEVICES, 216 Pages . . . 2
- ELECTRIC LIBRARY, 12 vol., 7000 Pgs., \$1.50 vol.
- OIL BURNER GUIDE, 384 Pages . . . 1
- REFRIGERATION & Air Conditioning, 1280 Pgs. 4
- POWER PLANT ENGINEERS Guide, 1500 Pages. 4
- PUMPS, Hydraulics & Air Compressors, 1658 Pgs. 4
- WELDERS GUIDE, 400 Pages . . . 1
- BLUE PRINT READING, 416 Pages . . . 2
- SHEET METAL WORKERS Handy Book, 388 Pgs. 1
- SHEET METAL PATTERN LAYOUTS, 1100 Pgs. 4
- AIRCRAFT WORKER, 240 Pages . . . 1
- MATHEMATICS & CALCULATIONS, 700 Pgs. . . 2
- MACHINISTS Handy Book, 1600 Pages . . . 4
- MECHANICAL Dictionary, 968 Pages . . . 4
- AUTOMOBILE GUIDE, 1700 Pages . . . 4
- DIESEL ENGINE MANUAL, 400 Pages . . . 2
- MARINE ENGINEERS Handy Book, 1280 Pages 4
- MECHANICAL DRAWING GUIDE, 160 Pages . . . 1
- MECHANICAL DRAWING & DESIGN, 480 Pgs. 2
- MILLWRIGHTS & Mechanics Guide, 1200 Pgs. 4
- CARPENTERS & Builders Guides (4 vols.) . . . 6
- PLUMBERS & Steamfitters Guides (4 vols.) . . . 6
- MASONS & Builders Guides (4 vols.) . . . 6
- MASTER PAINTER & DECORATOR, 320 Pgs. 2
- GARDENERS & GROWERS GUIDES (4 vols.) 6
- ENGINEERS and Mechanics Guides
- Nos. 1, 2, 3, 4, 5, 6, 7 and 8 complete . . . 12
- Answers on Practical ENGINEERING . . . 1
- ENGINEERS & FIREMANS EXAMINATIONS . . . 1

Name _____
 Address _____
 Occupation _____
 Employed by _____ R.C.F.

**LOW
FACTORY
PRICES!**

... on the Sensationally NEW 1949
MIDWEST RADIOS

**NEW
SERIES 16
SUPER DE LUXE
AM-FM
CHASSIS**

30 DAYS TRIAL

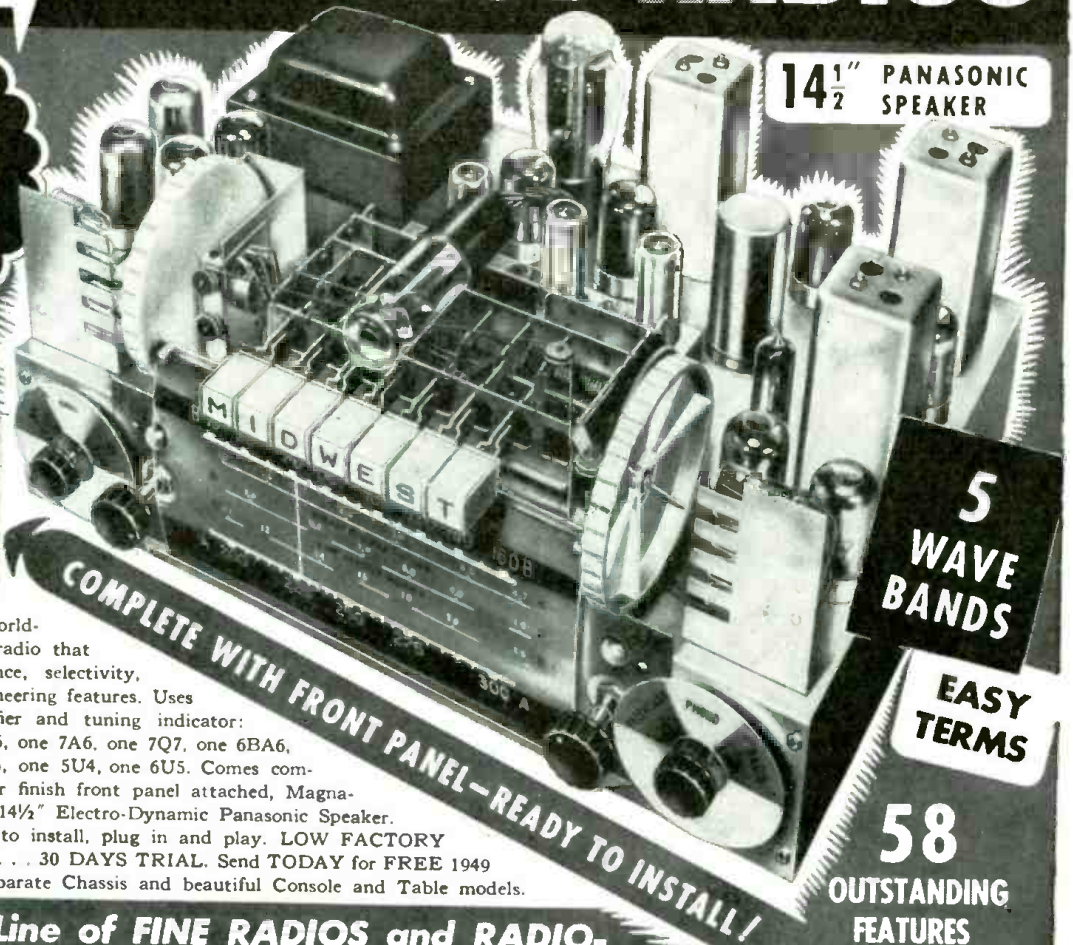

**14 1/2" PANASONIC
SPEAKER**

**5
WAVE
BANDS**

**EASY
TERMS**

58

**OUTSTANDING
FEATURES**

*Including the
Exclusive Midwest*

FLASH-O-MATIC
Volume and Band Indication

TELEVISION
Audio Switch-Over

FIDEL-A-STAT
Color-Ray Tone Selection

TRI-MAGNADYNE
Coil System

*...Plus NO-DRIFT FM
and many other features*

Here is the last word in radio engineering . . . a powerful, world-ranging, magnificently-toned radio that is unsurpassed for performance, selectivity, sensitivity, and advanced engineering features. Uses these latest-type tubes, rectifier and tuning indicator: three 7A7, three 7A4, two 7C5, one 7A6, one 7Q7, one 6BA6, one 6BE6, one 6C4, one 6AL5, one 5U4, one 6U5. Comes complete with satin stripe copper finish front panel attached, Magna-Tenna Loop Aerial and giant 14 1/2" Electro-Dynamic Panasonic Speaker. Requires only a few minutes to install, plug in and play. **LOW FACTORY PRICES . . . EASY TERMS . . . 30 DAYS TRIAL.** Send TODAY for FREE 1949 Midwest Radio Catalog of separate Chassis and beautiful Console and Table models.

**A Complete Line of FINE RADIOS and RADIO-
PHONOGRAPHS . . . Available in SEPARATE
CHASSIS Like the POWERFUL SERIES 16 AM-FM
Model above or in COMPLETE CONSOLES like this...**



Beautiful
SYMPHONY GRAND
AM-FM Radio-Phonograph with
TELEVISION Audio Switch-Over
and NEW Intermix AUTOMATIC
RECORD CHANGER

A Magnificent musical instrument and a masterpiece of cabinet design—the finest Midwest Radio in 29 years of manufacture. Offers world-ranging radio reception and newest automatic Intermix Record Changing Phonograph. Uses Series 16 Super DeLuxe AM-FM Chassis. Giant 14 1/2" Panasonic Speaker; Tri-Magnadyne Coil System; Built-In Loop Antenna. Other luxurious console and table model cabinets available with Series 16, 12, and 8 chassis—on Easy Terms and 30 Days Free Trial.

BUY DIRECT FROM FACTORY and SAVE!

MIDWEST RADIO & TELEVISION CORP.

Dept. 382 909 Broadway, CINCINNATI 2, OHIO

Rush for Free Catalog!

**FILL IN COUPON AND MAIL TODAY OR JUST
SEND NAME AND ADDRESS ON 1c POSTCARD**

MIDWEST RADIO & TELEVISION CORP.

Dept. 382 909 Broadway, Cincinnati 2, Ohio

Please send me your new FREE 1949 Catalog.

NAME _____
ADDRESS _____
CITY _____ ZONE _____ STATE _____

Here's Our **GREATEST** Combination of Training Advantages IN 17 YEARS to Help YOU...

Learn RADIO and TELEVISION

YOU KEEP ^{this} EQUIPMENT

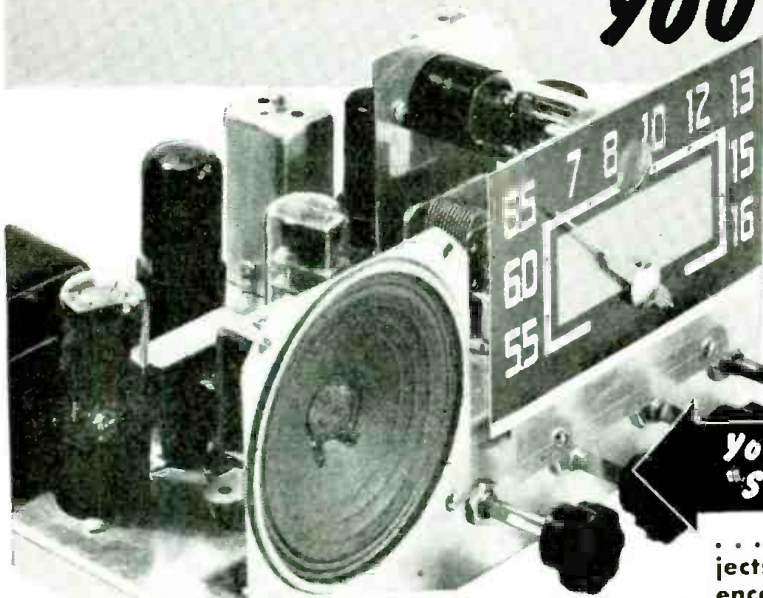

Here's good news . . . **BIG** news . . . our **BIGGEST NEWS** in 17 years. Now, **AT HOME**, you can get one of today's most effective combinations of Radio-Electronic training aids . . . and you **KEEP ALL EQUIPMENT**.

Mail coupon **TODAY!** Get **FREE FACTS** about D.T.I.'s amazing new home training. See how effectively D.T.I. prepares you to earn good money . . . do interesting work . . . enjoy a grand future in America's thrilling Radio-Television-Electronics fields.

You BUILD and KEEP this 6-tube "SUPER" RADIO RECEIVER . . .

. . . as one of your many "Learn-By-Doing" projects to help you get valuable "on-the-job" experience in **ASSEMBLY . . . WIRING . . . SOLDERING . . . ALIGNING . . . TESTING . . . and TROUBLE SHOOTING.**

A Jewel-Bearing, Self Powered **MULTI-METER**

You also receive the necessary parts from which you construct and keep this valuable, commercial-type test meter, which can help you earn while you learn.

Build Over 180

Experiments From These

RADIO PARTS

D.T.I. sends you many Radio-Electronic parts which you mount on bases with spring clip terminals for quick assembly . . . ideal for experimenting. Build and operate 8 different Radio Receiver Circuits . . . Radio Telephone . . . PA System . . . Electric Eye . . . and many other fascinating projects.



Effective EMPLOYMENT SERVICE helps you get started! Upon completing your training you can get the same effective employment service that has helped many D.T.I. graduates get started in the field.

DeFOREST'S TRAINING, Inc.

CHICAGO, ILLINOIS

Associated with the DeVry Corporation,
Builders of Electronic and Movie Equipment.

USE HOME MOVIES

. . . a D. T. I. Exclusive!

You also receive the loan of a 16 mm. Movie Projector and many reels of instructive, "Learn-By-Seeing" film to help you grasp basic points faster, easier. It's like a teacher in your home, giving you an **EXTRA** advantage many say is worth the cost of the entire training.

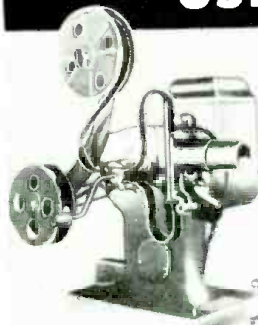

Modern CHICAGO LABORATORIES

If you prefer, you can get all your preparation in one of the nation's outstanding new training laboratories. If you come to Chicago, living quarters will be found for you.

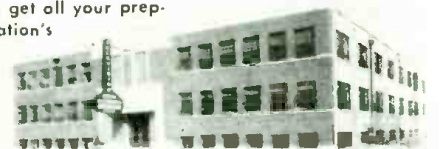

DeForest's Training, Inc.
2533 N. Ashland Ave., Dept. RC E10
Chicago 14, Illinois

MAIL TODAY

Send me complete details showing how I may make my start in Radio-Electronics-Television. No obligation.

Name Age

Address Apt.

City Zone State

If under 16, check here. If a discharged veteran of WWII, check here.

On RCA Top

**NEW
LOW
PRICES**



**RCA 15-watt
DE LUXE AMPLIFIER MI-12295**

• You've never seen a value like this distinctively styled RCA 15-watt All-Purpose Amplifier. You can't beat it for high quality performance, compactness, beauty, and simplicity of operation under all sorts of operating conditions.

Electronically engineered to give top performance. Frequency response (30 to 15,000 cycles). Two high impedance microphone input channels 116 db. gain (RMA), each with individual volume control. Two hi-impedance phono channels, one for hi-level and one for low-level pickups. Can be used with popu-

lar low output magnetic pickups. Phase inversion and inverse feedback used to obtain low distortion and uniform frequency response for various load conditions. Unique balanced tandem tone control circuit. Choke filtered power supply for minimum hum and uniform regulation. Large functionally designed control knobs. Accessible output terminal board and replaceable cartridge type fuse conveniently located in rear. Set of locking-type 3 pin Cannon plugs and receptacles for each microphone input. Also available with 2 low impedance inputs (250 ohms).

**NOW
ONLY
\$87⁵⁰**
List price complete with tubes

15 watt push-pull Output—
Noise-free electronic mixing—
Switch for high-low power
output requirements — Under-
writers-approved.

**Additional Unparalleled
Amplifier Values**

RCA 50-watt De Luxe Hi-Impedance Amplifier MI-12293 \$ **197⁵⁰**
Complete with RCA Tubes Now only

RCA 30-watt De Luxe Hi-Impedance Amplifier MI-12296 \$ **115⁰⁰**
Complete with RCA Tubes Now only



**SOUND PRODUCTS
RADIO CORPORATION of AMERICA**
ENGINEERING PRODUCTS DEPARTMENT, CAMDEN, N.J.

In Canada: RCA VICTOR Company Limited, Montreal

RADIO-ELECTRONICS for

Quality Sound Equipment

COMPARE...BE CONVINCED!

More business for you because it's RCA...

More profit because of these new values

RCA SPEAKER

MI-12422

12-inch high efficiency, Alnico V. Cone Type Mechanism. Special cone provides a selected listening characteristic—a result of thousands of listeners' reactions over the past 10 years. 10-watt capacity. 15 ohm voice coil.



\$12⁵⁰

Also available with matched 10-watt multi-tap line transformer as MI-12421.

\$18⁰⁰

RCA MOLDED SPEAKER BAFFLES

Molded Plasticized Fibre Baffle with attractive gray hammeroid finish and contrasting grille cloth, 12" x 15" x 5 1/2", sloping front, strong, moisture-resistant, and non-warping. Available for 5", 6 1/2" and 8" mechanisms as MI-6378, MI-6379, and MI-6380, respectively.



\$3⁷⁵

Similar baffles for 5", 6 1/2", 8", 10" and 12" mechanisms also available in molded Bakelite and wood.

All prices shown are suggested list prices subject to normal dealer discounts.

RCA VARACOUSTIC MICROPHONE

MI-6204-C

Three microphones in one. Here you have the popular cardioid microphone (uni-directional) *plus* standard velocity microphone (bi-directional) *plus* standard pressure microphone (non-directional) all in one general purpose unit. Variable characteristic obtained by ingenious slider mechanism on rear of housing. Quality and performance found heretofore only in more expensive polydirectional Broadcast Microphones. High sensitivity, shock mounted, high impedance. 30 feet of cable.

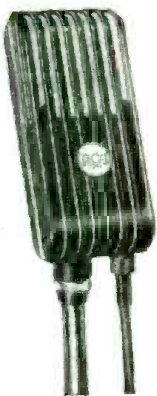

\$67⁵⁰

These and many other profitable items of sound equipment are available through your RCA Sound Products Distributor.

NEW BANTAM VELOCITY MICROPHONE

MI-12080-B

Smaller than a pack of cigarettes. First used at all 1948 political conventions. Broadcast quality. Built-in voice-music switch. 15 feet of cable.



\$60⁰⁰



BUY THE BEST FOR LESS

84 pages of sound products—microphones, amplifiers, speakers, recorders, intercoms, portable P.A. and numerous other profitable items. Send for your FREE copy today.

MAIL THIS COUPON FOR FREE CATALOG

RCA SOUND PRODUCTS (Dept. 111-J)
Radio Corporation of America
Camden, N. J.

Please send me free copy of RCA's new Catalog on complete line of matched sound products *and price list*.

Name _____

Company _____

Type of Business _____

Address _____

City _____ State _____

CLEARANCE SALE

STROMBERG CARLSON #29 Amplifier

In original cartons. Tops in tone quality Mike and phono input. Includes tubes 2—6SJ7, 1—5Y3, 1—5L6.

List \$57.75
Sale price **\$28.87**



TOM THUMB CAMERA RADIO



The perfect outdoor companion. Personal battery portable. Powerful 4-tube superhet. Built-in loop, hi-gain pickup. Full vision slide rule dial. Reflex-type camera. Uses standard 127 film. Compact unit 4 3/8" x 4 1/4" x 9 3/8".

List \$37.95
Sale price **\$22.97**

ELECTRO-VOX Intercommunication System



Complete with sub station. Use as a telephone. Convert from house to garage. From section of house to other. Ready for use, incl. 3 tubes. List \$34.95
Sale price **\$10.97**

Superior #770 Pocket Size Volt-Ohm Milliammeter



Sensitivity—
1000 ohms per volt
Automatic zero adjustment
6 A.C. VOLTAGE RANGES:
0-15/30/150/300/1500/3000 VOLTS
6 D.C. VOLTAGE RANGES:
0-7.5/15/75/150/750/1500 VOLTS
4 D.C. CURRENT RANGES:
0-1.5/15/150 MA 0-1.5 AMPS.
2 RESISTANCE RANGES:
0-500 OHMS 0-1 MEGOHM
Latest type D'Arsonval meter.

Streamlined plastic cabinet. Size—3 1/8" x 5 7/8" x 2 1/4". Complete with batteries, test leads, instructions and guaranty.
Net price only **\$13.90**

RADIO TUBES All new and guaranteed

688, Ken-Rad	\$.19	1T4, unbranded	\$.39
1626, RCA	.19	354, unbranded	.39
6C4, Natl. Union	.22	155, RCA	.44
6H6, RCA	.32	65H7, RCA	.44
35Z5, Std. brand	.34	12J5, RCA	.44
80, Std. brand	.36	14A7, Sylvania	.49
6J5, Sylvania	.36	14B6, Sylvania	.49
1LN5, Sylvania	.39	14Q7, Sylvania	.49
37, RCA	.39	35Y4, Sylvania	.49
25Z6, Std. brand	.39	50L6, Std. brand	.55

7500 VOLUME CONTROLS

10K, 25K, 50K, 1/4 meg, 1/2 meg, 1 meg, in the original factory packed cartons in bulk, known makes, Clarostat, Centralab, Stackpole, etc.

SALE PRICE without switch with switch
19c each 29c each

Mention size shaft desired and we will ship the actual size or the nearest to it.

GE, 12" PM SPEAKER, (aln. 5) 6.8 oz mag.	\$.95
12" SPEAKER BAFFLE, walnut cabinet	4.65
OUTPUT TRANSFORMER, matches 50L6 tube	.29
AC-DC CHOKE, 50 mils, 10 henrys	.29
100-ASST CONDENSERS, .001 to .02—600V	3.95
100-ASST SOCKETS, octal, loctal, min	3.95
100-ASSORTED RESISTORS, 1/2 watt	1.29

SALE PRICES EFFECTIVE THIS MONTH ONLY
Don't Delay, rush your order in now

BROOKS RADIO DIST. CORP.

80 VESEY ST., (Dept. A) NEW YORK 7, N. Y.

VIDEO CODE RELEASED

The Association of Better Business Bureaus recently released its "Recommended Standards for the Advertising and Selling of Television Receivers." Some of the high points follow:

A television set or receiver shall be understood as meaning one capable of receiving and reproducing televised pictures and accompanying sound. If a set or unit or attachment will reproduce television pictures only, without sound, such fact shall be conspicuously stated.

Advertising shall clearly and conspicuously indicate whether the price advertised for a television receiver includes the cost of installation, antenna, or other equipment, or service necessary for reception of television. If an installation charge is quoted in advertising, the charge quoted shall be the total charge required of the purchaser for assuring satisfactory reception on all channels within range, unless otherwise stated.

When a statement such as "No Money Down" is used in advertising, in reference to an installation payment plan, it shall mean that the purchaser will not be required to make any payment until after the merchandise has been delivered and installed, and no payment shall be required until the first due date specified in the sales contract.

Claims as to performance shall be limited to known facts, and to the practical performance of such receivers under normal operating conditions, and to those claims for which the advertiser would be willingly responsible to the individual purchaser.

When installation is performed by the seller, the responsibility of providing acceptable television reception rests with the seller, restricted only by qualifications in advertising and selling statements, or as defined in the service contract or guarantee by the seller or the manufacturer.

Whenever program material which is to be televised from motion picture film, as distinct from direct televising, is referred to in advertising, such fact shall be clearly and conspicuously disclosed.

If any reference is made to picture size of direct-view television receivers, the diameter of the television tube shall be stated. It is recommended that the size of the picture also be indicated by approximate area by square inches or dimensional measurements.

If the receiver is equipped with a built-in screen enlarger, that fact shall be conspicuously set forth. Any reference that is made to picture size of a receiver having a built-in enlarger shall also disclose the size of the picture tube.

RCA-SYLVANIA PATENTS

Arrangements have been completed recently by which Radio Corporation of America becomes a licensee under some two hundred radio and television tube patents of Sylvania Electric Products, Inc. The license runs for seven years at royalties of three-quarters of 1%, but not exceeding \$200,000 in any one year.

ADMIRAL SALES AT PEAK

In a mid-year statement to stockholders, the Admiral Corporation and subsidiaries of Chicago reported that sales and earnings for the first six months this year hit an all-time high. Sales were shown as \$27,386,344 as against \$21,548,786 last year, an increase of \$5,897,558. Excluding sales to the government, which in the first half of 1947 were \$3,409,355 as against no sales in the similar period this year, Admiral civilian sales more than doubled with an increase of 51%. Net earnings were \$1,237,297 as against \$854,456, an increase of \$328,841. Much of this gain was registered during the second quarter when earnings rose from \$342,995 in 1947 to \$706,887 this year, a jump of 106%. Acquisition by Admiral early in July of the electric-range manufacturing facilities of the Pressed Steel Car Company, Inc., strengthened the company's line of products.

G-E REPORTS GAINS

General Electric Company reported net income in the first six months of 1948 amounting to \$54,602,339, as compared with \$42,802,075 in the first half of 1947. Net sales billed set a new record in both the first half and in the second quarter. For the first half, sales totaled \$772,761,792, a rise of 29% over the \$601,342,810 billed for the same period a year ago. Second-quarter sales amounted to \$406,803,802, a 19% rise over the comparable 1947 quarter.

TV TUBE SALE INCREASE

Sales of radio and television equipment, including electron tubes, totaled \$40,351,820 during the first quarter of 1948, the Radio Manufacturers Association reported recently. Almost half of these sales, or \$18,053,969, went to the U. S. Government, and \$12,875,186 of the federal purchases were for radar equipment. Production of cathode-ray receiving tubes of the type used in TV sets showed the greatest gain over the corresponding period of 1947. First-quarter output this year of 170,430 was more than three times the production of the first quarter of 1947 when 51,214 such tubes were manufactured. Of the 1948 quarterly output, 158,706 went to set equipment manufacturers, 10,742 to users and distributors, 894 to the U.S. Government, and 88 to export.

CANADIAN SALES DOWN

Canada's radio set manufacturers have recently been facing the biggest production slowdown that they have ever experienced, but they saw one bright light on their horizon: the fact that two private broadcasters have applied for licenses for television transmitting stations in Toronto and Montreal. The Canadian Broadcasting Corporation plans to review the applications this October.

RADIO-ELECTRONICS for

Which Do You Want?



Better Pay



A Nice Home



A New Car



Greater Security



Happy Vacations and Travel

Jobs worth \$3000 to \$7500 are opening up right now for FCC Licensed Radiomen

How to Pass FCC Commercial Radio Operator LICENSE EXAMS



GET YOUR FCC TICKET IN A FEW SHORT WEEKS

Get your license easily and quickly and be ready for the \$3000 to \$7500 jobs that are open to ticket holders. CIRE training is the only planned course of coaching and training that leads directly to an FCC license.

IT'S EASY WITH CIRE COACHING AND TRAINING

Your FCC ticket is recognized in all radio fields as proof of your technical ability. Employers often give preference to license holders, even though a license is not required for the job. Hold an FCC "ticket" and the job is yours!

Look what these students say:

"Thanks to this course, I now have a very good job in a local power plant's test department. I couldn't have obtained this job without the math and basic electrical theories in the first part of Section 1 of this course." Stud. No. 2893N12

"I have been working for Police Radio Station WPFS in Asheville for five months since getting my second-class ticket." Stud. No. 2858N12

"You may be interested to know that I am employed at the local broadcast station, where I am a transmitter operator. I took and passed the FCC examinations last February." Stud. No. 2754N12

CLEVELAND INSTITUTE OF RADIO ELECTRONICS
 RC-10 Terminal Tower Cleveland 13, Ohio

Approved for Training under "G. I. Bill of Rights"



I can train you to pass your FCC License Exams in a few short weeks if you've had any practical radio experience—amateur, Army, Navy, radio servicing or other. My time-proven training plan can help put you, too, on the road to success—**Let me send you FREE the entire story** Just fill out the coupon and mail it. I will send you, free of charge, a copy of "How to Pass FCC License Exams," plus a sample FCC-type Exam and Catalog A, describing opportunities for you in Radio-Electronics.

EDW. H. GUILFORD, Vice-President.

Get All 3 FREE Send Coupon Now!

CLEVELAND INSTITUTE OF RADIO ELECTRONICS
 RC-10 Terminal Tower, Cleveland 13, Ohio

I want to know how I can get my FCC ticket in a few short weeks. Send me your FREE booklet, "How to Pass FCC License Examinations" (does not cover exams for Amateur License), as well as a sample FCC-type exam and Catalog A, describing opportunities in Radio-Electronics.

NAME

ADDRESS

CITYZONE.....STATE.....

Veterans check for enrollment information under G.I. Bill.

NO OBLIGATION—NO SALESMEN.

Voltage Regulator



Mfg. Raytheon; Navy CAD-301407; Pri: 92-138 v. 15 amps... \$99.50

VOLTAGE REG. "Transstat" American Type "RII" 2 Kva Load... \$40.00

TRANSFORMERS

(All Primaries - 115 V, 60 Cy.)

5055: 525 vet 75 ma. 5 v 2 amp. 6.3 v 1.3 amp. 10 v 2 amp... \$2.15

400 CYCLE TRANSFORMERS

HV PLATE XFMR: Pri: 115 v. 400 cy. Sec: 13.5 KV. 3.5 ma. GE #521652... \$14.50

INVERTERS

PE 206-A: Input: 28 VDC @ 38 amp. Output: 80 volts @ 500 volt-amps. 800 cycles. Leland, New. complete with enclosed relay, filter, instruction book... \$12.50

POWER CHOKES

Swing. Choke: 4.5 to 8 by: 2 to 1 amp. . . . \$10.95

EE-89A REPEATER

Extends range of field telephone apparatus, such as EE-8 up to 25 miles, when inserted in a line. New, with spare coils and instruction manual, less standard type batteries... \$21.50

BEAM MECHANISM

The most powerful, compact assembly ever offered on surplus for beam rotation, 60:1 gear ratio turned by 24 vdc motor that will run on 12 vdc. Bicycle type sprocket for easy coupling to any shaft. 9141-1011-WX-R11 with mounting facilities. New, guaranteed, complete with 115 vdc to 12 vdc step down transformer... \$16.50



DYNAMOTORS

Table with columns: Type, Input (Volts, Amps), Output (Volts, Amps), Ratio, Price*. Rows include models like BD 77KM, PE 73, DM 21, etc.

APS-15 "X" BAND: compl RF head and modulator, incl. 725-A magnetron & magnet, two 723-B klystrons... \$210.00

COAX CABLE

RG 18/U, 52 ohm imp, armored... \$.51/ft. RG 24/U, twin coax, 125 ohm imp, armored... \$.50/ft.

COAX CONNECTORS

831R... \$.35 UG 21/U... \$.85 831SP... \$.35 UG 86/U... \$.95 831AP... \$.35 UG 254/U... \$.75 831HP... \$.15 UG 255/U... \$.85

GREAT TUBE VALUES

Table of tube values with columns: Tube Type, Price. Rows include 01-A, 1A3, 1B24, 1M5, 1N5, 1T4, 2C21, etc.

THERMISTORS

Table of thermistors with columns: Part Number, Price. Rows include D-107322, D-170396, etc.

VARIABLES

Table of variable capacitors with columns: Part Number, Price. Rows include D-167176, D-170225, etc.

R.F. COILS

3C1016-7. RF coil Assy, 30-40 mc. for revr FMR-13V... \$.59

XMTR TUNING UNITS

BC 375: TU-9 (7.5-10mc); TU-10 (10-12.5 mc); TU-20 (350-650 kc); TU-26 (200-300 kc). Each... \$2.25

BC 1267 XMTR-RCVR

XMTR consists of tuned line pulse oscillator on 154-186 mc. Can be modified to operate on vices or CW, and built to work on the amateur 2-meter band. RCVR is a super-het with 2 stages of RF and 5 stagger-tuned I.F. stages... \$27.50

BAND PASS FILTER

#70473. Sharp band pass peaked at 700 cps (tunable). High-to-high impedance. Can be plugged into phone output of receiver. Cuts out QRM. New... \$2.25

HEADSETS

Dynamic mike and headset combination. A high quality, efficient unit, used in B-19 tank Xmtrs. Mike and phone complete, new... \$2.75

MICROPHONE ELEMENTS

Carbon transmitter element for TS11-J, TS11-L, TS13-E, TS15-A. Element for microphone T-21. 30 ohm resistance... \$.75 ea.

INSTRUCTION MANUALS

BC 312, BC 332... \$1.52 SCR 281... \$1.25 Mark II... \$.75 ZA Eqp1... .75 SCR 508... 1.00 BC 612... 1.00 SX-32... .75

VIBRATORS

TR 1216, 12 vdc, 5 pin... \$1.20 OAK V-6075, 21-32 vdc, 7 pin... \$1.10

HAND GENERATORS

GN 35: Output: 350 v, 60 ma, 8 v, 2.5 amp. less hand crank... \$3.50 GN 15: Output: 500 v, 100 ma, 6 v, 3 amp. less hand crank... \$5.50

CROSS POINTER INDICATOR: Two 0-200 microamp. movements in 3" case. Each movement brought out to 6-term. Interacts at rear. Originally used in ILS equip. \$2.50



131-C. Liberty St. New York 7, N.Y. All merchandise guaranteed. COMMUNICATIONS EQUIPMENT CO. PHONE DIGBY 9-4124 RADIO-ELECTRONICS for

Thousands Switch to PHOTOFACT for Quicker, Easier, More Profitable Servicing!

Thousands of Radio Service Technicians are *right!* They've found the way to quicker, easier, more profitable servicing. Join these thousands of successful money-making Servicemen who have switched to PHOTOFACT Service Data. Learn for yourself how this accurate, easy-to-use, practical data saves you time, makes your work easier, helps you earn more. PHOTOFACT gives you 100% useful service data—every photograph, every diagram, every bit of information helps you do a *complete job*. You owe it to yourself to switch to PHOTOFACT. There'll be a big difference in the time you save and the bigger profits you'll earn every single working day.



The Amazing Radio Industry **RED BOOK** Replacement Parts Buyer's Guide

NOW—stop wasteful hunting through dozens of incomplete parts manuals. The RED BOOK tells you what you need to know about replacement parts for approximately 17,000 sets made from 1938 to 1948. Includes complete, accurate listings of all 9 major replacement components—not just one. Lists correct replacement parts made by 17 leading manufacturers—not just one. Covers original parts numbers, proper replacement numbers and valuable installation notes on: Capacitors, Transformers, Controls, IF Coils (including Peak Frequencies), Speakers, Vibrators, Phono-Cartridges. *Plus*—Tube and Dial Light data for each receiver, and Battery replacement data. Get *all the right answers* in the RED BOOK. 440 pages, **\$3.95** 8½ x 11; sewed binding. **ONLY . . .**



Your Price
Each Volume,
In DeLuxe Binder **\$18.39**

PHOTOFACT VOLUMES The Preferred Service Data

Bring your file of post-war receiver Service Data right up to July, 1948! Here's the most accurate and complete radio data ever compiled—preferred and used daily by thousands of Radio Service Technicians. Includes: Exclusive Standard Notation Schematics; photo views keyed to parts lists and alignment data; complete parts listings and proper replacements; alignment, stage gain, circuit voltage and resistance analysis; coil resistances; record changer service data, etc. Order Volume 4 today—keep your Photofact library up-to-date—it's the *only* Radio Service Data that meets your *actual* needs!

- Vol. 4. Covers models from Jan. 1, 1948 to July 1, 1948
- Vol. 3. Covers models from July 1, 1947 to Jan. 1, 1948
- Vol. 2. Covers models from Jan. 1, 1947 to July 1, 1947
- Vol. 1. Covers all post-war models up to Jan. 1, 1947



1947 Record Changer Manual

Nothing like it! Complete, accurate data on over 40 post-war models. Exclusive exploded views, photos from all angles. Gives full change cycle data, information on adjustments, service hints and kinks, complete parts lists. *PLUS*—for the first time—complete data on leading Wire, Ribbon, Tape and Paper Disc Recorders! 400 pages; hard cover; opens flat. Order now! **\$4.95** ONLY.....



Subscribe Regularly to PHOTOFACT Folder Sets

Here's the most accurate and complete Radio Data ever compiled—issued regularly two sets per month. Keeps you right up-to-the-minute on all current receiver production. Packed with extra help—full PHOTOFACT data on Automatic Record Changers—communications receivers—amplifiers—*plus* new PHOTOFACT Television Folders—exclusive, uniform coverage of popular Television Models, data proved best by actual service clinic experience. Subscribe at your Jobber today, for regular monthly issues. **\$1.50** PER SET, ONLY.....



Receiver Tube Placement Guide

Shows you exactly where to replace each tube in 5500 radio models, covering 1938 to 1947 receivers. Each tube layout is illustrated by a clear, accurate diagram. Saves time—eliminates risky hit-and-miss methods. 192 pages, completely indexed. **\$1.25** ONLY.....



Dial Cord Stringing Guide

The book that shows you the *one right* way to string a dial cord. Here, in one handy pocket-sized book, are all available dial cord diagrams covering over 2300 receivers, 1938 through 1946. Makes dial cord restringing **\$1.00** jobs quick and simple. **ONLY . . .**

FREE Cumulative Index

Send for the FREE Cumulative Index to PHOTOFACT Folders covering *all* post-war receivers up to the present. You'll want this valuable reference guide to the Radio Service Data preferred and used by thousands. Helps you find the Folders you want quickly. Get this Index at your Jobber or write for it today.



BOOST YOUR EARNING POWER!

Mail This Order Form
to HOWARD W. SAMS & CO., INC.
2924 E. Washington St., Indianapolis 7, Indiana

My (check) (money order) for \$.....enclosed.

- Send the RED BOOK. \$3.95 per copy.
- Send PHOTOFACT Volumes in DeLuxe Binder:
 - Vol 4. Vol. 3. Vol. 2. Vol. 1 (\$18.39 each).
 - Automatic Record Changer Manual, \$3.95.
 - Tube Placement Guide, \$1.25.
 - Dial Cord Stringing Guide, \$1.00.
 - Send FREE Photofact Cumulative Index.

Name.....

Address.....

City.....State.....

HOWARD W. **SAMS** & CO., INC.
INDIANAPOLIS 7, INDIANA

Are you Building a Business ...or Burning your Bridges?

Would you patronize a dentist who filled your teeth with plaster of Paris?

Would you trust your children's lives to a doctor who prescribed cut-rate pills?

Your business, too, is built on *customer confidence!* And your reputation is too valuable to risk with inferior or unknown products. The cost of the parts you use in the average repair job is insignificant com-

pared with your investment in your *reputation.*

That's why we say—**YOUR CUSTOMERS AND YOUR REPUTATION CAN AFFORD ONLY THE BEST! . . . SPRAGUE.**



CAPACITORS

SPRAGUE

*KOOLOHM
RESISTORS

* T.M. Reg.
U. S. Pat. Off.

SPRAGUE PRODUCTS COMPANY, North Adams, Mass.

JOBGING DISTRIBUTING ORGANIZATION FOR PRODUCTS OF SPRAGUE ELECTRIC CO.

**Reach for a SPRAGUE
and Know You're Right!**

The superiority of the new Sprague type TM High-Temperature Molded Paper Capacitors didn't happen by chance. You can use this better unit in your work today only because of more than four years of intensive research and one of the largest retooling programs in Sprague's history. That's why we can say "*The First Truly Practical Molded Paper Tubulars are Sprague TM's*"—and it is also the reason you can use them on any job with confidence and pride.

- Highly Heat Resistant
- Moisture Resistant
- Non-inflammable
- Conservatively Rated
- Small in Size
- Mechanically Rugged
- Completely Insulated

**UNCONDITIONALLY
GUARANTEED!**

You can stake your reputation on Sprague replacement parts. If used at rated capacitance and voltage, they are **UNCONDITIONALLY GUARANTEED** to give satisfactory performance. Insist on Sprague and get the best!

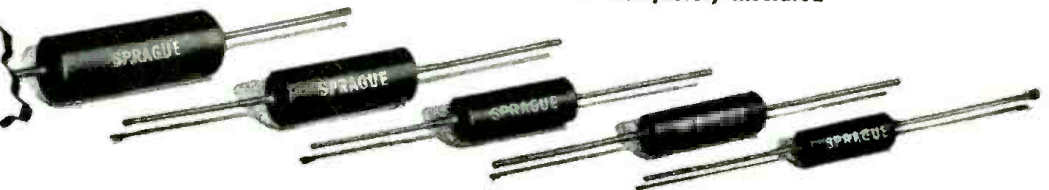

RADIO-ELECTRONICS for



After 20 years, RADIO-CRAFT takes new name

By HUGO GERNSBACK

Becomes



FOR some time past it has been apparent that the title of RADIO-CRAFT no longer reflects the editorial content of the magazine. When the publishers finally decided that a change was to be made, it was felt that, since the magazine first and last belongs to its readers, if any change was to be made they should have a say in any contemplated new title.

Accordingly, a letter was addressed to a representative group of RADIO-CRAFT readers scattered through the forty-eight states of the Union. The following is an excerpt from that letter which the writer addressed to subscribers last March:

"When in 1929 I started the magazine, the name RADIO-CRAFT was a 'natural.' At that period, radio was mostly constructional set building, amateur radio, etc.—a *craft*, in other words. But times have changed—so has radio and so has RADIO-CRAFT.

"The name today is a misnomer. On the cover since 1943 we print our slogan: '*Radio-Electronics in All Its Phases*,' and we wish to keep up with that definition. Indeed, we have great future plans for the magazine—more pages, color pages, *many more departments*, fully to justify our slogan.

"But the present name does not reflect the slogan. Many technical readers, engineers, the radio industry, advertisers, new readers—all have the impression that RADIO-CRAFT is still only a 'How-to-make-it', or a set-builder's magazine, because the title says so! Hence the absolute necessity for change in name.

"'Well,' you may ask, 'why don't we go ahead and change it?' The answer is: *We don't know which name to choose!* We have a list of names, many of which sound good *to us*—but how do they sound *to you, the reader?* We are too close to the picture to judge, and besides we build the magazine, *but we are not its readers.* No magazine staff ever is competent to take a detached view of its product.

"So we come to you and ask for your help in choosing a new name for *your* magazine—a name that will fit the magazine *better* than the present one.

"We here at RADIO-CRAFT feel that we do not have the right to change the name of your magazine without *first* asking the advice of a representative cross section of our readers, *particularly our older readers.*"

To the letter was attached a sheet listing twenty-three

titles. Our readers were asked to vote for the one they preferred and which appealed most to them. On the blank was a space for first, second, and third choice. Readers were asked also to suggest a title of their own which was not included in the list of twenty-three titles listed.

The first voting blanks were received on March 29. The final ones on April 26. The first day's votes totalled 776, the choice being RADIO-ELECTRONICS. Subsequent returns did not affect this choice in any particular, RADIO-ELECTRONICS keeping the lead from the first day until the final ballot was received. Only seven of the twenty-three suggested titles were runners up to RADIO-ELECTRONICS. These follow: 2. RADIO SCIENCE, 3. RADIO-TRONICS, 4. RADIONICS, 5. RADIOVISION, 6. RADIO WORLD, and 7. RADIOTELEVISION.

The vote for first choice came out as 58.8% in favor of RADIO-ELECTRONICS. The balance was broken up and scattered among the seven runner-up titles.

A large percentage of the returns were most enthusiastic about the title RADIO-ELECTRONICS; again these letters out-pulled all other recommendations.

At this point may we take the occasion to express our most sincere thanks to that great legion of our readers, who took the trouble to vote for the new title, as well as the hundreds who wrote long, constructive letters and their reasons for voting their particular title.

You will no doubt have noted that the change from RADIO-CRAFT to RADIO-ELECTRONICS was not sudden. It took four months to make the change. Beginning with the July issue the words "RADIO-ELECTRONICS" were featured underneath the old masthead, which from then on kept increasing in emphasis while the old title RADIO-CRAFT kept shrinking until with the present issue the change is complete. *We believe that the new title RADIO-ELECTRONICS expresses the contents of the magazine more accurately than could any other title.*

Radio-Electronics is a tremendous force in our present civilization. Yet, the radio-electronic age has only begun—it is still in its merest infancy. No man can tell the wonders still ahead and the discoveries still to be made in the radio-electronics field.

RADIO-ELECTRONICS magazine will continue to grow apace with the advance of its art—it will chronicle from month to month the latest advances from all over the world as fast as the printed word can bring these advances to you.

Ultra Loud Speaker Is Auto - Truck Size



Occupying the entire trailer front end, this horn is limited only by the power feeding it.

With a good amplifier, this unit can be heard two miles

By PAUL H. THOMSEN

sary for added strength. Considerable care was taken to make sure each shingle nail was driven into solid wood, for a loose nail might cause rattles or flexing. To avoid chipping, nails were never driven in near the edge of the Masonite.

One of the first and most important requirements of this mobile loudspeaker is that the roof of the trailer be absolutely waterproof. Any rotten lumber on the trailer must be replaced. If the roof leaks, it won't be long before boards will become loose and distorted; nails will not hold fast in rotten lumber.

Clear the trailer of all cabinets, partitions, and doors. Leave the housing over the wheel wells and leave the heater if one is provided and if it does not fall within the projector area.

The following quantities of clear white pine will be needed to build the mobile loudspeaker:

Quantity	Length (Feet)	Size
1	12	2 x 4
1	8	1 x 6
1	12	1 x 12
60	8	1 x 4
10	10	1 x 4

THE loud speaker is the most inefficient unit of a public address system. It is possible, however, to design a more efficient loud speaker by using a suitable air-coupling system consisting of a horn or baffle.

The complete loud speaker is composed of (a) the diaphragm, (b) the driving unit and (c) the section which is least considered by most PA men, the air-coupling system.

For mobile operation the weight and physical size of a loud speaker are very important. All these factors affecting the final results were considered in the construction of this mobile loud speaker system, designed and built by the writer.

There is a practical limit for ease of portability to the size of loud speaker projectors. In this system the size was limited to the tow end and right side of an ElCar 18-foot house trailer, as shown above. The lower frequency limit is approximately 35 cycles; excellent high-frequency projection is obtained up to

6,000 cycles since the projectors have exponential characteristics.

The next problem was to select some type of construction which would not exceed the weight-carrying limit of the trailer. The designer chose the airplane-rib structural method of obtaining rigidity with minimum weight. The rib structure had to be of sufficient strength to prevent vibration at its own resonant frequency.

Tests indicated that $\frac{1}{8}$ -inch-thick tempered Masonite would be satisfactory when reinforced with ribbing over its entire length. Clear white pine lumber was selected for the ribbing because of its low weight and because it is easy to work into shape.

The problem of securing these white pine ribs in place was solved by using shingle nails, which, with the proper amount of lumber, give sufficient strength and insure maintenance of the shape of the projectors. Wood screws and bolts were used only where neces-

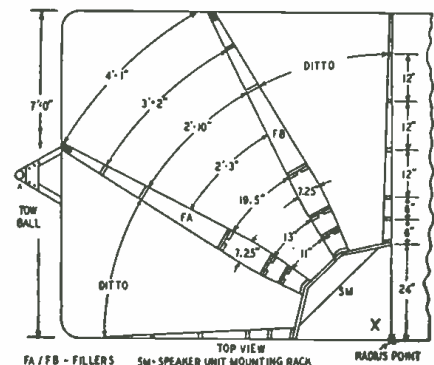

Fig. 1—Floor plan of triple speaker system.

RADIO-ELECTRONICS for

Material below will also be required:
 10 sheets 1/2-inch tempered Masonite,
 4 x 10 feet
 7,000 shingle nails, about 1 inch long
 3 dozen 1 1/2-inch No. 10 blued wood
 screws

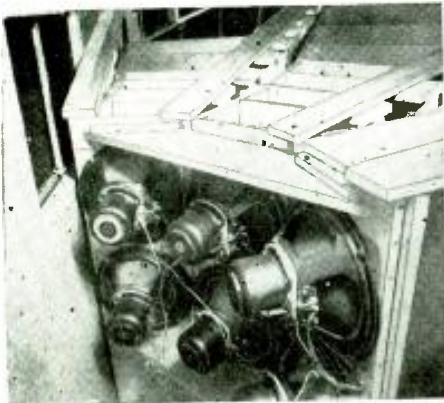

Fig. 2—How the six speakers are mounted.

- 1 gross 3/4-inch No. 6 blued wood screws
- 12 square yards of canvas
- 6 Rola type G12 or equivalent 12-inch, 20-watt loudspeaker units
- 1 quart quick drying enamel
- 5 lbs. window putty

Remove the inner wall of the trailer carefully within the projector area and make a careful study of all bracing so that all of it which can be used will be left in position. Park the trailer on a level plane, and remove the wall of the trailer through which the projectors are to extend. Use a saw and do not cut into the canvas top. See Fig. 1 for the floor plan and the size of the opening required. Be sure to provide vertical supports for the roof of the trailer. This will give you easy access to the section of the trailer where you will do most of your work.

Point X in Fig. 1 is the point where you should drive a nail from which all measurements should be made. With paint, mark all the dimensions on the floor exactly to scale. The speaker-unit mounting rack should be outlined on the floor and then the two outer walls of the projector. These dimensions are fixed and can be used as the working edges.

Next draw the floor lines of the inner vertical walls (A and B) of the two outside projectors. Remember that the dimensions given are the final values after the 1/2-inch Masonite has been added over the ribbed structure. The openings for the speaker cones are 10 inches. The contours of the fillers A and B should be roughly drawn, using the approximate maximum filler thickness of 7 1/4 inches as a starter.

A line should be drawn from Point X to the right front corner of the trailer. This line will be the center line for the center projector. From this line all points can be found for the left and right vertical walls of the center projector. Two 2 x 4 vertical roof supports should now be installed to carry the full weight of the roof of the trailer at this corner.

Fig. 2 shows the wooden mounting rack for all six loud speakers. Each pair of speakers is mounted on a piece of clear white pine lumber cut to the dimensions shown in Fig. 3. These three pieces are then mounted on the two pieces of white pine shown in Fig. 4. Prior to their installation within the trailer, all these pieces are screwed to-

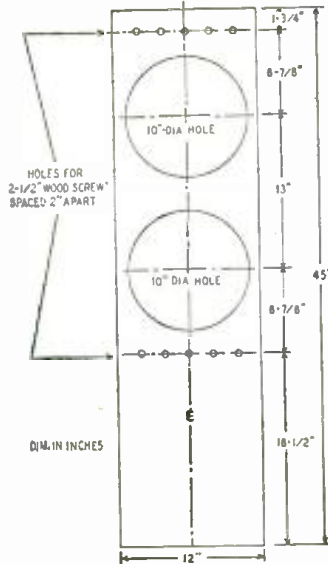

Fig. 3—Detail of one of the speaker boards.

gether for maximum strength. The six speaker-cone openings are covered with ordinary window screening to prevent anything from damaging the cones. This screening is tacked on.

It is suggested that you do not install the speaker units until you have completed all the carpenter work on the entire installation. However, the speaker mounting rack may be screwed to

the floor and left wall of the trailer. Then all floor markings should be completed.

Fig. 1 shows clearly that the ribs are closer near the speaker mounting rack than at the trailer walls. This is because the diaphragm of the speaker places more pressure on the walls in this area of the projector.

The ribbing is positioned every 6 inches up to the 30-inch rib. The ribbing in this area may be 2 x 2's or 1 x 4's with the thin sides facing the projector wall. Seldom were more than two or three nails used to hold each of these members in place. However, it is most important that each nail be of sufficient size and length to insure strength. At this stage of construction each member or vertical rib should withstand a horizontal pull of at least 100 lbs. without showing a tendency to break loose.

The vertical and top ribs are essentially the same, but it was desirable to use a separation of 6 inches for the ribbing on the bottom surfaces. This insured adequate strength for supporting

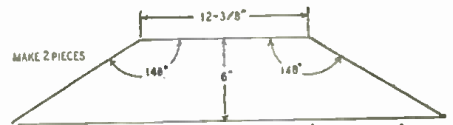

Fig. 4—Speaker board top and bottom pieces.

several boys and the builder during the construction and painting.

The designer of this mobile loudspeaker found that a tolerance of ± 1/32 inch was permissible up to a distance of 18 inches from the loud speaker mounting board. This could be increased to 1/8 inch at 36 inches. Where possible, a tolerance of ± 1/4 inch was held at 48 inches and 60 inches. Beyond this limit the contour was modified as

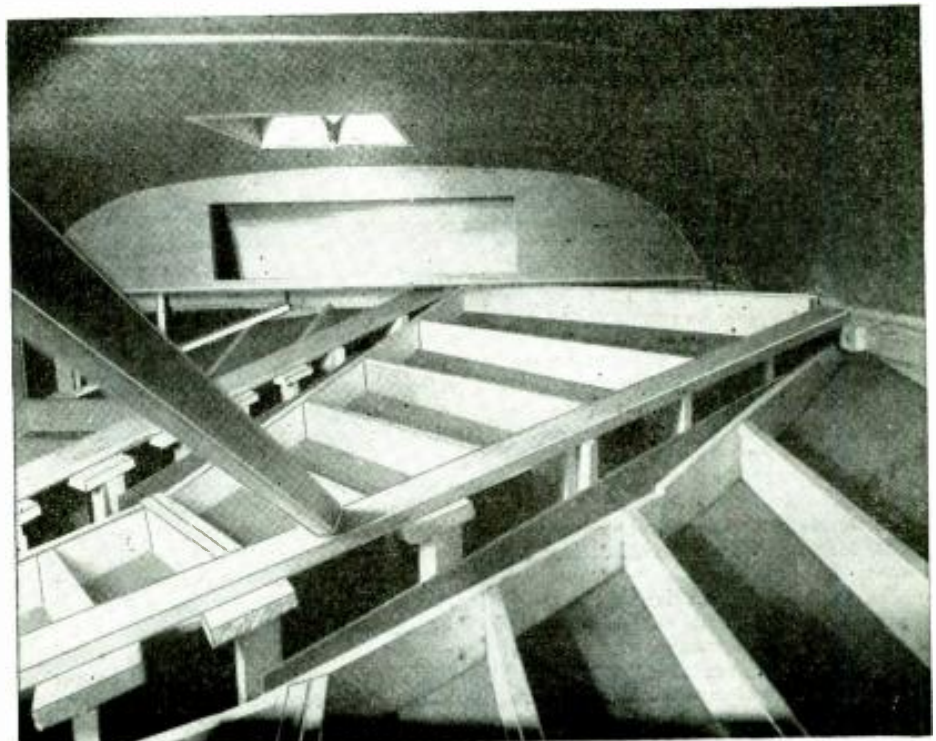

Fig. 5—This top view of the horns shows the construction details and framing excellently.

rapidly as the Masonite would permit without cracking to fill the opening in the trailer, as shown in the photographs.

Remember that the sound pressure on the surfaces of the projector is greatest near the loud speaker mounting board. For that reason extreme care was taken to fit the pieces properly. This

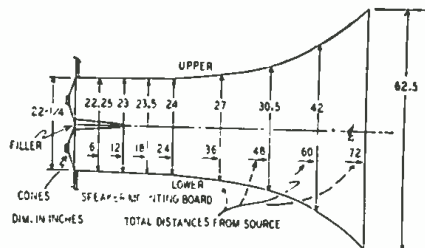

Fig. 6—Sidewall plan of the projector horns.

close fitting requires well-seasoned wood and careful nailing. Clamps were used during the nailing of the vertical ribs. It was found very convenient to use a piece of steel about 1 x 2 x 5 inches as a back stop when nailing into sections of ribbing that appeared to be springy.

Fitting the Masonite

After the vertical ribbing is finished, the vertical sheets of $\frac{1}{8}$ -inch tempered Masonite may be fitted in place. For convenience in handling, the pieces nearest the loud speaker mounting board should be not more than 30 inches long. The portion for the vertical panel contacting the loud speaker mounting board should be screwed on. Use $\frac{3}{4}$ -inch No. 6 blued wood screws for additional strength. The screws are placed in clearance holes spaced about 1 inch apart. The vertical sheets of Masonite are at least 4 inches above and below the estimated upper and lower horizontal surfaces of the projector (see Fig. 6). Pencil marks should be placed on the vertical ribbing approximately where the

upper and lower surfaces will fall. However, the horizontal center line on each side of the three projectors should be drawn in first to give a working line.

Since you have now covered the horizontal center lines on all of the vertical ribbing, it becomes necessary to draw this line on the inside surfaces of the three projectors. From this line draw again the upper and lower surface lines on the tempered Masonite. Make them clear. Now proceed to nail, above the upper line and below the lower line, a 1 x 4 white pine side mounting rail. If, due to the curvature of the side walls, you cannot fit the 1 x 4 close to the side wall through its entire length, cut it into shorter pieces (see Fig. 5). However, be sure that each piece is securely nailed to the vertical ribbing. It will be necessary to curve the lower edge of the upper mounting rail and the upper edge of the lower mounting rail to keep within the tolerances specified.

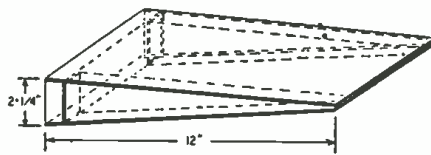

Fig 7—Construction detail of filler wedges.

To the upper and lower side mounting rails are toe-nailed horizontal 1 x 4 white pine supports. A minimum of 4 nails was used at the ends of the pieces. The inner edges of the pieces were shaped to follow the contours of the top and bottom surfaces.

As in the case of the vertical panels, small sheets of Masonite were shaped to fit in place to form the upper and lower surfaces of the projectors. To prevent rain from running down the top, a 2-inch strip of canvas is hung over the upper edge of the outer wall of the trailer.

The space between the pairs of loud speaker units is effectively removed, in so far as the load on the diaphragm is concerned, by placing a filler of two sheets of tempered Masonite between two or, preferably, three 11-inch wedges made of 1-inch clear white pine and then nailing all the pieces together and to a 1 x 10-inch crosspiece 2 inches wide, as shown in Fig. 7.

Previously it was pointed out that a tolerance of only $\pm 1/32$ inch was permissible. It is equally important to seal the corners of the projector near the diaphragm of the loud speaker where there are great pressures. Regular window putty or plastic wood may be used when the Masonite is dry.

The last job is installing the loud speakers. All the voice coils are connected in parallel, and the fields are so connected that all voice coils operate in phase.

The amplifier equipment was mounted in the rear of the trailer. Bear in mind the importance of balancing the weight on the trailer for ease of handling and greater safety. The gasoline-driven generator was placed in rear center to reduce the weight placed on the tow ball of the car. The operating table, preamplifier and equalizer rack and turntable were placed along one side of the trailer, with the main amplifier on the other side.

The photograph below shows the audio equipment within the trailer as viewed through the rear window. The 4-channel preamplifier, the Tonalizer or equalizer, the 8-day clock, turntable (recorder) all are in back of the microphone which is located on the operating table. The large power amplifier is located on the left. The monitor loud speaker can be seen in the upper left partition above one of the projectors.

Amplifier equipment

The power amplifier for this PA system should be able to deliver at least 100 watts of audio frequency over the frequency range of 30 to 6,000 cycles with relatively low total harmonic distortion. Tests indicate that distortion should be less than 5% at full power output. The equipment illustrated is capable of delivering 230 watts, class AB operation.

The full significance of the expression "Mobile Loudspeaker" will strike you when you get your first stationary PA job. Then and only then will you realize you need about 500 feet of microphone cable to permit placement of this speaker, not up on a telephone pole, but out in the lot several hundred feet away from the gathering. The relatively high projector efficiency along with good frequency response will insure not only adequate coverage of the immediate gathering but of several complete blocks.

The designer would like to suggest a 500-ohm T-pad on a 75-foot cable as a remote volume control. This permits anyone to monitor the volume from outside the walls of the trailer, more or less as it is heard by the audience.

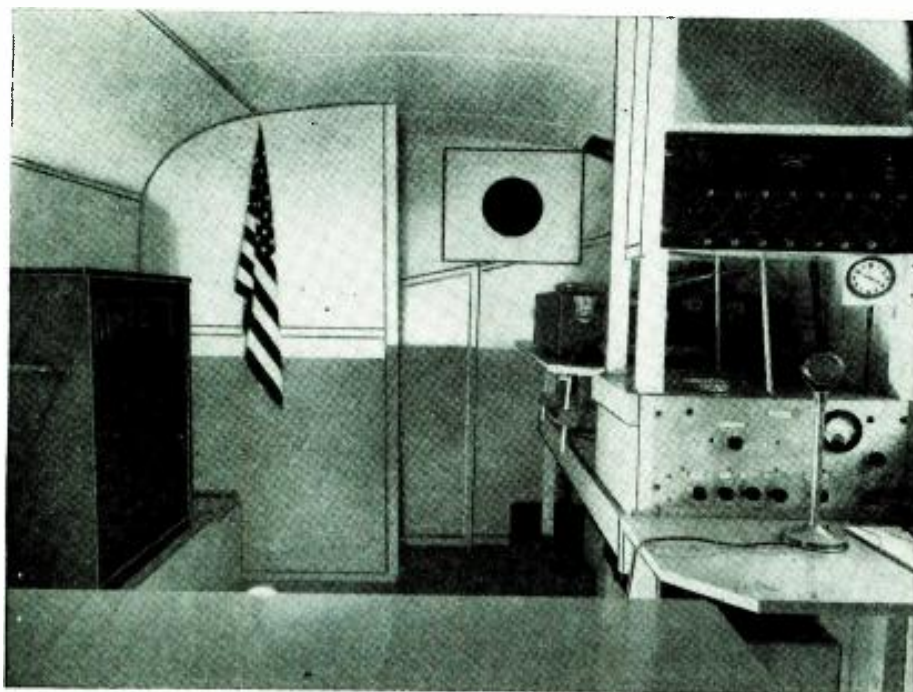

Inside the truck. The 230-watt amplifier is at left, the turntable and preamps at right.

MODERN MICROPHONES

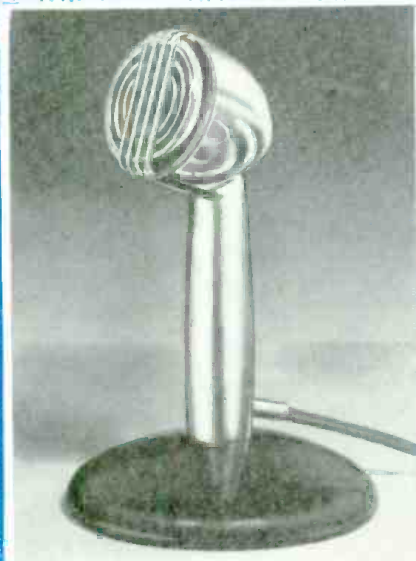

This is Astatic's Velvet Voice crystal unit, available as model 200 with flat response or 241 mainly for speech work.



This cardioid, Turner Model 77, has a front-to-rear discrimination of 15 db.

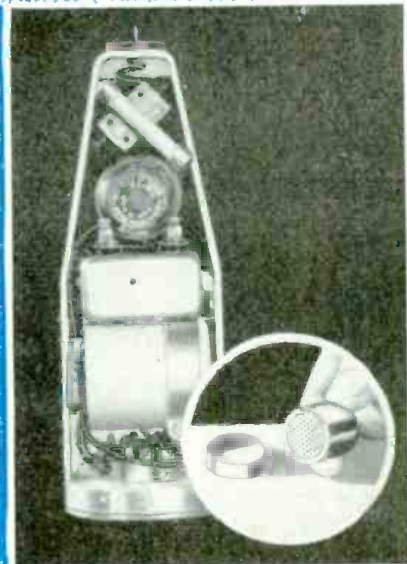

The amplifier is contained within the case of Western Electric's 640AA condenser mike. Mike (inset) screws on end.



The Stephens C-1 is a new condenser microphone that phase-modulates a crystal oscillator. Response extends from one-half cycle in 24 hours upward to 15 kc.



Amperite's R90 ribbon will not boom or blast. Its range is 40 to 14,000 cycles.



Astatic's Cardinal (crystal or dynamic) may be lifted from stand for hand use.

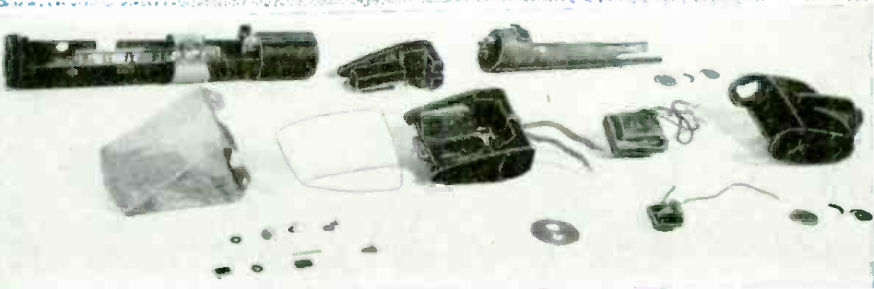

The new RCA Bantam velocity microphone shown beside its full-size fore-runner at left has the same output level and an 80 to 8,000-cycle frequency response. The exploded view above shows how the magnet is an integral part of the case.

Interesting Amplifiers



The Bell Model 2122 at left has three phono inputs. Two for magnetic units have the required bass equalization. The Fisher amplifier (right) has the Scott Dynamic Noise Suppressor. Electron-ray tubes show the action.



RCA MI-4297 voltage amplifier is made up of a group of one-channel subassembly units.

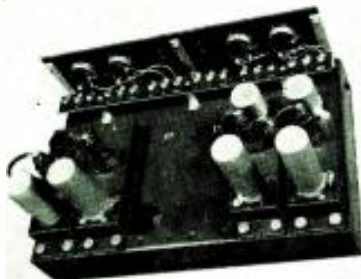

Knight 20-watt unit below has phono input only audio is flat through out the whole range.



RCA's portable SP-15A system includes a 15-watt amplifier with 1 microphone input and 2 channels for phonograph pickups. The carrying case for the amplifier has mike, stand, and cable. A loudspeaker is mounted in case cover.



Lafayette - Concord 2-131 is built especially for high-fidelity home use. FM amplifier, etc.



The picture above shows the Ward amplifier with both 45-watt power chassis installed. Operated in parallel, they furnish 90 watts.

Below is the Ward voltage amplifier. One or two of the power amplifiers may be added.

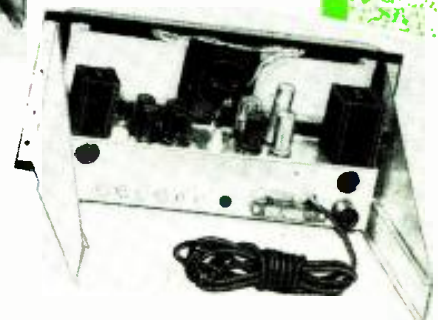

A convenient table lists 10 important features of 18 modern amplifiers. The text explains how to use the ratings.

THE accompanying table gives vital statistics on a representative group of commercially available amplifiers. A number of varied types are presented, phonograph amplifiers for the home, high-power PA units, and two-chassis preamplifier-power-amplifier combinations.

In selecting an amplifier, the purpose for which it is to be used should be kept in mind. That will insure that the quality of the unit chosen is high enough and—what can be just as important—that extra money is not spent for a higher-quality amplifier than necessary.

For phonographs in homes the pickup to be used (and the loudspeaker) should be considered. If an inexpensive crystal is the customer's choice or if he intends to buy a limited-range speaker, there is little point in paying for an amplifier flat to 20,000 cycles. If, on the other hand, the buyer is a discriminating listener who is willing to spend enough money to get a wide-range dual loudspeaker system and a modern magnetic pickup, he should not saddle himself with an amplifier that droops at the high end of the audio band. Pay attention to the harmonic distortion ratings, too. Even though moderate amounts of distortion may not be obvious to the ear, auditory fatigue, a condition which makes the higher tones appear to be unpleasant, will set in after a period of listening. No exact figure is worth anything in judging how much auditory fatigue will occur because different persons will be affected differently. In any case, for high-quality results, use an amplifier with the lowest possible distortion rating.

Harmonic distortion is a percentage figure which indicates how much harmonic energy will be developed when a pure sine-wave tone is fed into the amplifier. The distortion results from nonlinearities such as tubes which do not operate entirely on the straight portion of their characteristic curves, grid rectification, and unsymmetrical operation of push-pull stages. Some harmonic distortion is always present, largely because nothing in life is ever perfect. A total of 5% is usually defined as the maximum for high-fidelity amplifiers, but lower values are preferred.

Intermodulation is another type of distortion arising from nonlinearities. It occurs when two input sine waves produce sum and difference of beat frequencies. Beats will not be produced unless there is nonlinearity in the amplifier. If they are, the effect is one of creating new tones within the amplifier itself and feeding them to the speaker along with the original sounds. This is certainly

not fidelity. Most manufacturers do not give intermodulation ratings, so they were omitted from the table. In general, an amplifier with low harmonic distortion is likely to have comparatively little intermodulation.

In choosing an amplifier for PA work, the frequency response and distortion may or may not be important. Where the unit is to be used only for voice it is uneconomical to purchase a high-quality system. The same may hold true when it is to be used only for background music, as in a restaurant or hotel lobby. Volume controls are often turned down in these locations so that the music is not too obtrusive, or a.v.c. may be used.

Where live music is to be amplified high fidelity is usually demanded. Here distortionless reproduction through a flat amplifier is much preferred. But the loudspeakers in use may be a limiting factor, so much so that it may not pay to spend any extra money necessary for response beyond 8,000 or 10,000 cycles. On the whole, a serviceman who rents PA systems to various organizations will do well to have a high-quality unit, since quality will be needed in many applications.

Because of the well-deserved popularity of modern magnetic pickups, many of the amplifiers listed have input channels especially designed for them. These inputs have a higher gain than normal phono channels and some have the necessary 6-db-per-octave bass boost equalization. Some of the units which have magnetic pickup inputs are the Bell 2122, Altex A-323B, Newcomb HLP-14, Fisher, Concord 2-131, and the Masco MA-25EX. Almost all of these have either fixed bass equalization or variable controls.

The table indicates what type of equalization control is available with each amplifier. The buyer of a unit for almost any use other than in a broadcasting station will do well to look for bass and treble boost and cut controls. While a permanent flat response might appear to be most desirable for high fidelity, there is no denying that most microphones and loudspeakers are not linear. In addition, the room in which the sound is heard may be unsuitable. If, for instance, it has smooth unbroken walls, high tones will bounce around and may be very unpleasant to the ear. The only reasonable thing to do is to attenuate the highs. High-frequency cut also helps to reduce acoustic feedback and is necessary in matching the curves of most records for playback.

Bass boost is necessary too, in playing records with a magnetic pickup.

Bass attenuation will usually increase the clarity and understandability of speech.

All amplifiers which have variable equalizers or tone controls should have some mark on each equalizer dial to indicate the proper setting for flat response. Information from the most manufacturers did not mention this point but some of the amplifiers do have dots or zero marks to indicate the flat set-

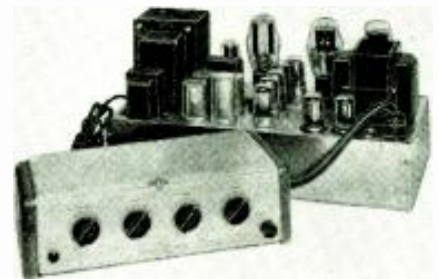

The Brook amplifier features separate preamp.

tings. When this point is not marked, a frequency run in the shop, using an audio oscillator and an output meter connected across a dummy load resistor, will enable the owner of the unit to make his own indicators. Spots of coding paint or red nail polish are convenient, and may be purchased easily in the very small quantities needed.

Several of the amplifiers have particularly interesting features. In the past most smaller amplifiers (with output power under 25 watts) were designed for small PA jobs and were not of high quality. Recently, much more attention has been paid to the phonograph enthusiast. Amplifiers with living-room-size outputs are being made to the highest standards. One of these is the Brook 10C3. The power supply and power amplifier are on one chassis which may be hidden away in a cabinet or a closet. The smaller unit contains the preamplifiers and all controls. It is attractively designed to be placed at some convenient spot in the living room. The low-impedance line between the two units can be of any reasonable length. Incidentally, intermodulation ratings are given on the Brook amplifier. The maker's data sheets show only 1.69% at the full 30-watt output, an extremely low figure. Whether or not this is due to Brook's policy of using only low- μ triodes throughout is a matter to be thrashed out between the two schools who hold (a) that all multigrad tubes distort and (b) that multigrad tubes need not distort.

One of the most respected high-fidelity amplifiers is the Altec Lansing

A-323B. Though the circuit is fairly standard, Altec claims that its special output transformers make a good deal of the difference. The unit is being offered now as a kit which includes the power and output transformers, the equalization coil, and a punched chassis and complete set of schematic and pictorial diagrams.

The RCA SP-15A is a complete portable system. The microphone, a desk stand, and the amplifier all fit into specially built pockets in the case and the speaker is mounted in the cover. The higher-power amplifiers are not usually small or light enough to fit into a case, so must be carried separately.

The serviceman who goes on many portable PA jobs will find it useful to make (or have a carpenter make) a special case for PA equipment. Ingenuity in making specially-shaped compartments and brackets for the various accessories will pay off in convenience. It is neither pleasant nor impressive to arrive on location entangled in miles of loose cable and carrying several objects in each hand, pockets bulging with more equipment.

Some of the amplifiers offered have

built-in volume expanders. The Knight 20-watt unit is one of these. The maker states that, contrary to the practice in most amplifiers, the degree of expansion in the Knight is not affected by the setting of the volume control. This may be a great convenience to listeners who turn down the gain momentarily to hear the doorbell or answer a question and find that the expansion control has to be reset.

Among the amplifiers listed which fall into the high-power class are the ACA-58D (52 watts) and the Ward Airline 45- and 90-watt jobs. The latter consists of either two or three separate units in a single metal cabinet. The preamplifier and one 45-watt power amplifier are furnished for the 45-watt system. To double the output power a second 45-watt chassis is added. Each power stage uses six 6V6-GT's in push-pull parallel. Two photos show how the preamplifier and power chassis are mounted. The preamplifier terminates in 600 ohms and a volume-indicator meter connected across this appears on the front panel.

Very few amplifiers provide various steps of fixed equalization selected by a

switch, as does the Newcomb HLP-14. This is in addition to variable tone controls. The switch has positions for records with various amounts of surface noise. No curves are given but presumably the switched equalizer affords proper compensation for the record characteristic plus some extra high cut in the "noisy" positions. In addition to the 14-watt amplifier listed in the table, Newcomb offers a similar amplifier with 30 watts output, the KXLP-30.

The Fisher amplifier incorporates the famous H. H. Scott Dynamic Noise Suppressor. Various refinements are added, such as separate electron-ray tubes to indicate action of the gates, and two-chassis construction. Three inputs can be accommodated but only one at a time. The desired one is selected by a panel switch. There are five controls associated with one form of tone control or another, enough to give any listener free rein in suiting the musical balance to his tastes.

The Masco 25-watt amplifiers are offered with (MA-25HF) or without (MA-25EX) a built-in expander. The same features are offered in 12-watt units, MA-12HF and 12EX.

AUDIO AMPLIFIERS

Mfr. & Model	Power output (watts)	Harm. dist. (%)	Output imped. (ohms)	Output stage	Frequency response (cycles)	Phono inputs		Mic. inputs		Equalizers (type)	Remarks
						No.	Gain (db)	No.	Gain (db)		
Altec A-323-B	15	2	2.5-24	p-p 6L6-G	20-20,000 ±1 db	1 1	117 77	use hi-gain phono input		bass boost treble cut	avail. in kit form
Amp. Co. of Am. 58D	52	5	2-500	p-p-par 6L6-G (4)	30-15,000 ±1 db	1	79	3 1	124 107	bass and treble cut	
Audar BMP-25	20	5	4, 8	p-p 6L6-G	50-14,000 ±2.5 db	1	65	1	110	treble cut	operates on 117 v. a.c. or 6 v. d.c.
Bell 2122	10	3	3.4-18	p-p 6B6-GT	30-15,000 ±0.75 db	4	60-80	0	bass and treble cut and boost	no mixers
Bogen PH-10	10	5	3.2, 8	p-p 6V6	40-15,000 ±1 db	1	72	0	bass and treble boost and cut	
Brook 10C3	30	1.3	1.5-500	p-p 2A3	20-20,000 ±0.5 db	1 3	100 80	0	bass, treble	separate preamp chassis
Fisher	20	1	8, 16	p-p-par 7C5	20-20,000 ±1 db					bass and treble cut and boost	dynamic noise suppressor
Knight (Allied 93-103)	20	2	4-500	p-p 6L6-G	20-20,000 ±1 db	1	78	0	bass and treble cut and boost	built-in expander
Lafayette-Concord 2-131	10	2	2-500	p-p 6V6	30-20,000 ±1 db	1		1		bass and treble cut and boost	
Lafayette-Concord	60	5	4-15	p-p 807	30-12,000 ±2 db	1	85	2	120	step-type	
Masco MA-25EX	25	5	4-500	p-p 6L6-G	30-20,000 ±1 db	1 1 1 1	90 60 70 75	1	120	bass and treble cut and boost	built-in expander
Newcomb HLP-14	14	5	3-500	p-p 6V6	30-15,000 ±1 db	1 1	90 109	0	bass boost treble cut and boost	automatic bass compensation
RCA MI-4297 (voltage amp) with MI-4288 (power amp)	40	2.5	4-250	p-p-par 6L6	30-10,000 ±1 db	0	2	111.5	bass cut	2 more inputs may be added
RCA SP-15A	15	5	4-250	p-p 6V6	50-10,000	1 1	75 100	1	114	high cut and boost	portable
Rek-O-Kut R-5A	9	5	8-500	p-p 6K6	50-15,000 ±1 db	2	76	1	125	treble boost and cut	for recording
Setchell Carlson PA-722	25		0.5-500	p-p 6L6	60-10,000 ±1.5 db	1	87	4	138	treble and bass cut	tone control for each channel
Stark	20	5	4-500	p-p 6L6	50-12,000 ±2 db	1	78	2	120	treble cut	Cabinet-top phono avail.
Ward	45	2	1.4-600	p-p-par 6V6 (6)	50-15,000 ±7 db	2	74	4	110	bass and treble cut and boost	90-watt model avail.

Modern Crystal Phono Pickups

Crystal pickups are still most popular

CRYSTAL pickups are still by far the most popular for home phonographs, probably because they are inexpensive and have high output. In higher-priced equipment the magnetic types are gradually replacing crystals but, since magnetic output is low, a preamplifier usually must be added.



The ceramic crystal pickup made by Sonotone.

ed. making the replacement job more than just a few minutes with a screwdriver.

Most crystal types differ only in the shape of the cartridge. The frequency response of the usual crystal gives medium to low fidelity because of an abrupt cutoff between 4,000 and 6,000 cycles and a number of peaks and valleys in the response curve. Theoretically, an ideal crystal has smooth response from ordinary records, tapering off smoothly in the upper register. The taper can be removed with simple RC networks. The Brush PL-20 is a good example of this type of crystal. Its cost, however, is far greater than that of the ordinary type of crystal pickup.

High-fidelity crystals, however, are making a comeback. The new Columbia LP (long-playing) Microgroove records are made with a frequency curve that approaches the ideal crystal characteristic closely. The first available record player for playing the Microgrooves was made by Philco in collaboration with Columbia engineers and uses a crystal pickup. Claims for the player (which also is sold under the Columbia label) state that the pickup will reproduce the Microgrooves ideally. Probably an R-C compensation network is included.

Astatic also produces a crystal pickup (FL-33) for Microgrooves. Like the Philco unit, the arm is constructed for stable operation with only 6 grams needle pressure. The crystal gives approximately 0.5 volt output, even with the smaller modulation present on the new records. Another maker of Microgroove pickups is Shure with its 900MG.

The Duotone Company has recently announced that their Star Sapphire and

Shockproof Nylon needles will be available with .001-inch points. Buyers of these should heed Duotone's warning that the new needle-point radius is not the only requisite for playing Microgrooves. The low needle pressure and the 33 1/3-r.p.m. turntable are essential. In view of modern research it is doubtful, too, whether any pickup using a conventional chuck to hold removable needles will afford the best fidelity.

The Rochelle salt crystal is affected by humidity, and its life may be shortened for that cause, especially in damp climates. A newer development, the P-N, or *ammonium dihydrogen phosphate* crystal is more durable. The P-N crystal is not damaged by high temperatures or humidity. Crystals have been demonstrated after immersion in boiling water.

Another new development is a ceramic crystal material composed of titanates of barium and other minerals. These are the high-dielectric ceramics used in small capacitors. Not all the properties

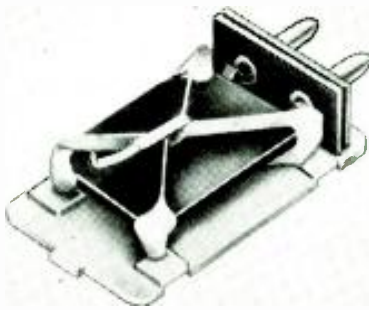

Electro-Voice Torque-Drive uses lever action.

of the titanate compounds have been fully explored as yet; therefore it is difficult to predict the possibilities of the new material. Advantages claimed by manufacturers of the new type pickup are low needle pressure, elimination of needle talk and wider frequency response.

The cartridge is much smaller than the Rochelle-salt type. This is said to permit a mechanical construction which causes less distortion, as well as lending itself to better design of the pickup arm.

Electro-Voice has developed a "torque drive" crystal pickup. Its stylus is coupled to a harness arrangement which, by lever action, distorts the crystal. (See illustration.) The harness is built so that vertical stylus movement produces no output, eliminating one source of surface noise. The lever action multiplies the torque imparted to it by the moving stylus so that lateral compliance is much increased. The response curve furnished shows a fairly smooth constant-amplitude response to 10,000 cycles.

Judging from the literature circulated by manufacturers, few crystal pickups today use the old standard steel needles. Some, such as the RCA Silent Sapphire, have permanent sapphire or special alloy-tipped needles built into the cartridge, but most offer cartridges with replaceable needles of their own special design. Many of these have "knee action," meaning that they are bent so that they have enough vertical compliance to eliminate any noise that would result from vertical irregularities in the record surface. Unfortunately, this usually adds some lateral compliance as well, adding slightly to the droop in the high-frequency response. The knee action does a great deal, however, toward reducing needle talk, direct acoustic radiation of record modulation, and noise.

Many of the new crystals are equipped with needle guards. These usually take the form of small spring-metal extensions or knobs on the lower surface of the cartridge case. When the knee-action needle hits the record too hard, it yields and the guard takes up the shock. One maker, Webster Electric, has redesigned the cartridge mounting for this purpose. The entire cartridge is spring-clipped into a special pivoted mounting screwed to the arm. Its normal position is at an angle to the record surface, as the drawing shows. When the pickup is dropped accidentally or is in any way subjected to a pressure greater than 2.5 ounces, the front end of the cartridge tips up and the small projection acting as the guard rests on the record. (See drawing.)

Despite guards and knee-action needles it is (still) a good idea to handle pickups gently.

One of the most useful features of recent pickups is a simple change in the method of connecting cartridges electrically. Formerly the leads had to be sol-

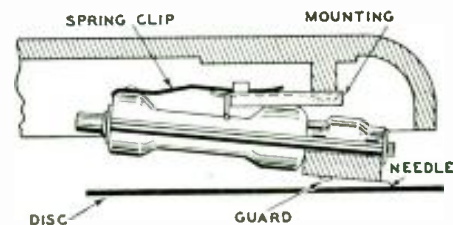

Webster cartridge has unique mounting.

dered directly to terminals. It was no difficult trick to overheat a crystal with the soldering iron and damage it permanently. Today virtually all pickups have plain round pins projecting from the rear. Small lugs are furnished separately, to which the leads are soldered. The lugs are then slipped over the pins. Danger of heat damage is eliminated and the serviceman's job is made much easier because he does not have to work in a tight place with his soldering iron.



Microgroove Phonograph Records

Technical characteristics of
Columbia's new high-fidelity
long-playing recording system

By M. HARVEY GERNSBACK

A SIGNIFICANT advance in commercial phonograph records was made when Columbia announced its long-playing Microgroove records late in June (RADIO-CRAFT, August, 1948). Up to 50 minutes of music may be recorded on a single 12-inch Microgroove record, compared with only 8 or 9 minutes on a standard 12-inch disc.

The new records differ from conventional ones in two major respects: First, they are recorded at 33 1/3 r.p.m. (standard broadcast transcription speed) instead of 78 r.p.m. Second, the number of grooves per inch is from 224 to 300, compared with about 90 in conventional records. This means that the groove width is approximately one-third that of ordinary phonograph records. That is shown clearly in the two photomicrographs Figs. 1 and 2. Fig. 1 shows a microscopic enlargement of a section of the new disc, compared with an ordinary disc in Fig. 2.

Recording at 33 1/3 r.p.m. introduces

certain fidelity limitations in conventional wide-groove recording. Fig. 3 is a schematic drawing of a disc surface. When the disc revolves under the cutting stylus at a constant rotational speed, the stylus will take the same amount of time to travel from A to A' if it is near the outer edge of the disc, as from B to B' if it is near the center, each of these distances representing the same fraction of a revolution. However, the actual *linear distance* traveled from B to B'—with the cutter near the disc center—is much smaller than that traveled from A to A', when the stylus is near the edge.

The drawing is much out of scale, but assume that the stylus travels each of these distances in 1/5000 second. If the tone being recorded is 5,000 cycles, the stylus will trace out one cycle in each case, as the drawing shows. Notice that the one-cycle groove of AA' takes up a comparatively long distance and its undulations are fairly gradual. But at BB' the same cycle will have to be traced in

a much shorter distance and its undulations are much sharper and its bends more acute.

Fig. 4 is an enlarged picture of each of these grooves. Notice that for AA' the width of the groove is fairly constant

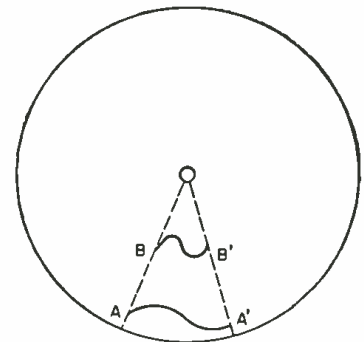

Fig. 3—Pinch Effect cause near disc center.

at all points. A reproducing needle of the proper size and shape will fit nicely into this groove and reproduce its variations faithfully. But for BB' the steeper bends of the engraved wave cause the groove width at points X to be perceptibly narrower than normal due to the shape of the cutting stylus. Because of this, the playback needle will be forced up out of the groove somewhat; it will not track properly, and the output volume of the pickup will be decreased. Distortion may also be introduced because the needle will move vertically as well as horizontally. This pinch effect will occur to some extent no matter what the frequency. In practice pinch effect is not bothersome at frequencies much below 1,000 cycles. If the playback needle point is a little larger than opti-

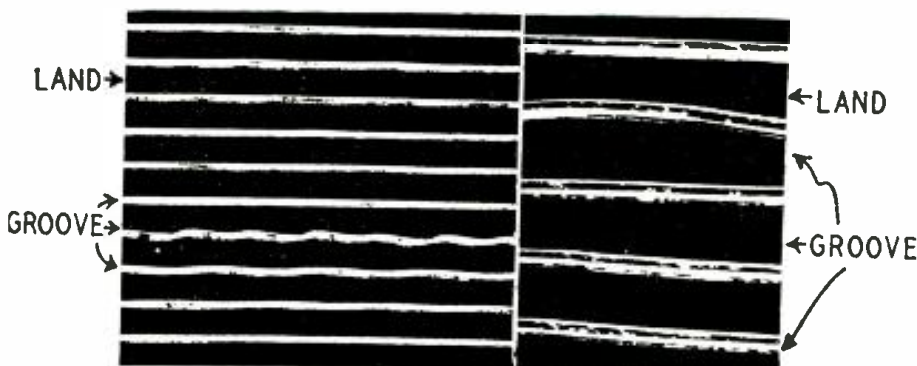

Fig. 1, left; Fig. 2, right—Photomicrographs of ordinary and Microgroove record section. Owing to variations in records, the ratio is nearer 2:1 than the more usual 3:1.

RADIO-ELECTRONICS for

mum, it will attenuate frequencies even lower than this. The actual attenuation due to translation loss in playback varies with the particular pickup and needle. Curves in Fig. 5 are typical.

Under a diameter of about 8 inches (in ordinary 33 1/3-r.p.m. recordings) the translation loss is so great that little correction is possible; but from 8 to about 13 inches, where the effect begins to be noticeable, diameter equalizers are used, when recording, to correct the response. These high-boost equalizers raise the amplitude of high frequencies fed to the cutter, the boost increasing as the stylus travels inward on the disc.

Because of translation loss, high-fidelity, 33 1/3-r.p.m. recordings (of normal groove width) are rarely made at recording diameters of less than 8 inches.

The frequency range which can be successfully recorded and played back without attenuation on a lateral-cut disc depends on four factors: speed of record rotation, modulation index (ratio of fully modulated groove width to unmodulated groove width), diameter of record at the innermost recording groove, and stylus tip radius. Decreasing the tip radius increases the maximum frequency which can be recorded, while decreasing turntable speed decreases the maximum frequency (for a given recording diameter and modulation index). In Microgroove records, turntable speed is reduced from 78 to 33 1/3 r.p.m., a ratio of about 1 to 2.3. But stylus tip radius is reduced by a factor of 1 to 3. Though the relationship between the two is not a direct one, the reduced stylus radius more than compensates for the speed reduction. Hence, even at the innermost diameter of the Microgroove records (5 1/4 inches) frequency response and lack of distortion is superior to old 33 1/3-r.p.m. recording at its innermost diameter, according to Dr. Peter Goldmark, director of engineering research and development at CBS and in charge of development of the records.

Curve A in Fig. 6 shows the recording characteristic used. It follows very closely the standard NAB characteristic (used in broadcast transcription work and in many standard records), except at frequencies below 100 cycles. These low frequencies are emphasized more than in the NAB curve. This reduces turntable rumble problems in low-cost record players, because the amount of bass boost needed is reduced. The records will reproduce almost perfectly without equalization when played through a high-grade crystal pickup fitted with a .001-inch radius stylus. The arm and pickup must be designed to track with a pressure of 1/5 ounce.

Because of the fine grooves, the maximum groove amplitude must be much smaller than in conventional recording. This means lower-level recording. Actual output level claimed by Columbia for these records is 4 db lower than conventional records. However, this lower level is not too important since the rec-

ords are pressed on Vinylite which gives practically no needle scratch.

The lack of needle scratch or background noise is aided by the phenomenally light needle pressure used in the phono pickup. The light pressure, combined with use of Vinylite discs, results in essentially noiseless record reproduction. With such a low noise level, it is not necessary to boost the level of low-

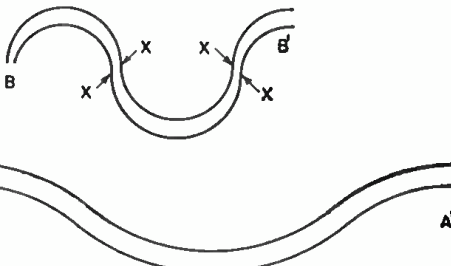

Fig. 4—Grooves of same frequency at different disc diameters.

volume sounds during recording. Instead, the volume level is set once and left alone. This is a particularly desir-

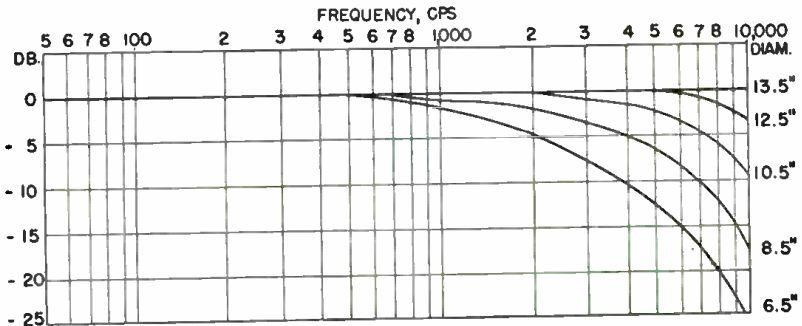

Fig. 5—Playback loss at various diameters.

able advantage in recording symphonic and operatic music, where much of the music's effect comes from the wide variations in volume. Columbia points out

the unit is an automatic record changer for 78-r.p.m. records and a manual record player for the 33 1/3 r.p.m. discs.

For those who already own two-speed

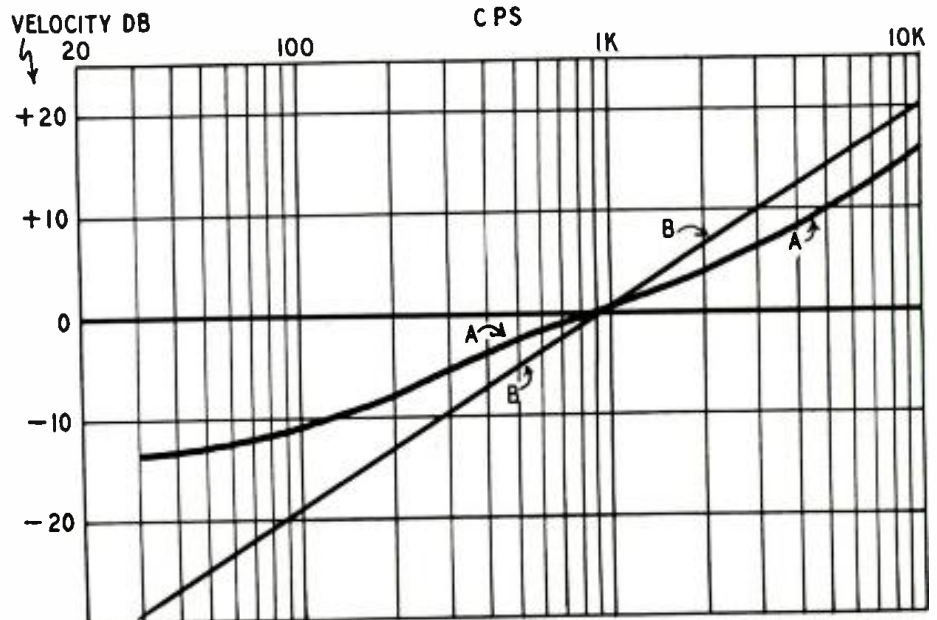

Fig. 6—Microgroove recording curve (A) vs. constant amplitude curve (B) of xtal pickup.

that no compression is used during recording. Listening tests on two Microgroove recordings have confirmed this. The dynamic range is much wider than

turntables, there are special pickups, both of the crystal and magnetic types.

— Figs. 3, 4, 5 are from Gernsback Library Book, "Practical Disc Recording."

This chassis holds the electronic heart of the organ, the FM oscillator and the discriminator. The tuning capacitor is mounted on rubber.

By WILLIAM K. ALLAN

reactance of S should be low compared to the total shunt resistance of R and the tube's grid resistor in parallel. Since capacitive reactance increases with decreasing frequency, the low-frequency response drops off.

Fig. 2 is the system described in the Merrill article. It shows how the string vibration can be used to frequency-modulate a carrier. The tube is connected as an r.f. oscillator, tuned by C1 and the coil. Across C1 are the series capacitors C2 and S, again our string (or reed) and pickup screw.

When the string vibrates, the capacitance of S changes at an audio rate. The changing capacitance causes the oscillator frequency to vary at the same rate, in effect giving frequency modulation. If the r.f. signal is picked up on an FM receiver, the string tone will appear in the loudspeaker.

In Fig. 2 C1 tunes the oscillator to its resting frequency. C2 is adjusted so that the vibrating string will produce the desired FM deviation. If C2 is large with respect to the capacitance of S, the effect of variations in S will be large, and vice versa.

An electronic reed organ

The principle illustrated in Fig. 2 was used by the writer to build an electronic reed organ. Instead of the piano strings, the vibrating parts are organ reeds. In contrast to the d.c. electrostatic system of Fig. 1, no high polarizing voltage is needed at the pickup screws. The insulation resistance between pickup screws and ground need not be high, so humidity and stray dust particles will have no effect. The unit has outstanding organ tone and full bass response. It is so simple and satisfactory that electronic music enthusiasts will be able to build it without difficulty.

If the amplification factor of a triode is 20, grid voltage changes are 20 times more effective than plate voltage

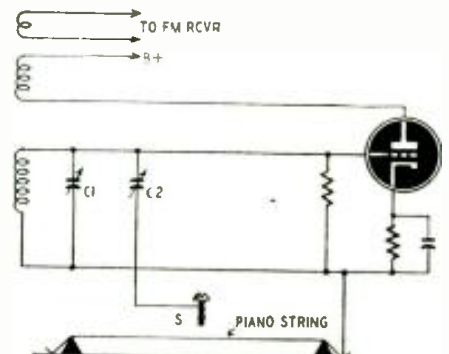

Fig. 2—One method of using FM for piano.

RADIO-ELECTRONICS for

Electronic Organ Improved With FM

AN OLD and well-known method of amplifying the sound of string or reed instruments is shown in Fig. 1. Several articles illustrating the method have appeared in RADIO-CRAFT. Among them are "Tone-Controlled Electronic Piano" by Bretsfelder, January, 1938 and "Electronic Organ" by Allan, April, 1941. "Non-Radio Uses for FM" by Merrill, April, 1942, described a different system which was used to build the FM organ described in this article.

The non-FM principle is simple. A polarizing battery B is in series with a resistor R and variable capacitor S, which consists of a piano string and a metal screw placed very close to it. (In an organ, the screw head is placed close to the vibrating reed.) When the string vibrates, the capacitance between string and screw head varies at the rate of vibration.

Since the amount of charge on the capacitor varies with its capacitance, electrons move from the battery to the string as its capacitance increases, and in the opposite direction as decreases. Current flowing through the resistor R causes a voltage drop across it, which in turn causes the voltage at C to vary at the string's rate of vibration. Since C is a blocking condenser large enough

to have a low impedance at audio frequencies, these changes of voltage appear on the tube's grid and vary its

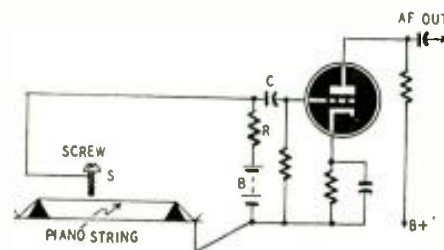

Fig. 1—Older pianos used polarizing voltage.

output. The reader will recognize the principle of the condenser microphone.

A separate screw is placed near each string of the piano (or reed of the organ) and all are connected in parallel to the amplifier input, usually by winding a single turn of a steel wire once around each screw. Output tends to be low, as the total capacitance change caused by the vibration of any one string is small compared with the total shunt capacitance of all the other screws and strings. The hum problem is often serious, and the high polarizing voltage may be dangerous. Insulation must be excellent—a great problem in humid weather. For good output, capacitive

changes in varying plate current. If the plate circuit is tuned by the pickup screws instead of the grid circuit (as in Fig. 2), 60-cycle hum is reduced by the tube's amplification factor.

The reactance of a .001- μ f condenser at 1800 kc is about 88 ohms. At 60 cycles it is 30,000 times greater. Employing such a condenser in series with the pick-

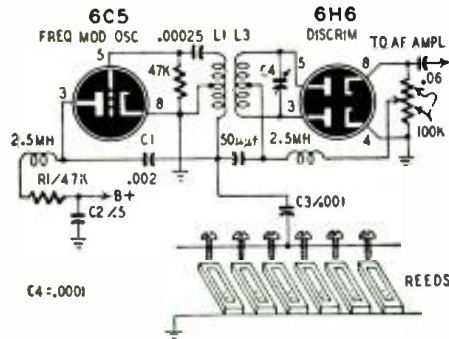

Fig. 3—Author's circuit needs no shielding.

up electrodes and the inductance they tune reduces the hum level over 44 db.

By combining these two hum-reducing devices (patent applied for) an organ can be built with no shielding. To appreciate what this means, the reader should have tried to adjust a conventional electrostatic organ in which the shielding had to be removed and replaced between each change and trial of the result, and for good measure he should have touched ground while trying to pull a reed polarized at 300 volts!

The change in the tone of a reed organ is remarkable. The organ may be played like a piano, the bass notes being struck so staccato that no audible sound is produced except when the electric pickup is on. The output sounds like a deep diaphone organ pipe.

Fig. 3 is the circuit. The 6C5 is connected as a shunt-fed Hartley oscillator, L1 being the center-tapped grid and plate coil. An r.f. coil from an old Victor t.r.f. receiver, chosen because it was wound in grooves and center-tapped, is about 1½ inches in diameter with about 48 turns each side of center tap, the total winding being 1½ inches long. The grid leak and condenser are 47,000 ohms and 250 μ f, respectively. C1 is the .002- μ f plate bypass condenser. R1 and C2 form a decoupling network. They reduce the output to a point where neighbors can't pick up organ music too loudly at 1800 kc on an all-wave receiver. C3 is the all-important hum-reducing .001- μ f condenser in series with the pickup screws which are placed over the grounded reed tongues.

The 6H6 is connected as a Foster-Seeley discriminator. L3 is identical to L1, placed with axis parallel to it and spaced about 2½ inches away. (See photograph at head of this article.) A midjet variable condenser resonates L3 to the oscillator frequency. It must be mounted on sponge rubber because it is sensitive to motion of any kind. It must be carefully tuned for best tonal output.

R.f. bypass condensers of about 100 μ f can be placed across each of the 100,000-ohm audio load resistors if necessary.

Constructing the organ

The constructor will be well advised to obtain a manual from an old reed organ. These can often be had for almost nothing at auctions or second-hand furniture stores. Choose a C to C reed organ, usually found in a piano case, in preference to an F to F, in case pedals are ever added. Remove the manual, taking care not to get the pallet opening rods separated from their proper keys. Remove the swell shutters and hinged stop-control covers.

Fig. 4 shows the tools necessary for placing the pickup screws properly over the reeds. A tool similar to that invented by Victor R. Mumma is made by grinding one end of an 8-inch length of ½ x

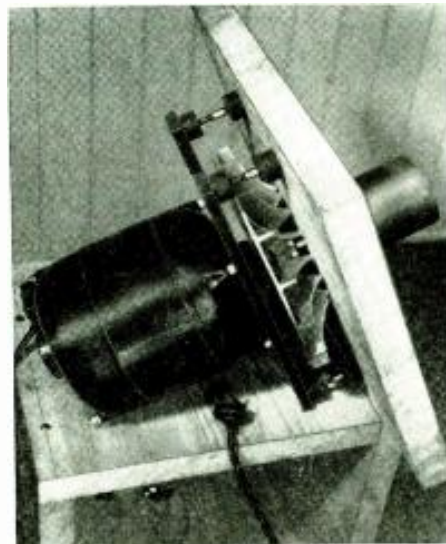

Fig. 5—Suction source is rotating impeller.

¾-inch iron to the thickness, width, and end curvature of the longest reed. With a hacksaw cut a slot down the middle of the opposite end, wide enough to insert a knife blade. Finally, bend the iron into a U so the tip of the slotted end lies exactly over the tip of the rounded end as in the center of Fig. 4.

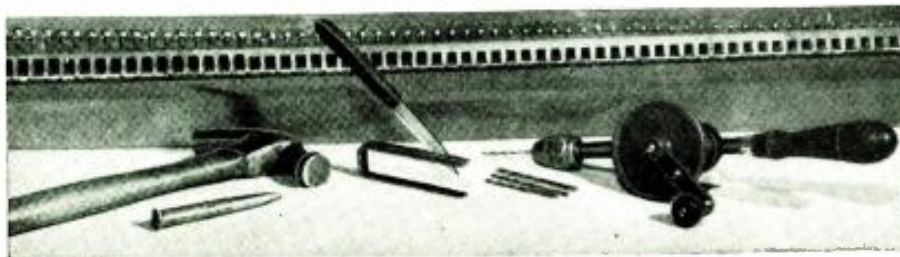

Fig. 4—Pickup screws are installed with these tools. The one in the center is home-made.

Pull out a reed. Insert the rounded end of the tool and, with a knife in the slot, mark the center line of the reed on the outside top of the reed cell. Also mark across the end of the tool on the outside top of the reed cell the position of the tip of the reed. Remove the tool and place the reed on top of its cell beside the center line with its tip against the end mark. With a center punch mark a point about one-fifth the length of the reed tongue back from the free end of the reed tongue.

Choose a brass machine screw about the same diameter as the width of the reed tongue and, with a drill slightly smaller than the screw, bore a hole through the top of the reed cell. Turn the screw into the wood so that it cuts its own thread as it goes. After blowing out any sawdust replace the reed in its

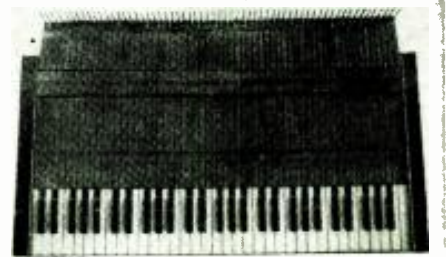

Fig. 6—Second reed action on the top manual.

cell. Repeat this process with all the other reeds. The bass reeds will use about No. 14-20 machine screws and the treble reeds about 6-32 screws.

Join all the reeds together to ground them by tucking flattened shielding braid underneath the ends of the reeds where they protrude from their cells. To guard against intermittent connections the writer soldered each of his reeds to the ground strip. A short piece of flexible wire to permit removal would probably have been better than soldering directly to a ground bus in case the instrument is to be tuned.

Operating adjustments

When all connections are made and the tubes are heated, make sure the oscillator is operating. It should light a neon lamp held in the hand and touched to the plate terminal, and the signal should come in strongly at about 1800 kc on a radio receiver. The standard test for negative voltage across the grid leak may also be made if a meter is available. The output of the discriminator may be connected to an amplifier or the phono jack in a radio. The volume control can be operated by the swells. A movie or broadcast attenuator stands up better than a receiver volume control.

Tune the discriminator condenser (C4 in Fig. 3) slowly and carefully while a bass reed is sounding. You will know when you hit resonance because with R1 shorted out, a 5,000-ohms-per-volt meter shows a change from +15 to -15 volts across the 100,000-ohm discriminator load resistors as the condenser passes through resonance!

If the oscillator's harmonics happen to heterodyne with the harmonics of any

(Continued on page 34)



A typical Brociner-Klipsch speaker system.

LLOUD SPEAKERS have come a long way since the days of the first metal horn types. Today there are high-fidelity speakers which reproduce the whole range of hearing, high-power projectors which will service large auditoriums, and an air-column unit that can be heard over a distance of 10 miles. All this in addition to the many standard units in sizes from 2 to 12 inches, with efficiency

New Trends in Loud Speakers

New developments in an old component

enough to fill a room with sound at less than a watt of excitation.

Prices for standard speakers are low enough to keep them from adding greatly to the total equipment bill. Special dual-unit systems run higher, in some cases overshadowing the cost of the amplifier and microphones. But even so, the figures are lower than for theatre systems which, for some years, were the only two-way speakers available.

Very few two-way systems are offered to the consumer with separately mounted woofer and tweeter. One of these is made by Stephens. This is the

P-52HF with a ± 5 db response from 40-12,000 cycles. Actual response extends upward to 16,000 and down to 30. The crossover frequency is 800 cycles. Horizontal sound distribution angle for the high frequencies is 80 degrees; vertical coverage is 40 degrees. These angles are provided by the 8-cell tweeter horn. The woofer is a 15-inch cone speaker with a 4½-lb. Alnico V magnet.

Another very interesting two-way speaker (the Klipsch) is an improvement on the old folded or re-entrant horns. The front of this speaker is a
(Continued on facing page)

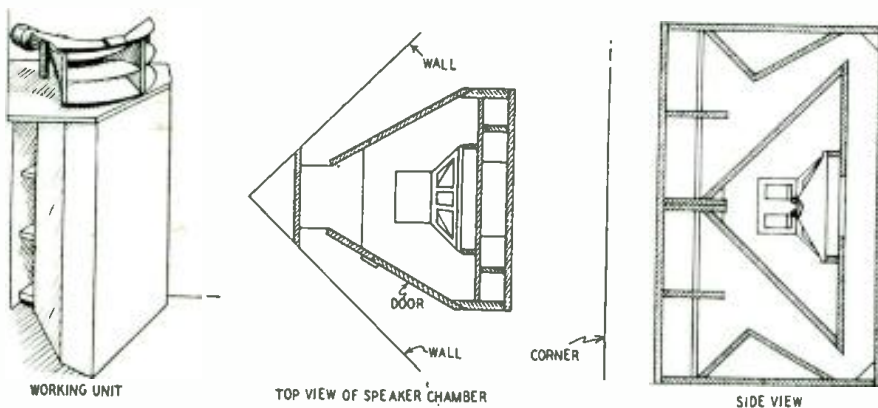

Construction of Klipsch speaker. Low-frequency sound comes from the vertical side slots.



The Altec-Lansing Model 604B duplex speaker.

(Continued from page 33)

strong local radio station. Dress the wire connecting the screws nearer to ground to shift the oscillator frequency, and retune the discriminator. Any two pieces of metal making intermittent contact with each other near the pickup screws (for example, octave-coupler rods) will create noise and must be avoided by all means.

A suction source was made from the impeller wheel of a junked airplane supercharger as shown in Fig. 5. An 8-to-9-inch-diameter fan is used for a 3,450 r.p.m. motor, and a 16-to-18-inch fan for a 1,725 r.p.m. motor. With this type of blower the wind chest with movable side is not required, regulation being automatic; but the suction line from the blower should be large enough and short enough to prevent a serious pressure drop on a heavy chord. Newsprint cardboard tube cores convey the suction, with old triple 8- μ f wet electro-

lytic condenser cans for couplings.

The writer discarded the keys which came with the reed organ and used a standard pipe-organ manual which has slightly wider keys. Just back of the ivory-covered portion of each key a hole was drilled, and a ¼-inch x 20 round-head machine screw was threaded from the top half down through this hole in the key. The pallet opening rods had their upper ends in the bottom of this hole so that turning the machine screw gave precise adjustment for opening of the level of the keys. Fig. 6 shows how a second reed action was added on the top pipe-organ manual by inverting the reed action and operating its pallet opening rods from the ends of extensions behind the pivot point or fulcrum on the rear of each of the pipe-organ keys. The ends of these extensions are slanted toward the center to allow for the difference in key widths. Bronze welding rod

with leather nuts acts as pallet opening rods.

The bottom of the wind chest was covered by a sheet of tempered Masonite or Presdwood, and an Amperite magnetic contact mike was placed on this Presdwood sounding board, inside the wind chest under the top treble reeds. Weight was added on top of the mike until the bass response extended to the bottom of the manual. This required a shoe-polish can lid filled with melted lead, except for the inch square opening for the mike cable. The result is a lovely contrasting reed tone obtained without danger of feedback if felt is placed over the outside but not touching the Presdwood.

If some of the direct sound from the reeds escapes to blend with that from the speakers, a very pleasant effect, resembling a string stop, is obtained. In fact organists have declared these stops to be among the most pipe-organ-like electronic tones they have ever heard.

RADIO-ELECTRONICS for

solid piece of wood. The sound from the low-frequency unit is emitted from two vertical slots that run the full length of the cabinet, which is placed in a corner so that the walls of the room form part of the horn. A wide-angle tweeter on the cabinet top supplies the highs.

Most high-quality reproducers are of the co-axial type, with the tweeter assembly built into the woofer. Space is saved by this arrangement without important sacrifice of frequency range. Usually the tweeter unit is a separate metal-diaphragm driver with multicellular horns to disperse the sound over wide vertical and horizontal angles.

The Altec-Lansing 604B is an excellent example of this. As the photograph shows, the high-frequency horn is within the large cone. A separate small case contains the electrical network which divides the audio band into high frequencies, channelled to the tweeter only, and lows, which go to the cone speaker only. The assembly can be mounted in a standard bass-reflex cabinet with no more difficulty than a standard single speaker. It is designed to cover a spectrum from 30 to 15,000 cycles.

Because of the multicellular horn, the angle of coverage for the high frequencies is 60 degrees horizontally and 40 degrees vertically. This is an important point because treble sounds tend to travel in straight lines. With ordinary speakers, the listener must stand practically right in front of the unit to hear the full range. With the multicellular horns it is usually possible to place the speaker in the room at some point where almost all of the area will be covered.

Jensen was probably the first manufacturer to make coaxial speakers for home use. The Jensen JHP-52 is a 15-inch cone speaker with a small cone speaker mounted at its center on a spider support. The angle of sound distribution in the Jensen is much like that in a single speaker, requiring the listener to be on the axis for best results. The Jensen system is much less expensive than those using multicellular horns. It covers a 50-12,000-cycle frequency range.

One of the most interesting speaker developments is the compressed air type, built on an entirely different principle from most units. Air is pumped to the speaker horn by a compressor at constant pressure. The airstream is modulated by two slotted grids, one movable and one stationary. A small armature is attached to the movable grid. The output of a 20-watt amplifier is connected to the voice coil, which moves in accordance with the audio impulses and pushes the movable grid in and out. The pressure of the air emerging from the speaker horn is varied by the movements of the grid, much as the air from the lungs is controlled by the human vocal cords.

The sound output of one typical compressed-air system is equivalent to that of an ordinary 500-watt PA system, though only 20 watts of audio is supplied. The signal, despite the horn, is strong in all directions, though strong-

est on the horn's axis. Frequency response is especially designed for best speech intelligibility, extending from 250-5,000 cycles with the 4½-foot horn.

The MI-6269A is an interesting RCA development. Much of the distortion in speakers is caused by resonance of the cone and by its stiffness. Some of this is remedied by the new method of mounting the cone. Instead of cementing it to the circular edge of the metal frame, the designer has attached a flexible paper skirt to the cone's edge and fastened the other end of the skirt to the frame. An iron ring guard protects the cone from damage. Since the entire cone can move instead of only the inner part, the frequency range is increased as much as an octave over response with conventional cone mounting.

A speaker of remarkable appearance, pictures of which have just been received from Italy, is referred to as an *expansion* loudspeaker. Although the manufacturer neglected to give any details of its operation, it would appear to have a horizontal moving coil in the pot magnet at the base and a stylus running to the top of the globular or ellipsoidal "cone." Audio signals acting on the voice coil would then lengthen and shorten the vertical axis of the globe, causing it to expand and contract at its equator. The manufacturer claims—with apparent justice—equal propagation over an angle of 360 degrees, and further claims advantages over the standard cone speaker in reproducing high frequencies.



Accordion-type speaker, an RCA development. Cone floats freely on a flexible-paper rim.



An Italian novelty—the expansion speaker. It is claimed to be completely omnidirectional.



The compressed-air speaker works like the human voice, with lungs, larynx and vocal cords.

Stability due to inverse feedback and gain of more than 100 decibels in a 15½-pound amplifier

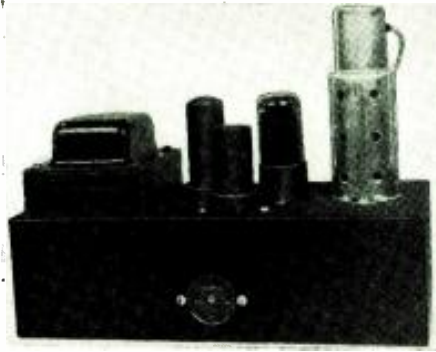

Four-Watt Portable For All-Around Use

By LYMAN E. GREENLEE

THIS little amplifier can be built easily and cheaply and has many uses. It is suitable for a small PA system, as a recording amplifier, or as a musical instrument amplifier. The model shown in the photographs was built on a 5 x 9½ x 3-inch chassis which just fits a 12 x 12 x 7-inch portable speaker case, leaving room for a 5-inch speaker. The completed unit weighs 15½ lbs. This includes everything except the microphone and stand.

The frequency response is very good, hum level is unusually low, over-all stability is excellent, and still the cost of construction remains extremely small for an amplifier with a gain of over 100 db. The model used a 6SJ7, 6F8-G, 6V6, and 6X5, but equivalent tube types may be substituted. A 7C7 may be used in place of the 6SJ7 or 6J7, a 6SN7 or 7N7 may be substituted for the 6F8-G, a 7C5 for the 6V6, and a 7Y4 or 6X5-G for the 6X5 rectifier. If a suitable power transformer is available, an 80 or equivalent rectifier may be used with identical results.

The diagram is shown in Fig. 1. This circuit, originally consisting of a 6SJ7 and 6V6, was later modified to use a 6F8 and 6V6. Since neither of these arrangements gave sufficient gain, the 6SJ7 was restored.

This circuit is very stable, yet filtering has been reduced to a minimum. Note that the 6SJ7 is operated with cathode grounded, giving greater stability and less hum. A small bias cell was originally used, but it was removed with a resulting improvement in performance. Note also the absence of bypass condensers in the 6F8-G cathode circuits, and the feedback arrangement to the 6F8-G output-section cathode. Using inverse feedback greatly enhances the performance and improves

stability. Another factor contributing to stability is the short leads. It is necessary to shield the input to the 6SJ7 and also to the 6F8-G. A tube shield will be required for the 6F8-G.

All grounds should be brought to a common bus which is connected to the chassis at the 6SJ7 socket. The 6V6 and 6F8-G tubes are slightly overbiased for increased stability. Actually, 250 ohms and 2,500 ohms would normally be used in place of 300 ohms and 3,000 ohms respectively. In some cases it will be desirable to omit the 25- μ f condenser across the 6V6 bias resistor, or to decrease its value to 10 μ f. This will of course depend somewhat on the use to which the amplifier is to be put. For use as a speech amplifier, the condenser may be left out entirely.

The method of obtaining a fixed bias for the 6V6 is rather unique. It uses a selenium rectifier connected to one side of the power transformer secondary.

The resistance values given will be correct for a power transformer having a 700-volt center-tapped secondary. For lower-voltage transformers it will be necessary to reduce the value of R1. Check the bias voltage until a resistor is found which will give 12.5 to 15 volts.

Measurements of bias voltage should be made with a v.t.v.m. connected between the 6V6 grid and ground with input to the amplifier shorted, and also across C1.

The use of fixed bias permits a larger undistorted power output and enables the amplifier to drive a 12-inch speaker. The improvement in tone quality is so noticeable that it is well worth the extra cost involved. Owing to the high values of resistance used in the bias bleed-off circuit, the unbalanced load on the power transformer is slight, and the selenium rectifier is operated well below its maximum voltage rating. It is important to use good electrolytics having

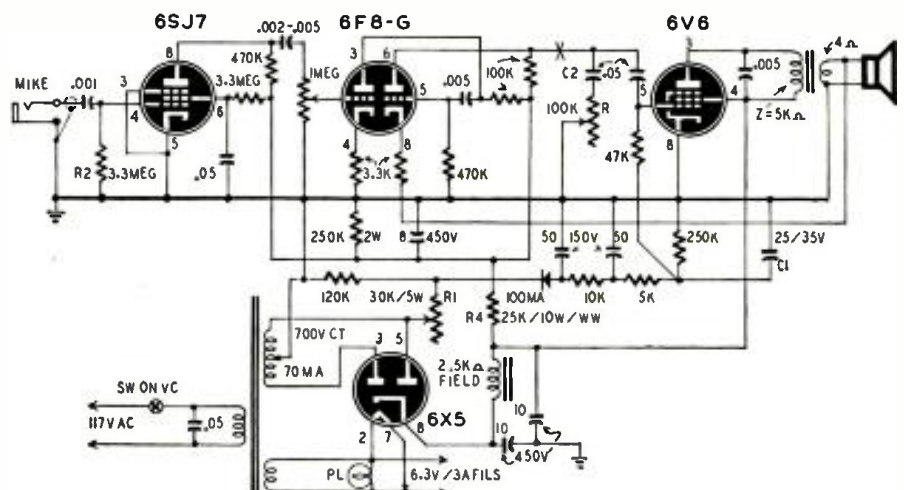
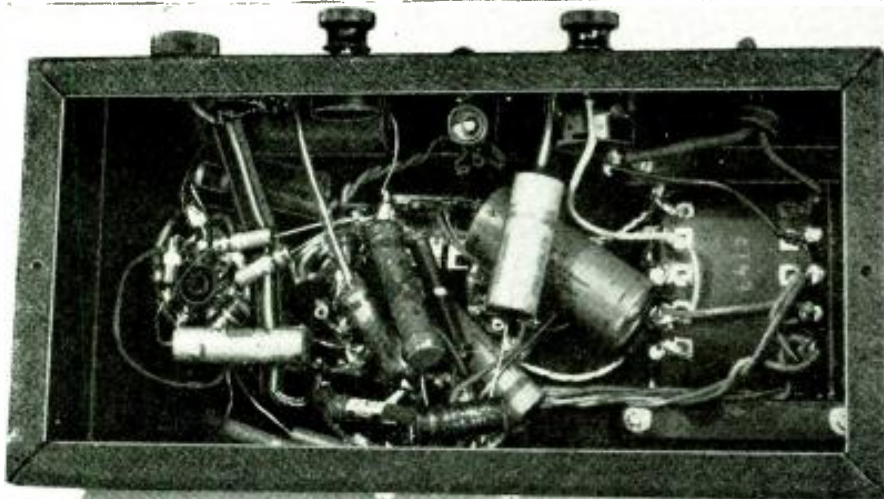

Fig. 1—The schematic. Break in plate circuit of 6F8-G is for alternate connection of Fig. 3.

RADIO-ELECTRONICS for



Bottom view of the portable amplifier shown in the two photographs on preceding page.

low leakage; otherwise the bias voltage will probably be too low.

If a phonograph input is to be used, the pickup should be coupled to the 6F8-G input rather than through the 6SJ7; otherwise the gain will be excessive, with resultant overloading. The best method of coupling is to use a potentiometer with a grounded center tap, as this permits fading from micro-

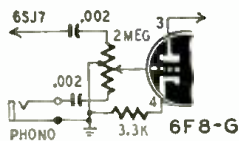

Fig. 2—Fader for a phonograph input.

phone to phonograph pickup. Fig. 2 shows such a connection. Nothing is heard when the fader arm is at center.

Input resistance R2 in the grid circuit of the 6SJ7 is shown as 3.3 megohms. This value may vary from 1 to 5 megohms, depending on the response and sensitivity wanted. If the gain is ex-

cessive, reduce this resistor to 1 megohm. The size of the 6SJ7 plate coupling capacitor will affect the bass response. Unless it is desired to accentuate the bass, it can be left at .002 μ f.

The .005- μ f condenser across the output transformer cuts down the tendency to squeal and gives a more normal response with the 5-inch speaker. If a larger speaker is used, it may be desirable to omit this capacitor.

R-C2 is an ordinary tone control. Alternative tone compensation is shown in Fig. 3. This circuit, connected at point X in Fig. 1, permits attenuation of both bass and treble frequencies. There is a loss in gain with this equalizer, and

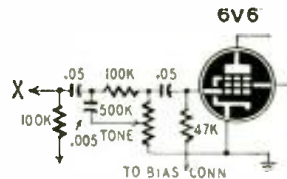

Fig. 3—Circuit for better tone compensation.

A Synthetic Bass Note Circuit

MANY music lovers object to small radios and phonographs because most of them lack good low-frequency response. The low notes are lacking because small speakers and inadequate baffles must necessarily be used in small cabinets. Adding tone controls to accentuate bass is not the solution because excessive low-frequency power overloads the speaker and causes boominess and distortion. A novel circuit used in the Sonora Model RCU-208 produces the effects of bass notes synthetically. The a.f. circuit of this receiver is shown in the diagram.

Low notes are boosted by the low-pass positive feedback network R1, R2, R3 and C1. Positive feedback increases the nonlinearity of the tube to which it is applied. This increases the odd harmonic content. Assume that a strong 35-cycle note is passed through the circuit with the tone switch S1 closed. This removes the feedback, and either the

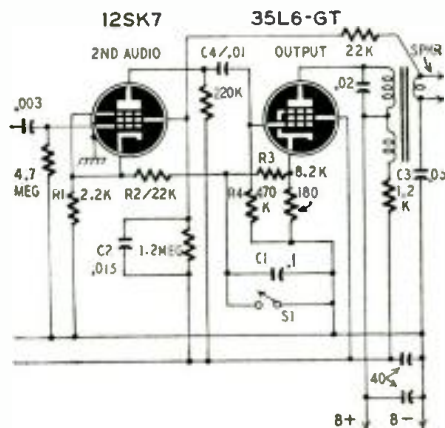

Diagram of the Sonora synthetic bass circuit.

speaker would be greatly overloaded or the note would not be reproduced because of the inadequacy of the speaker. With S1 open, odd harmonics of 35 cycles

it might be undesirable for some applications. In the upper position of the potentiometer arm the high frequencies are accentuated by the low reactance of the .005- μ f condenser across the 100,000-ohm resistor which is in parallel; while in the ground position, the high notes are effectively bypassed by the .005- μ f condenser.

The power transformer's high-voltage winding should have a current-carrying capacity of at least 60 ma, and the heater winding should supply 3 amps. The 2,500-ohm speaker field used as a filter choke gave 250 volts for the 6V6, but a field of 1,500 ohms or even less might be more suitable. It may be desirable to reduce the value of the decoupling resistor R4 from 25,000 to 15,000 ohms. The value of this resistor will depend partly on the amount of leakage across the 8- μ f filter condenser, and in some cases the voltage drop across 25,000 ohms will be excessive.

No definite constructional details are given, other than those revealed by the photographs. Actually, it is possible to use a smaller chassis as there is plenty of vacant space available. Better results would be secured by using a larger speaker and better baffle system, but such a system would add to the weight and decrease the portability of the unit.

For most applications, a good directional microphone should be used. This is especially important if speaker and microphone are to be operated in the same room.

If a speaker with other than a 4-ohm voice coil is used, it may be necessary to insert a voltage divider to reduce the amount of feedback. Such a divider may consist of two 4,700-ohm resistors in series across the voice coil with their mid-point connected to the 6F8-G cathode. One side of the voice coil must be grounded. This connection will provide a voltage divider suitable for 6-12-ohm voice coils.

(105, 175, 245, 315, etc.) will be produced. The coupling condenser C4 is relatively small to attenuate the 35-cycle fundamental so it won't overload the speaker.

The human ear is a nonlinear device that produces harmonics of notes it hears. If the ear hears notes harmonically related to some low note, it re-creates the fundamental that would have produced them. This synthetic bass circuit takes advantage of this effect. The ear hears low notes that are not produced by the speaker.

Negative feedback between the screen grid of the 12SK7 and the voice coil lowers the dynamic plate resistance of the 35L6 and reduces the effect of changing output impedance. Hum from the positive supply is reduced by feeding it to the screen grid of the 12SK7 through C2 and C3. Values for these capacitors are chosen so the hum voltage bucks out the hum on the plate.

Packaging and Unitizing Audio Equipment

By ERIC LESLIE



The console below in use at a large industrial plant.

AS the technical problems in any type of radio equipment are solved, designers and manufacturers find it possible to pay more attention to the manner of packaging and to the container itself. The early radio receiver was an aesthetic atrocity—today it may be the finest piece of furniture in the room. Preoccupation with technical problems in

early television receivers was no doubt the reason for neglect of the cabinet—a neglect which caused some women to refuse to have a receiver in the house. Together with cabinet appearance, unitization is becoming an increasingly

evident trend. One large television manufacturer (Admiral) is featuring equipment which can be bought a piece at a time as the purchaser's finances permit.

Unitization and packaging have recently been receiving considerable attention in the sound field. A number of amplifier manufacturers are now producing equipment which can be increased in size by units from a very small to an extremely large amplifier. At least two unitized types of "containers" have been featured recently—one in the industrial field by RCA, the other in home sound equipment by Jensen.

The RCA unit-built console is made for industrial plants, large schools, hospitals, hotels and similar establishments. In its simplest form it is the sound control panel with a bank of 16 zone switches (permitting paging to 16 speakers) shown in Photo 1. A two-unit console, almost exactly similar in appearance, provides a dual-channel control panel with paging facilities to 64 zones. In the third step addition of a record-transcription pedestal makes possible distribution of speech and phonograph music and in the fourth, shown in Photo 2, a second transcription pedestal and a radio tuner provide facilities for fading music in and out, as well as supplying live speech and radio programs to 128 zones.

A number of amplifiers are adapted



Photo 1—Simplest form of the RCA console.



Photo 2—This console provides two turntables, an all-wave radio and wide paging facilities.

RADIO-ELECTRONICS for



Photo 3—The Jensen reproducer cabinet.

to the unit-built system, though they may not necessarily have been designed to work with it. For example MI-4288 and MI-4297 described in the table on page 28 may be used in many installations. There is space in the pedestals for pre-amplifiers, and for a number of special effects generators (time signal, electronic siren, fire signal) which are available if required.

The Jensen Customode

The Jensen equipment consists of four basic wooden cabinets. One of these—the bass reflex reproducer (Photo 3) is designed to accommodate the manufacturer's 15-inch loudspeaker units. It may be used in either a vertical or horizontal position. It is 36 inches in one dimension, 24 in the other. All Customode units are 18 inches deep.

The other basic units (shown in Photo 4) are an open-front record cabinet with three shelves, and two utility cabinets, with hinged fronts. One of these is 24 inches long, the other 18, and both are 12 inches high.

They provide sufficient space for receivers, record players, recorders, amplifiers and any other equipment the high-fidelity enthusiast, experimenter or apartment-bound amateur may require. Photo 5 is a composite which uses all the units—record cabinet at left, reproducer in center, small cabinets at right and medium cabinet above. Innumerable other arrangements could be built up from the basic units. An almost limitless number of combinations is indeed possible with these cabinets. The simplicity of design will also doubtless start many a home constructor on the road to a neat and unitized layout of his own equipment in simple home-built cabinets.

Doors hinge at the side on the small cabinet, drop down on the large one (to form an operating table if required). Motorboard and slide assemblies may be used instead of doors for cabinets intended to hold phonographs or recorders.

Hybrid equipment employed

A notable feature of both the above systems is that while they are designed to work with the manufacturer's own equipment, they may be used equally well with apparatus the purchaser already has on hand. Another manufacturer (Lafayette-Concord) has gone a step further in its unitized sound equipment designed for industrial plants. One of the company's standard Lafayette-Concord amplifiers is installed in the lower part of the assembly of Photo 5, while a Browning FM-AM tuner in the top section supplies FM and AM music for distribution. The microphone is for paging.

A number of other interesting unitization and packaging experiments are being put forward. In some cases unitized chassis are seen. This method of construction was first brought to public attention during the war with the Harvey unitized radio (RADIO-CRAFT, November 1943). Each stage of that radio was a separate unit. A number of units were strung side by side on bus wires to make up a receiver.

In some of the modern amplifiers, such as the Ward illustrated elsewhere in this issue additional chassis are placed behind each other. One or several of these can be placed behind the same panel, as on certain RCA and Airline amplifiers. Amplifiers can be built up to higher powers, additional pre-amps added, or defective sections removed for servicing, with a facility impossible in more rigid equipment. As competition for the sound market increases, we may expect to see a number of totally new designs in the direction of better and more versatile packaging and unitization.

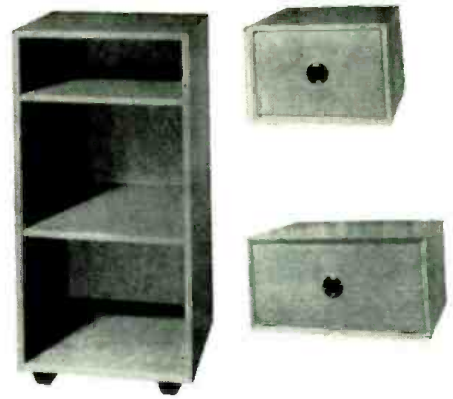

Photo 4—The other units of the Customode.



Photo 5—A hybrid system for industrial use.



Illustration of one unitized-cabinet combination. Possible variations are almost unlimited.

Cover Feature

A Sonic Analyzer

An instrument which brings panoramic analysis to the audio spectrum



PANORAMIC analysis of radio-frequency signals became familiar during the last war. A receiver was electronically or mechanically tuned continuously over a given band of frequencies and its output fed into the vertical amplifier of a cathode-ray oscilloscope. A signal on any part of the band being covered would cause a pip to appear on the oscilloscope trace. By synchronizing the horizontal sweep of the oscilloscope with the tuning apparatus,

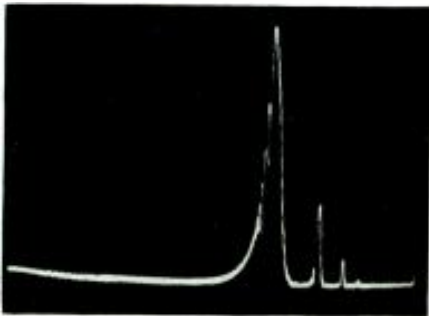

Fig. 1—A 1.5-kilocycle wave and harmonics.

the pip's position on the oscilloscope could be made to indicate its exact frequency.

Numerous panoramic analyzers were used by the military to cover the whole usable radio-frequency spectrum. Not only did they indicate the presence of enemy transmitters the instant they opened up, but also intercepted many distress messages. Due to makeshift equipment and inexperienced operators, these were often well off the regular distress bands on which constant watch was kept, and the panoramic analyzer was entirely responsible for many rescues which would never have been made without its help.

In times of peace, the panoramic analyzer is used by amateurs, who can survey a whole band continuously with it, and by commercial stations who can substitute one panoramic analyzer for a

number of receivers standing by on a single frequency.

They are also used for monitoring and designing industrial r.f. equipment, are used in laboratories for analyzing oscillations, pulsed signals, modulation characteristics of FM and AM systems, designing and maintaining mobile transmitters and receivers especially for FM, telemetering, radar studies, and by broadcast stations for observing characteristics of their transmitters continuously.

Panoramic audio analysis

To further increase the usefulness of the system, the manufacturers of the panoramic analyzer conceived the idea of extending the method to cover the *audio range*. The result was the *Panoramic Sonic Analyzer* shown on our front cover. This instrument sweeps the range from 40 to 20,000 cycles once per second, showing an audio signal of any frequency within the range as a pip on the horizontal base. Fig. 1 shows how it is used for analyzing an amplifier which is fed a signal at 1.5 kc. The second, third and fourth harmonics appear, and are measured on the screen at 4, 1.25 and 0.5% respectively. These measurements are on the *log* (left-hand) scale of the cathode-ray screen.

The value of such an instrument in checking audio amplifiers is obvious. Not only may harmonic distortion be instantly spotted and measured, but intermodulation distortion shows up immediately. It also has applications in

other audio measurements and particularly in vibration analysis.

In the Model AP-1 analyzer, a block diagram of which is shown in Fig. 2, the output of the equipment under test is fed into an a.f. amplifier. Its output, in turn, is swept by an oscillator which beats with any audio-frequency signals which appear to produce a *sum* frequency of 100 kc, which is applied to a very sharply-tuned 100-kc i.f. amplifier. The i.f. output is detected, amplified through a video amplifier and applied to the vertical plates of the cathode-ray tube, whose horizontal sweep is kept in synchronism with the local oscillator, thus permitting the face of the tube to be marked off horizontally in frequencies.

The frequency scale on the tube is logarithmic, and the sweeping oscillator also scans logarithmically. Since the ability to separate individual frequency components (the *resolution* of the instrument) depends on the relationship between the instantaneous rate of scan and the selectivity of the intermediate frequency stages, means is provided to vary the i.f. selectivity continuously. Selectivity is greater at the lower frequencies—where frequency components may be close together in terms of cycles—and decreases with increasing frequency. Perfect synchronization is obtained by having the selectivity controls, the local sweeping oscillator and the cathode-ray tube horizontal deflection controlled by the same sawtooth generator.

The balanced modulator shown direct-

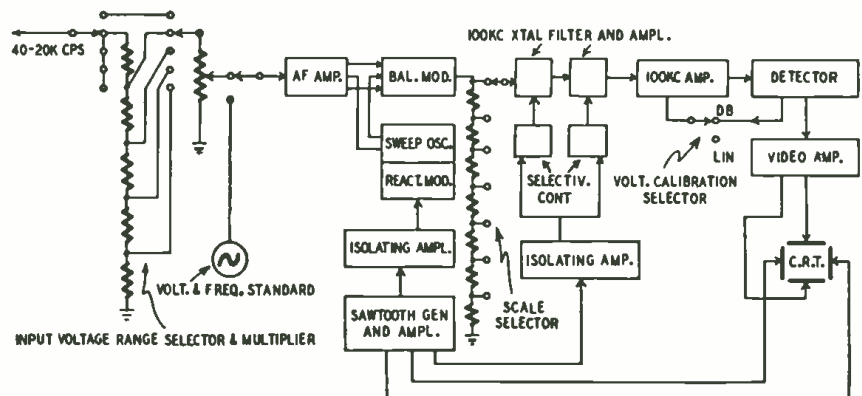
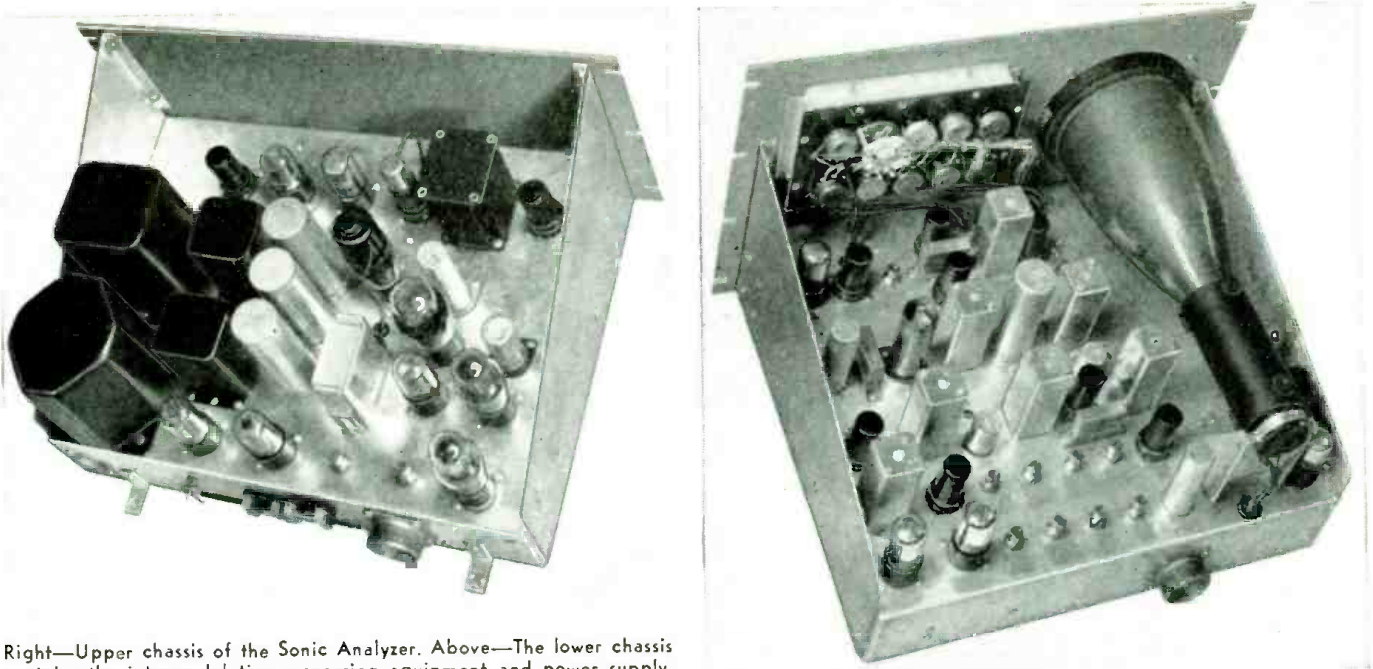

Fig. 2—Block diagram of the Panoramic Sonic Analyzer's main chassis (upper section in photo).



Right—Upper chassis of the Sonic Analyzer. Above—The lower chassis contains the intermodulation measuring equipment and power supply.

ly after the first a.f. amplifier eliminates spurious modulation products and keeps the local oscillator frequency out of the i.f.

Two voltage scales are provided on the cathode-ray tube—the left graduated in a two-decade log scale and the right graduated linearly. Input voltages are measured with the scale selector and input multiplier (third and sixth knobs from left, respectively). The scale selector has seven positions ranging from 0.5 to 50 millivolts, and the multiplier has five positions from $\times 1$ to $\times 10,000$. Thus a 250-volt signal would

produce a pip reaching to the 0.5 point on the cathode-ray tube linear scale, with the scale selector set at 50 mv and the multiplier at $\times 10,000$. (Full scale output would be 500 volts in this case.) Measurements as low as 50 microvolts are possible. Smaller measurements can be made by using a highly linear amplifier between source and analyzer.

Special equipment is provided in the lower chassis of the sonic analyzer for use in measuring intermodulation distortion. This consists roughly of amplifiers, attenuators and a demodulator to bring the input frequencies to a de-

sired level and switching equipment to measure each of the interacting frequencies.

While the instrument is intended mainly for measuring distortion in such types of audio equipment as amplifiers, radio receivers, hearing aids, etc., it may also be used to investigate rectifier hum, power system harmonics, high-frequency vibration and for Fourier analyses of square, rectangular, sawtooth and other types of waveforms. A variety of possible applications will immediately suggest themselves to the practical sound man.

NEW DEVICE MEASURES GAIN OF HEARING AIDS

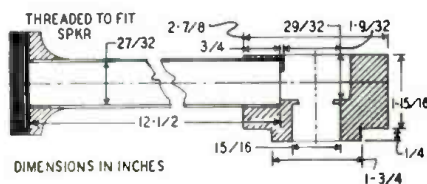
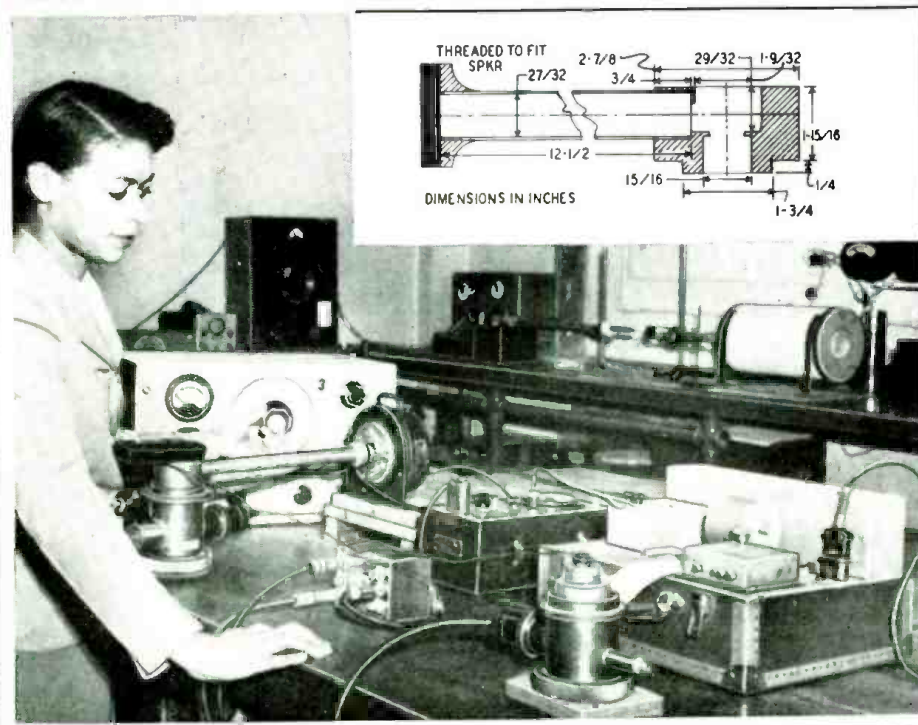

Bureau of Standards laboratory setup to determine the gain of hearing aids. An echoless room is usually used to compare the volume of sound picked up by the hearing-aid microphone with the volume supplied by the earphone after amplification. Method shown gives more precise measurements. The aid's microphone is fitted into one end of a sealed cavity to which sound is applied by a loudspeaker. The cavity, shown in inset, appears in the photo at lower left. The hearing aid's earphone is fitted to another sealed cavity. Sound pressure in each is measured and recorded for each frequency, on tape at right. The amount by which sound pressure in the earphone cavity exceeds that in the microphone cavity gives an indication of the hearing aid's net gain. Evaluation of the electrical gain of the amplifier is easily made with an ordinary meter, but no account is taken of the acoustic efficiency of the microphone and earphone. The new method of measurement gives information on over-all performance.

Radio Set and Service Review

Amplifier Co. of America Model 810



Model 810 Twin-Trax Magnetape Recorder.

TWO separate half-hour recordings or a single one-hour record may be made on a single 1,225-foot strip of Scotch recording tape with the new Twin-Trax Magnetape recorder, made by Amplifier Corporation of America, New York. The recorder is furnished either as a complete unit with case,

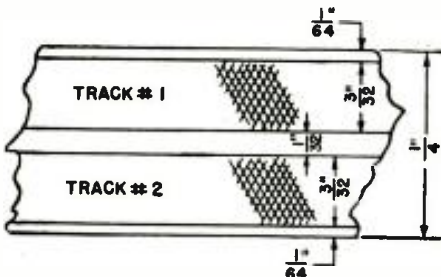

Fig. 1—How the two tracks are positioned.

5-watt, 10-tube, high-fidelity amplifier, and oval loudspeaker, or as a mechanism for which the purchaser may supply his own amplifier.

The tape-handling chassis is by far the most interesting portion of the recorder. It is the first of its kind on the market.

The tape is run through the machine in one direction and a half hour's material is recorded. Then the mechanism automatically reverses, and the tape runs in the other direction while a second half-hour recording is made. Probably the most important feature of the unit is the resulting economy. A standard half-hour reel of tape may be used for a full hour.

Fig. 1 shows how the tape is used twice. As the name of the recorder implies, the tape provides two recording tracks. The width of the recording on the standard $\frac{1}{4}$ -inch tape is $\frac{7}{64}$ inch with most recorders. In the Twin-Trax the tape utilizes two tracks, each $\frac{3}{32}$

inch wide, only $\frac{1}{64}$ inch less than the usual single track. There is $\frac{1}{32}$ inch spacing between the two.

No alteration is made to the tape. The two tracks are created by the positioning and construction of the record-playback head and the erase heads. These are shown in Fig. 2, a top view of the tape-handling chassis. One erase head is positioned at each side of center. The right-hand erase head is mounted slightly higher than the left one, so that it erases only the upper portion of the tape or track 1. The left erase head, set $\frac{1}{8}$ inch lower, takes care of track 2.

The single record-playback head at the center is used for both tracks. When the lever at right is placed in the FORWARD position, the tape runs from the right reel to the left. The record-playback head rises so as to magnetize (or be magnetized by) track 1 only. If the user has set the amplifier controls for recording, the lever also switches in the right-hand erase head, obliterating any previous recording on track 1.

When the lever is set at REVERSE the tape runs in the other direction and the record-playback head is lowered $\frac{1}{8}$ inch to coincide with track 2. When recording, the left erase head is energized to obliterate previous sounds on track 2.

Despite the close spacing of the tracks, tests show that, unless too high a recording level is used, program ma-

terial recorded on one track cannot be heard when the other track is played back. Due to the slightly reduced width of each track from the usual size, output in playback is about 1 db less than usual. Erasure of one track does not affect the other. Records made on the Twin-Trax (if made in one direction only) may be played back on any machine equipped to handle Scotch tape at $7\frac{1}{2}$ inches per second.

Excellent quality

The twin-track feature and the reduction in size of each track do not seem to affect tone quality. Frequency runs showed that response, from amplifier input to playback-channel output, varied no more than 3 db from 70 to 9,000 cycles. What is more important, listening tests made with a 12-inch, high-quality speaker showed a most satisfactory standard of performance. Using both high-fidelity FM channels and live performers, a large number of varied selections was recorded—popular and classical music, male and female speech, even dog barks. The latter were so lifelike that a dog in the room where the tapes were played back spent considerable energy trying to find the owner of the full-throated bay within the speaker cabinet. Though no distortion measurements were made, reproduction was extremely clean and noise level very low.

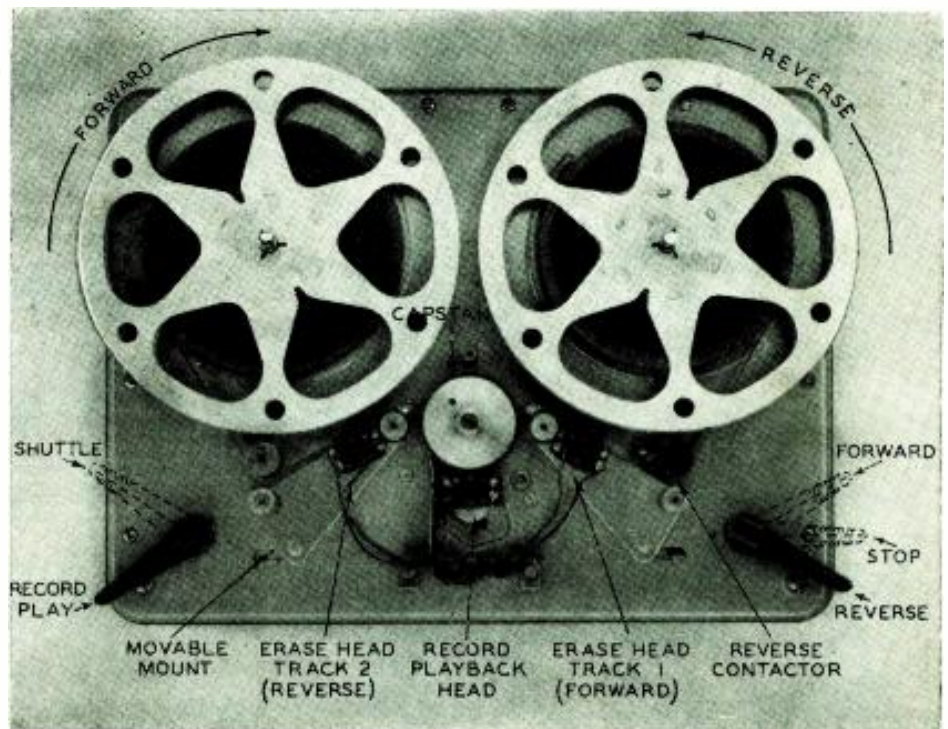

Fig. 2—Top view of the recording chassis, design of which permits very easy tape-threading.

Auditory fatigue, which is probably the best measure for small amounts of distortion, was not apparent even after several hours of listening.

The driving mechanism, consisting of a single motor and four rubber-tired drive wheels under the chassis, normally drives the capstan at a sufficiently constant speed to eliminate wow or noticeable variation in speed. The unit tested, however, did wow slightly toward the end of the forward run. This was traced to a small amount of oil which had dripped on the rubber tires of the drive wheels. Cleaning them with a small amount of carbon tetrachloride removed the wow. Normally, excessive lubricating oil is not used in the factory and a cup is provided to catch any leakage. The cup itself may possibly leak (as it evidently did in the tested unit) due to shipping and handling.

Some wow may also be caused if the tape reels are slightly low or high so that the tape does not wind evenly. A small, easily loosened setscrew beneath each drive shaft permits height adjustment.

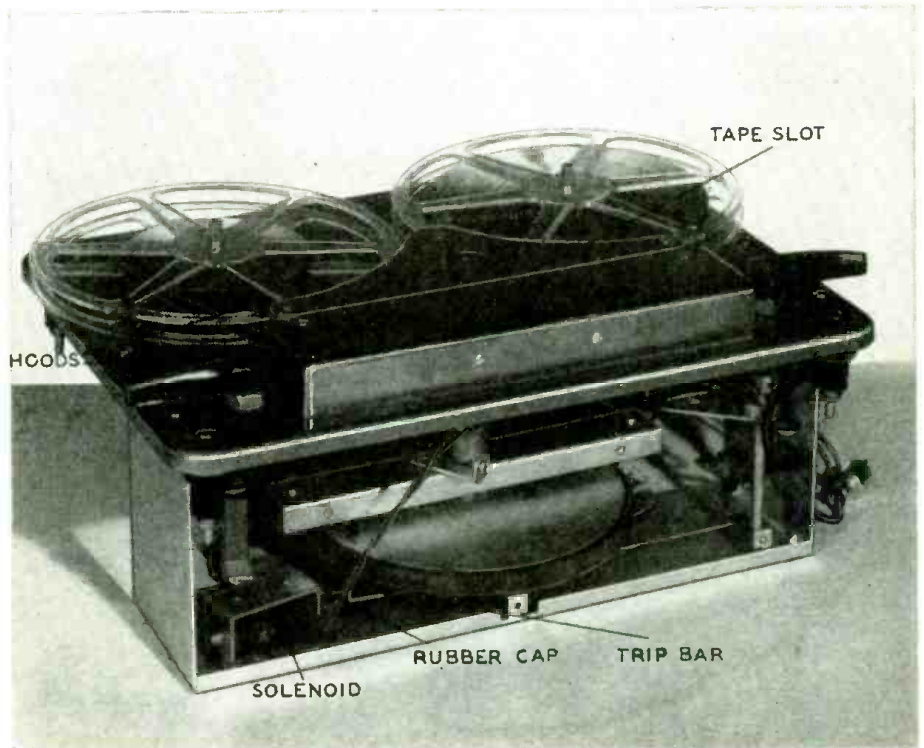

Fig. 3—Another view of the tape-handling mechanism, with protecting hoods in place.

Can record one hour

The twin-track feature may be used to record a continuous one-hour program. The reverse contactor, indicated in Fig. 2, is an insulated guide post

against which the tape rubs. Its center do not touch. Near the end of the tape is divided into two metal contacts which the user may paste a small strip of con-

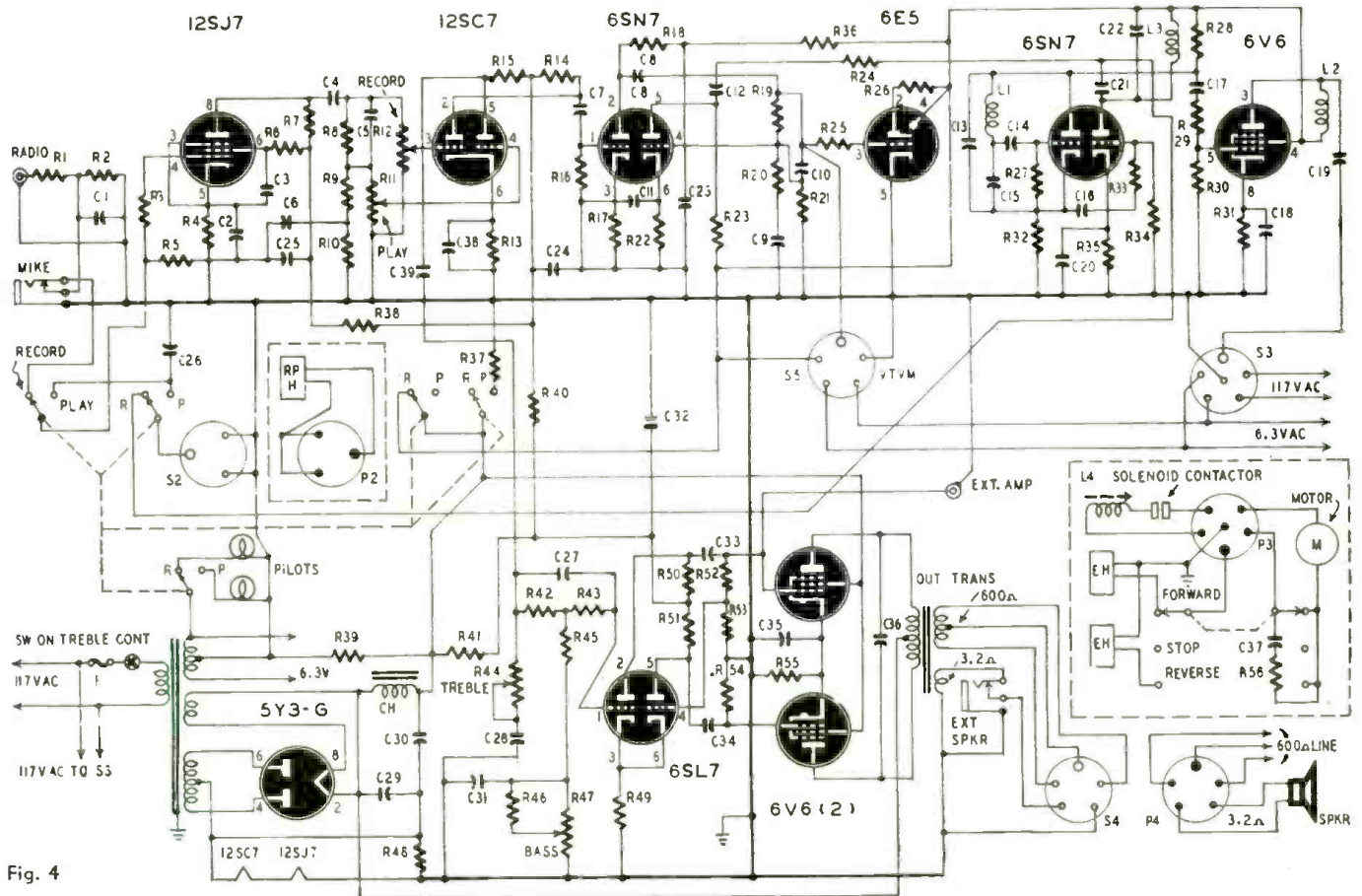

Fig. 4

- R1-470K, R2-20K, R3-40K, R4-1.5K, R5-1MEG, R6-1MEG, R7-250K, R8-270K, R9-40K, R10-1MEG, R11-500K, R12-500K, R13-1K, R14-100K, R15-250K, R16-250K, R17-1K, R18-50K, R19-270K, R20-10K, R21-1MEG, R22-2K, R23-50K, R24-50K, R25-500K, R26-1MEG, R27-100K, R28-27K, R29-100K, R30-250K, R31-250/10W, R32-27K, R33-100K, R34-50K, R35-1K, R36-10K, R37-7.5K/20W, R38-25K, R39-25K/20W, R40-10K, R41-10K, R42-270K, R43-270K, R44-1MEG, R45-20K, R46-10K, R47-1MEG, R48-5K, R49-1K, R50-100K, R51-100K, R52-500K, R53-25K, R54-500K, R55-200/10W, R56-2.5
- C1-.0005, C2-10/450V, C3-.1, C4-.1, C5-.00025, C6-.002, C7-.1, C8-.1, C9-.01, C10-.001, C11-.1, C12-.25, C13-.001, C14-.01, C15-.01, C16-.001, C17-.001, C18-.1, C19-.001, C20-.05, C21-.0005, C22-.0001, C23-10/450V, C24-10/450V, C25-10/450V, C26-VALUE DETERMINED BY HEAD, C27-.0002, C28-.002, C29-10/450V, C30-10/450V, C31-.006, C32-10/450V, C33-.1, C34-.1, C35-10/450V, C36-.00025, C37-.5, C38-50/25V, C39-.1, ALL CONDS 400V UNLESS OTHERWISE NOTED
- RPH-RECORD PLAYBACK HEAD E H-ERASE HEAD

ducting tape—Scotch cellulose gummed tape backed with metal foil. When the foil shorts the contacts, a solenoid is actuated. The solenoid is shown at the lower left in Fig. 3. Its plunger travels to the right, pushing a long metal bar which trips the forward-reverse lever into REVERSE. The tape immediately changes direction and track 2 comes into use. Reversal time is about 1/5 second, and disturbance to the program is slight.

Shuttling difficulties

During the tests, the solenoid sometimes failed to throw the lever into REVERSE, leaving it, instead, at STOP. The maker stated that this was due to malpositioning of the small rubber cap on the right end of the solenoid plunger, and that, if the trouble seems likely to recur in production models, a firmer mounting for the cap will be devised.

The shuttling lever at the left in Fig. 2 is used for high-speed rewind and for threading the tape. All three heads are on movable mounts. When the lever is placed in the SHUTTLE position, the heads snap back out of the way (downward in the picture). The tape is then put in place merely by dropping it into the slot between the hoods (Fig. 3), which places it automatically between the heads and the capstan and guides. The lever is then placed in the RECORD PLAY position. This pushes the erase heads against the tape and locks it tightly between the record-playback head and the capstan, so that tape speed will be controlled only by the capstan. The lack of any need for threading tape

around various heads and guides simplifies operation considerably.

When the left lever is placed at SHUTTLE and the right lever shifted into FORWARD or REVERSE, the capstan no longer controls tape speed. Rate of travel in either direction is, therefore, much increased—four times, in fact. Although twin-track operation normally leaves the tape rewound at the end of a one-hour session, the high shuttling speed is very useful for rewinding when less than an hour has been recorded or for skipping a portion of the tape to play back only selected parts. A complete rewind at the shuttling speed takes 7½ minutes.

The operator should not shift from SHUTTLE to RECORD PLAY while the tape is running at high speed. It is perfectly permissible, however, to shift from the low to the high speed without stopping the motor.

The amplifier

The complete recorder is shown in the photo at the head of the article. The photo is that of a pre-production model, and the panel lettering has been changed slightly.

The schematic diagram appears in Fig. 4. Except for the 12SJ7 preamplifier (note d.c. filament heating of this and the 12SC7), two separate channels are provided for recording and playback.

In recording, the microphone or tuner signal is amplified by the 12SJ7, the left half (on the diagram) of the 12SC7, and the left triode of the 6SN7.

It is then equalized by a fixed network, C9 and 10 and R19, 20, and 21 (manufacturer's part numbers). The output of the second triode of the 6SN7 feeds the head. A 6E5 electron-ray tube mounted on the control panel (not shown in the early model) is used as a recording-level monitor. For professional users S5 is provided for connection to a vacuum-tube VU meter. The socket furnishes all necessary power.

The supersonic bias and erase signal (approximately 50 kc) is generated by a 6SN7 and a 6V6. Erase voltage is fed to the erase heads through a plug and socket, P3 and S3, respectively. Bias is superimposed on the audio signal by simple capacitive coupling to the head through C21. In the diagram all components which are parts of the tape-handling chassis are enclosed in dashed boxes.

The playback channel has a gain of about 120 db. The high gain is the principal reason for using d.c. on the first two tube heaters. After passing through the right half of the 12SC7, the signal is fed to the 6V6 output tubes through a standard 6SL7 phase inverter. Output is 5 watts to a 6 x 9-inch oval speaker.

As the diagram shows, connections are provided for an external 600-ohm speaker. No 600-ohm wires are attached to P4, so the owner must install them. A phone jack allows plugging in an external 4-ohm PM speaker.

Equalization system

Both fixed and variable equalizers are incorporated in the playback channel. Fixed components are C5, 6, and 26, and R8, 9, 10, C27, 28, and 31, and R42, 43, and 45 are parts of the variable equalizers. The controls are R44 (treble) and R47 (bass). The positions of these controls for flat output are marked on the front panel with red dots.

A connector is furnished for feeding the output of the playback channel to an external amplifier. This is useful for dubbing tape recordings onto discs or for feeding PA systems. A maximum of about 3 volts is available.

To avoid increasing the over-all height of the recorder, the amplifier, shown in Fig. 5, is mounted under the tape chassis with tubes on the rear apron. This also keeps the tubes cooler and makes replacement easy.

Buyers of the tape-handling chassis are furnished with an instruction book which describes the necessary amplifying equipment and shows how to connect the heads to existing amplifiers, as well as giving the necessary instructions and cautions on the actual manipulation of the mechanism.

The tape-handling mechanism is likely to become very popular with experimenters and sound men who already have elaborate amplifying equipment. There is tremendous enthusiasm for magnetic—and especially tape—recording, but the difficulty of building the precision recording and playback head has deterred most serious workers from constructing recorders of their own.

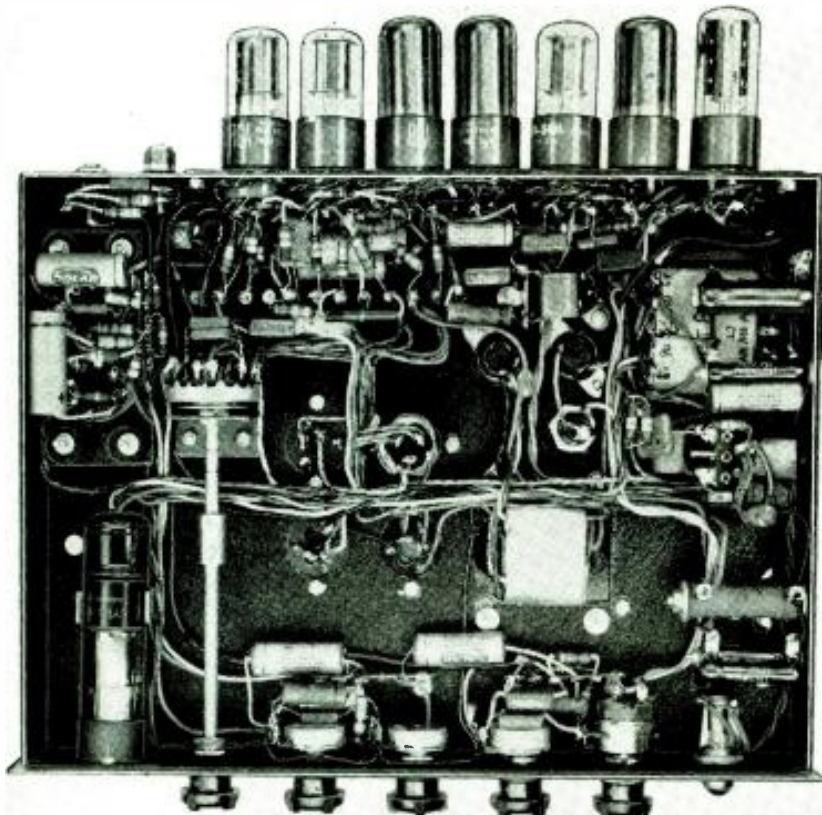
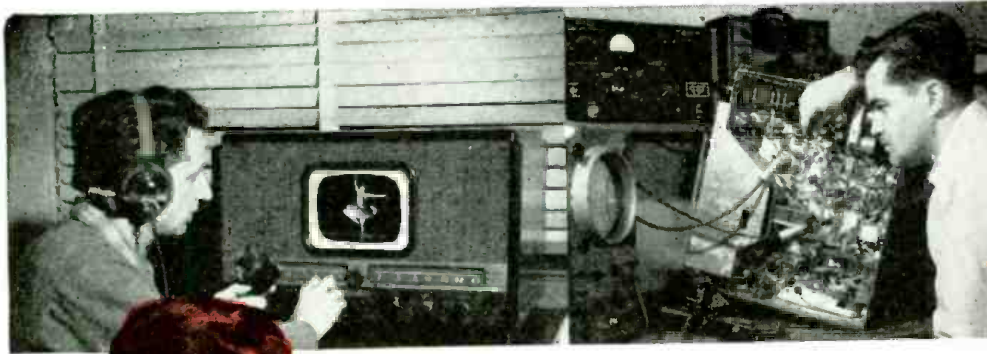

Fig. 5—The amplifier is specially constructed to fit under the tape-pulling chassis.



**DON'T BE
A "PRE-WAR"
MODEL!**



**MAKE MORE MONEY
— ENJOY SECURITY
with CREI'S Brand-New
100% Practical
"On-the-Job"
Course**

"Television and FM Servicing"

For Every Serviceman Who Realizes He Must Keep Pace — or Be Left Behind

Don't Put it Off! Get Going Now With this "Down-to-Earth" Course that Will Equip You to Forge Ahead in the Servicing Field

The next twelve months will produce some of the greatest opportunities that have ever been offered to alert men in the Servicing Field.

It is the year for you to make the big decision. Either you are going to catch up with the new developments in the industry, or you are going to be passed by.

We think your opportunities are so great, that over a two-year period we have been developing this brand-new, practical course. It is written for *today's* servicemen to meet *today's* problems and opportunities.

CREI knows what you need, and every effort has been made to keep this course practical and to the point. If you are now engaged in servicing work, you will be able to understand and apply each lesson. This course has been reviewed and checked by qualified service experts who know what *you must know* to get ahead in this booming field.

Every lesson can be helpful in your daily work—you will

soon have the technical knowledge necessary to handle all types of good paying Television and FM servicing business.

It costs you nothing but a few minutes time to get the complete details of what we offer and what it can do for you.

CREI EQUIPS YOU TO INSTALL AND SERVICE ALL TYPES OF TELEVISION AND FM RECEIVERS

Now . . . with the help of this new CREI streamlined Service course you can move ahead to unlimited opportunities in your chosen field. CREI has again taken the lead by offering a course so entirely new that for the first time in our twenty-one year history we can offer a down-to-earth course of training for servicemen. In offering this course at a popular price, CREI is enabling thousands

of the "top third" now engaged in service work to enter the ultimate profitable field of television and FM installation and service.

This can be your big year! Don't waste another day. CREI has the answer to your future security in this new servicing course. Write today for complete information. The cost is *popular*. The terms are *easy*. The information is *free*. Write today.

**Radio Service Division of
CAPITOL RADIO
ENGINEERING INSTITUTE**

An Accredited Technical Institute

Dept. 5108, 16th & Park Rd., N.W., Wash. 10, D.C.

Branch Offices: New York (7) 170 Broadway - San Francisco (2) 760 Market St.

OCTOBER, 1948

**MAIL
TODAY**

CAPITOL RADIO ENGINEERING INSTITUTE
16th & Park Road, N. W., Dept. 5108, Washington 10, D. C.

Gentlemen:

Please send me complete details of your new home study course in Television and FM Servicing. I am attaching a brief resume of my experience, education and present position.

NAME _____

STREET _____

CITY _____ ZONE _____ STATE _____

I AM ENTITLED TO TRAINING UNDER G. I. BILL.

Frequency Test Records

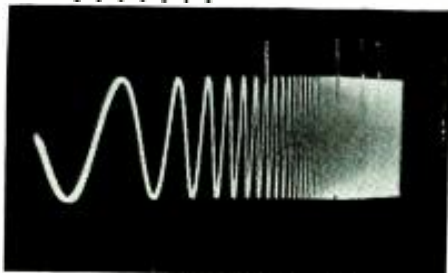

Output of pickup from Clarkstan sweep record shows flat response (above) and dip (below).

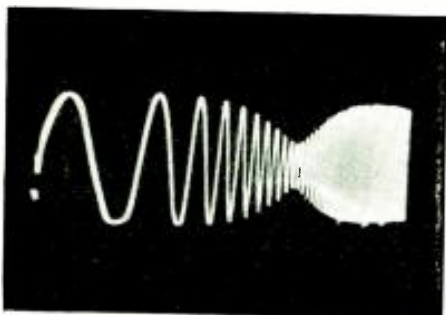

HOW good is your phonograph pickup? How well does it perform? How correct is the equalizer you have bought or built to go with it? You can find the answers to these questions with very little trouble and expense by using standard frequency records. At least one of these discs should be in the record library of every audio enthusiast. Radio servicemen who are called on to install and repair changers and hi-fi phono systems are missing a good bet, too, if they don't keep a tone record in the shop.

Phonograph pickups are not easy to calibrate with ordinary equipment. To check an amplifier, all you have to do is connect an audio oscillator to the input and a voltmeter to the output and start twisting dials. But you can't check pickups without a frequency record unless you use expensive custom-built laboratory equipment.

Five firms make the test discs which are most easily available in this country. Each company makes several different records, each designed for a special purpose. To choose the proper one for your own needs, note the description of each record carefully and check the information against your own problems.

Columbia frequency records

Probably two of the most often used tone records are the Columbia 10003-M and 10004-M. The curve of the 10004-M is the same as curve 1 in Fig. 1. The curve of the 10003-M is similar, except that the turnover is moved down to 300 cycles. Both these records begin with a 1,000-cycle tone. This is useful for set-

Tone discs are an indispensable tool for the audio enthusiast and the serviceman. Pickups cannot be equalized without them, and other uses are many

By **RICHARD H. DORF**

ting the amplifier gain control to some convenient reference level on the meter connected to its output. In all cases, the amplifier used should be flat and the speaker should be replaced with a dummy load resistor. You can bridge headphones across the resistor to listen to the record.

After the 1,000-cycle tone, frequencies from 10,000 down to 50 cycles are given. At each of the selected frequencies (there are 18 of them) a voice identifies the tone to be given, then the tone is recorded for several seconds. Jotting down the output-meter readings gives the performance of the pickup-amplifier combination. If the amplifier is flat, the readings will give the curve of the pickup.

Because of the age of the masters from which these Columbia records are pressed, the 10003-M is not flat at the high frequencies. Tests of several recent samples show that response begins to drop off at about 2,000 cycles and is down 9 db at 10 kc. About the same effect is present with the 10004-M. Columbia is understood to be preparing a new set of test discs, including at least one which can be used to calibrate pickups for the new Microgroove records. Most discs cannot be used for this purpose because the grooves are too wide for the 1-mil-radius needle.

RCA Victor records

RCA makes a number of test records, some of which contain no modulation. These have lead-in grooves, a few normal grooves, and an eccentric lead-out groove. They are used for testing the action of record-changers and juke boxes. There are also records with a few odd-frequency tones, used for special applications.

Probably the most useful RCA record at present is the 12-5-5. This disc contains a continuously varying tone, beginning with 10,000 cycles at the outside and ending with 30 cycles on the inside. Buzzer signals are inserted at a number of points to mark the frequencies. The disc is flat above 800 cycles (except for a slight dip at about 8,000). The crossover frequency is 500 cycles. Like most records, the bend in the curve is not as sharp as in Fig. 1, but more gradual.

On this record, the change begins to take place at 800 cycles and is 1½ db down at 500 cycles. Below 500 cycles the curve drops at 6 db per octave.

Another RCA record, the 12-5-25, will be very useful for owners of a 33 1/3-r.p.m. turntable. Made of Vinylite, it begins with a combined 400- and 4,000-cycle tone for intermodulation tests. Constant-frequency tones are then given from 12,000 to 30 cycles.

No information is available on the condition of present pressings of the RCA discs. Since the 12-5-25 is a fairly new recording, it is probably in good condition.

London Gramophone

An excellent set of discs is made by the London Gramophone Corporation. The album is No. LA-32. Three records are included plus the best stroboscope we have seen. The stroboscope is calibrated for 78 and 33 1/3 r.p.m. and for 50 and 60 cycles. There are only two bands on each side. The disc is only two inches in diameter and the stroboscope bands are in white against a black background.

The first record has a constantly varying tone from 14,000 to 10 cycles, recorded with the same characteristic as is employed on standard London records and Decca ffrr discs. A playback system can be equalized perfectly for the high-quality British discs with this

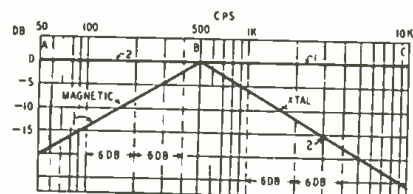

Fig. 1—Curves show how pickup types differ.

record. All that is necessary is to play the frequency record, adjusting equalization until the amplifier shows flat output throughout the range. American manufacturers might take a hint from the British, both on standardization of the characteristic and on issuing frequency records for it. This British standard is shown in Fig. 2.

The second disc has the same low-fre-

MONEY BACK GUARANTEE — We believe units offered for sale by mail order should be sold only on a "Money-Back-If-Not-Satisfied" basis. We carefully check the design, calibration and value of all items advertised by us and unhesitatingly offer all merchandise subject to a return for credit or refund. You, the customer, are the sole judge as to value of the item or items you have purchased.

THE NEW MODEL 670

SUPER METER



SUPER METER, A Combination VOLT - OHM - MILLIAMMETER plus CAPACITY REACTANCE, INDUCTANCE, and DECIBEL MEASUREMENTS.

D.C. VOLTS: 0 to 7.5/15/75/150/750/1500 7500. **A.C. VOLTS:** 0 to 15/30/150 300/1500 3000. **OUTPUT VOLTS:** 0 to 15/30/150 300/1500 3000. **D.C. CURRENT:** 0 to 1.5/15/150 ma.; 0 to 1.5 Amperes. **RESISTANCE:** 0 to 500/100,000 ohms. 0 to 10 Megohms. **CAPACITY:** .001 to .2 Mfd., .1 to 1 Mfd. (Quality test for electrolytics.) **REACTANCE:** 700 to 27,000 Ohms; 13,000 Ohms to 3 Megohms. **INDUCTANCE:** 1.75 to 70 Henries; 35 to 8,000 Henries. **DECIBELS:** -10 to +18, +10 to +38, +30 to +58.

The model 670 comes housed in a rugged, crackle-finished steel cabinet complete with test leads and operating instructions. Size 5 1/2" x 7 1/2" x 3". **\$2840 NET**

The New Model 450

TUBE TESTER

Speedy operation—assured by the newly designed rotary selector switch which replaces the usual snap, toggle, or lever action switches.



SPECIFICATIONS

*Tests all tubes up to 117 volts. *Tests shorts and leakage up to 3 Megohms in all tubes. *Tests both plates in rectifiers. *New type line voltage adjuster. *Tests individual sections such as diodes, triodes, pentodes, etc., in multi-purpose tubes. *Noise Test detects microphone tubes or noise due to faulty elements and loose internal connections. *Uses a 4 1/2" square rugged meter. *Works on 90 to 125 volts 60 cycles A.C.

EXTRA SERVICE—May be used as an extremely sensitive condenser leakage checker. A relaxation type oscillator incorporated in this model will detect leakages even when the frequency is one per minute. **\$3950 NET**

The Model S-35 — a POWERFUL

REFLEX PROJECTOR

COMPLETE WITH WESTERN ELECTRIC BUILT-IN DRIVER UNIT

CONSERVATIVELY RATED AT 35 WATTS—WILL EASILY HANDLE UP TO 55 WATTS WITHOUT BLASTING

Heavy gauge aluminum in the main trumpet section completely eliminates blasting and blaring. New plastic diaphragm overcomes the resonant peaks of the old type; also it is absolutely impervious to atmospheric changes whereas the old type was subject to atmospheric corrosion. Complete unit unconditionally guaranteed for one year.



Specifications

POWER (CONSERVATIVE) — 35 WATTS; **AIR COLUMN**—3 1/2 FT.; **DISPERSION**—80°; **POWER (PEAK)** —55 WATTS; **BELL DIAMETER** —15"; **IMPEDANCE**—8 ohms; **FREQUENCY RANGE**—130 to 5000 C.P.S. **PROJECTION** — 1/2 mile; **FINISH** — Attractive two tone crystalline. The Model S-35 Comes Complete with Built-in Driver Unit, ONLY **\$2850 NET**

The New Model 770 — An Accurate Pocket-Size

VOLT-OHM MILLIAMMETER



(Sensitivity: 1000 ohms per volt)
Features: Compact—measures 3 1/4" x 5 7/8" x 2 1/4". Uses latest design 2 1/2" accurate 1 Mil. D'Arsonval type meter. Same zero adjustment holds for both resistance ranges. It is not necessary to readjust when switching from one resistance range to another. This is an important time-saving feature never before included in a V.O.M. in this price range. Housed in round-cornered, molded case. Beautiful black etched panel. Depressed letters filled with permanent white, insures long-life even with constant use.
Specifications: 6 **A.C. VOLTAGE RANGES:** 0 15/30/150/300/1500/3000 volts. 6 **D.C. VOLTAGE RANGES:** 0-7 1/2/15/75/150 750/1500 volts. 4 **D.C. CURRENT RANGES:** 0-1 1/2/15/150 Ma. 0-1 1/2 Amperes. 2 **RESISTANCE RANGES:** 0-500 ohms. 0-1 Megohm.
The Model 770 comes complete with self-contained batteries, test leads and all operating instructions. **\$1390 NET**

THE NEW MODEL 777

20,000 OHMS PER VOLT!! TUBE & SET TESTER

Tube Tester Specifications:
★ Tests all tubes including New Miniatures, etc. Also Pilot Lights.
★ Tests by the well-established emission method for tube quality, directly read on the scale of the meter. ★ New type line voltage.



V.O.M. Specifications:
* **D.C. VOLTS:** (at 20,000 Ohms Per Volt), 0 to 7.5/15 75/150/750/1,500 Volts.

* **A.C. VOLTS:** (At 10,000 Ohms Per Volt), 0 to 15/30/150 300/1,500 3,000 Volts.

* **D.C. CURRENT:** 0 to 1.5/15/150 Ma. 0 to 1.5 Amperes.
* **RESISTANCE:** 0 to 5,000/50,000/500,000 Ohms. 0 to 50 Megohms.

Model 777 operates on 90-120 volts 60 cycles A.C. Housed in beautiful hand-rubbed cabinet. Complete with test leads, tubes, charts and detailed operating instructions. Size 13" x 12 1/2" x 6". **\$5995 NET**

The Model 88 — A COMBINATION

SIGNAL GENERATOR AND SIGNAL TRACER



Signal Generator Specifications:
*Frequency Range: 150 Kilocycles to 50 Megacycles. *The R.F. Signal Frequency is kept completely constant at all output levels. *Modulation is accomplished by Grid-blocking action which is equally effective for alignment of amplitude and frequency modulation as well as for television receivers. *R.F. obtainable separately or modulated by the Audio Frequency.

Signal Tracer Specifications:
*Uses the new Sylvania 1N21 Germanium crystal diode which combined with a resistance-capacity network provides a frequency range of 300 cycles to 50 Megacycles. **\$2885 NET**

The Model 88 comes complete with all test leads and operating instructions. ONLY

20% DEPOSIT REQUIRED ON ALL C.O.D. ORDERS

GENERAL ELECTRONIC DISTRIBUTING CO. DEPT. RC-10 98 PARK PLACE, NEW YORK 7, N. Y.

quency characteristic (turnover at 300 cycles) but the high end is flat. Again the highest tone recorded is 14,000 cycles, which is higher than anything on American test records. Tests made with the London frequency album, using an equalized G-E pickup, showed that the inclusion of 14,000 cycles was no mere gesture. Both the optical pattern and the pickup tests showed that the 14,000-cycle tone was not only present, but actually was slightly higher in level than the rest of the treble band.

The third disc has the same curve as the second but instead of a continuous variation in frequency, a number of constant tones are used. The same range is covered but the lowest frequency is 30 cycles instead of 10.

The London records are pressed in the same smooth material (with high shellac content and little abrasive) as London musical discs. The surface noise is so low that the level of even the highest-frequency tones can easily be judged on an output meter. The album is an outstanding one in every respect. It is too bad that there is not one disc with a 500-cycle turnover (for equalizing for American records) but the higher-frequency sections of at least two of the discs are eminently suited for equalizing a system for any purpose.

Universal D61B

The only disc, as far as we know, made at present by the Universal Microphone Company is the D61B. This is evidently intended primarily for the serviceman, though at least the high-frequency section is useful to anyone.

The D61B is pressed in a very quiet plastic, probably Vinylite. It is comparatively new, so can be expected to be in good condition. The sample tested shows (both light pattern and pickup tests) some very slight dropoff at the high frequencies. This is not sufficient even to be measurable in many cases. The frequencies above a 500-cycle turnover are recorded flat. The tone is a continuously varying one, with voice announcements at each 1,000-cycle mark. Top tone is 10 kc.

The low-frequency section of the D61B has been recorded in 2 bands on the usual constant-amplitude basis. The first band, 50 to 200 cycles, was made at a level 7 db lower than the next, which is 200 to 500 cycles. This, in turn, is 7 db lower in level than the rest of the disc. Just why this was done is not known. The literature accompanying the record gives the output voltages of 14 American, Astatic, and Shure crystal pickups at 400 and 1,000 cycles. This enables the serviceman to spot a bad one without too much trouble.

Clarkstan sweep-frequency

One of the most interesting test records made is the Clarkstan Sweep-Frequency Transcription, available for both 33 1/3 and 78 r.p.m. turntables. It has a tone which varies between 60 and 10,000 cycles at a rate of 20 times per second. The effect is very similar to that obtained in visual receiver alignment

when a frequency-modulated oscillator is used. The amplifier output cannot be measured directly but must be fed to the vertical plates of an oscilloscope. The pattern, for a flat pickup and amplifier, is similar to that at the head of this article. The lower figure shows the pattern when there is a dip at about 5,000 cycles and a peak at 3,000. The entire frequency range can be observed at once and the effect of any adjustments in the playback system can be seen without necessity for making a laborious run through the whole band. Marker pulses are placed at 1,000, 3,000, 5,000, 7,000

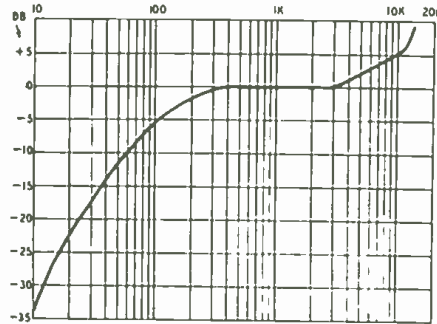

Fig. 2—British discs are recorded this way.

and 10,000 cycles so that each part of the pattern may readily be identified.

The patterns show not only frequency response of the system, but also harmonic distortion and transient response.

Using the discs

In using a frequency record (and in selecting one, too) the technician must have a good idea of the results he wants to get. The desired result, the equalized frequency curve—will be the same, no matter what type of pickup is used, though the equalizer circuits used to obtain them will vary.

Almost always, the bass band (up to about 1,000 cycles) should be adjusted for flat output. The trick here is to choose a record with the proper turnover frequency. For playing most American-made discs choose one with a 500-cycle turnover; for foreign ones a 300-cycle one is more suitable. For the British high-fidelity records the first record of the London frequency album is best. All that need be done is to equalize for flat response over the entire range.

The high-frequency band is something of a problem. Some high-frequency pre-emphasis is used in all musical records. The exact amount is not standardized. However, probably the best compromise is to adjust for the NAB curve, which slopes downward, beginning at about 1,000 cycles, to -16 db at 10 kc. American makers do not lay claim to any frequencies higher than this.

Since the best records to use for this purpose are recorded with a flat high end, the proper equalization will have been obtained when the pickup output is flat below 1,000 cycles and has the indicated dropoff above 1,000.

Frequency records are valuable to sound men who do not own an audio test generator. If the records, particularly those with a series of constant tones,

are played with a good pickup or one equalized to give flat output over the range, the recorded tones can be used in place of the test oscillator.

For testing amplifiers it is possible to use a pickup which does not have a flat response, but some method of controlling the amplitude of the tone will have to be used. This is not always a good idea, since if the pickup is very deficient in the high range, so much pre-amplification may have to be used that noise will spoil the measurements.

Servicemen who find themselves confronted with defective changers will find an investment in one of the special test records well worth while. Some of these, mentioned earlier, are available from RCA. They will test the entire operation of the changer mechanism in a few seconds.

Space does not permit a discussion here of the underlying principles of making records. For that reason, the reader may wonder why the low-frequency section (below turnover) is recorded at lower level than the rest of the range. That this is true is illustrated by the "Christmas-tree" light pattern photograph. The width of the light bands seen when a record is held so that a single light source is reflected from it indicates the volume level of each of the tones recorded. A full explanation of this appears in the writer's book, *Practical Disc Recording* (Radcraft Publications) now just off the press.

One last word of consolation for those who have had unhappy results with frequency records. Aging of the masters and wear of any particular pressing may make results erratic. If your pickup response seems to have small peaks and valleys in the range, especially if the highs roll off, don't throw away the cartridge. Most laboratories roll their own tone discs (when they use them at all) indicating that the best audio engineers are reluctant to accept findings based on pressings as entirely conclusive. However, a good collection of test records will give very usable results, especially if the discs are used to check each other. The average of the curves given by two or more similar discs will prove to be accurate enough for almost anyone.

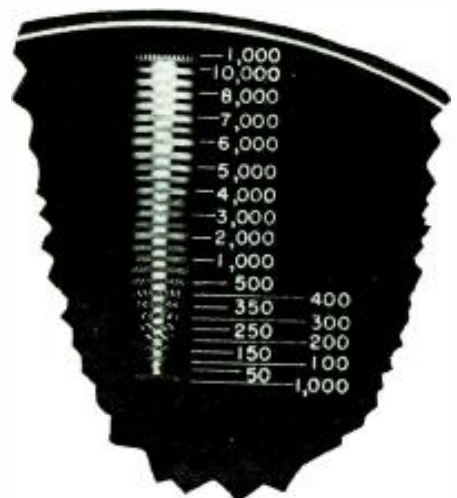

Fig. 3—Velocity indicated by light pattern.



LAFAYETTE-CONCORD

ELECTRO NEWS

29 Years of Service—500,000 Satisfied Customers

HUGE MERGER PAYING OFF FOR RADIO MEN!

Here's aspirin for those high price headaches. Bargains are still around for smart shoppers. Take a look at a few samples we've taken from our stocks:

SPECIAL BUY!

VACUUM TUBE VOLTMETER KIT



4 1/2" square meter. 0-500 microamps dc. DC input resistance of circuit, 11 megohms. AC input resistance, 6.5 megohms. Ranges: 1 to 1000 megohms in 5 ranges. AC and DC voltage on linear scales. 0-3; 30; 100; 300; 1,000 volts. Tubes: 1-6SN7 bridge type voltmeter circuit. 1-6H6 balanced linear diode as rectifier. Precision resistors, 1% accuracy. Output meter scale is calibrated for 600 ohm circuit and based on reference level of 1 mw. Rectifier power supply. 6" x 9" x 5". Kit complete with case, tubes, battery and instructions ready for assembly. 110 V., 50-80 cycles, AC.

No. 24540R.....**'29.95**

PLAY RECORDS BY REMOTE CONTROL THRU RADIO



Supplies sufficient power to play records through radio receiver at full volume in other rooms, without wired connections. Oscillator frequency variable between 1350 to 1700 KC by means of screw driver adjustment of trimming condenser. Small enough, 4" x 4" x 2" metal case, to go into any standard record player. No. 24531R, complete kit, less tube.....

No. 117N7-GT tube.....**'3.49**
No. 117N7-GT tube.....**'12.34**

MAGIC RADIO-MIKE

Without wires, lets you broadcast through your own radio. Simply turn on radio and tune to any clear channel between 1250 and 1700 KC, talk into the mike, and you'll hear through your own radio up to 75 feet away. For home, office, restaurants, nurseries. Uses 45 V. miniature "B" battery and flashlight cell. No. 22548R, complete with tube & battery.....



BEST BUY! 12" SPEAKER

Alnico V Permanent Magnet Dynamic Speaker. 1" voice coil with 6-8 ohm impedance. 14-18W. capacity. Dust proof construction. Ideal for fine FM reception, public address work, etc. An unbeatable value, limited quantity, so rush your order!



No. 5B7010R.....**'5.95**

RUGGED SELENIUM RECTIFIER

May be used to replace 117Z6, 117Z3, OY4, and other rectifier tubes and socket in AC-DC battery type portable radios, intercoms, etc. Peak inverse V. 380 V.; 100 milliamps max. 1 1/4" square x 1 1/16" high. Replaces both tube and socket. These miniature rectifiers are extremely rugged and long lasting. Order a half dozen.



No. 10560R.....**'75**



STROMBERG-CARLSON DYNATENNA FM DIPOLE ANTENNA

Covers all FM bands. Heavy mounting bracket with swivel base permits antenna to be turned for best reception from any direction. Slide-in trombone type arms are calibrated and marked in megacycles. Arms and mast of light, seamless, heat-treated aluminum tubing. Easy to handle, yet tough enough to withstand winds, ice, snow. Complete with hardware, six feet of 300 ohm low-loss twin lead-in wire.

5B9578R - Each, singly.....**'4.95**
Each, in lots of 3.....**'14.45**

Just 30 days ago we broke the news about the sensational Lafayette-Concord merger. And ever since, cheers have been pouring in from value-wise radio men all over the world!

New Versatile Hi-Fi Amplifier!



NEW YORK: Lafayette-Concord engineer, Frank W2AMJ Lester announces a new amazing versatile amplifier. It delivers 10 watts at less than 5% distortion over the entire range of 40 to 15,000 c. Variable bass and treble controls. Separate high

gain channel for G. E. pickup or mike, and low gain channel for tuner. The amplifier is also designed for use with the Webster 79 wire recorder foundation unit. A complete package is being made up which includes the amplifier, Webster foundation unit and a high frequency roll-off control. The roll-off control with 6 positions for the G.E. variable reluctance or Pickering cartridge permits switching from mike to pickup. Write for info on how to adapt this equipment to your needs.

These fellows like the deal because it means even better service, even lower prices — and they know it! Lafayette-Concord is now the largest radio supply organization in the world, bar none. Does that put any butter on your bread? Mister, just ask your wife why she likes to shop at the A & P, at Woolworth's, at R. H. Macy, and she'll tell you. It pays to do business with the top organization. You get what you want. You get it right away. You get it for less. And you're sure of a square deal! Check these 5 important points: 1. GREATER VALUE; 2. COMPLETE STOCKS; 3. FASTEST DELIVERY; 4. ENGINEERING HELP; and 5. OLD TIME RELIABILITY. You get more than a full measure of each when you head your orders to Lafayette-Concord.

HAVE YOU SENT FOR YOURS?



NEWS ON THE TV FRONT

At the start of 1948 there were 17 TV stations on the air. Today there are 31 and many new ones are scheduled to open fast, right across the country. A few of these are: Birmingham, Ala.; Phoenix, Ariz.; San Diego, Calif.; Ames, Iowa; Peoria, Ill.; New Orleans, La.; Lansing, Mich.; Syracuse, N. Y.; Nashville, Tenn.; Dallas, Tex.; Atlanta, Ga.; Jacksonville, Fla.; Indianapolis, Ind.; Portland, Ore.; Salt Lake City, Utah; Omaha, Neb.; and Louisville, Ky.

Here's the opportunity of a lifetime for servicemen. There's room to make a buck in TV. Manufacturers are turning out sets as fast as they can, and their service organizations are frantically trying to find men to install the sets. But don't be fooled. TV is a lot trickier than radio. If you figure on being a TV man in your community, now is the time to smarten up. As a starter you might look over the new Lafayette-Concord TV bulletin. It will give you a quick picture of equipment and accessories available and how much they cost. It's free. Just clip the coupon below.

RUSH THIS COUPON AT ONCE FOR YOUR FREE CATALOG

<p>SHOP IN PERSON AT ANY ONE OF OUR OUTLETS:</p> <p>NEW YORK 100 Sixth Avenue 542 E. Fordham Rd., Bronx</p> <p>CHICAGO 901 W. Jackson Blvd. 229 W. Madison St.</p> <p>ATLANTA 265 Peachtree St.</p> <p>BOSTON 110 Federal St.</p> <p>NEWARK 24 Central Ave.</p>	<p>Lafayette-Concord Dept. JJ-8 100 Sixth Avenue, New York 13 901 W. Jackson Blvd., Chicago 7 265 Peachtree St., Atlanta 3</p> <p>MAIL NOW!</p> <p><input type="checkbox"/> Please rush Free catalog No. 89</p> <p><input type="checkbox"/> Please send Free television bulletin.</p> <p><input type="checkbox"/> I enclose \$..... Please fill attached order. Shipping charges extra.</p> <p>NAME.....</p> <p>ADDRESS.....</p> <p>CITY..... ZONE..... STATE.....</p>
--	---

180 pages bulging with bargains — plus everything in famous brands. Complete coverage of TV, Hi-Fi, Ham, AM & FM Radios, P.A. Test Equipment, Parts, Tools, etc. Rush the coupon now for your free catalog.

LAFAYETTE-CONCORD

Phase Inversion Headaches



Langham gets out the iron again to try another phase inverter. Hope springs eternal . . .

By JAMES R. LANGHAM

didn't. Just a suspicion that something else is better has always set us off on a test. This time the tubes aged and before long our tap was in the wrong place. I had by this time become aware of the floating inverter shown in Fig. 2. This is a sort of self-balancing inverter. The signal applied to the grid of the inverter tube is the difference between the voltage on the output tube grids. The books say the value of R is not at all critical—just make it big.

Well, we tried it. And it worked as the books say. There is a constant difference, though, between the signal on one grid and that on the other. This difference grows less as you increase R, but with any given output tubes there is a limit to how large R can be. If you go past that limit (and we tried that too), you start popping output tubes one after the other, and 6A5-G's aren't cheap. The result was a steady 2½-db difference in levels to the grids. We tried beating that by juggling the sizes of the two 6A5-G grid resistors, but that was just beating our heads against the wall. So we went back to Old Standard.

About that time somebody showed me the split-load type of inverter illustrated in Fig. 3. That looked fine to me, and I lost no time putting it in the amplifier.

WHEN you come right down to cases, the best phase inverter is a transformer. Of course, transformers have faults: they are expensive if they're worth their salt; when they are cheap, they don't give equal amplitudes to both grids or they don't pass all the frequencies or they pick up hum or introduce too much distortion.

Way back when the XYL and I began

fooling around with audio we believed what the transformer companies said about their products. We'd look at the curves they published and wish we could afford to get one of those lovely interstage or output transformers. We actually did save up and buy one that looked lovely and for which even lovelier things were claimed. It wasn't until about a year later that we discovered this beautiful interstage gave one grid about 7 db more signal than the other, and that the frequency band—instead of being within 1 db from 20 cycles to 20 kc—was within 1 db only between 80 and 9,000 cycles.

Later I got a job in a laboratory where I was required to test a bunch of transformers, and I was amazed to discover that all the big-name jobs ran circles around their specifications. All the companies have their high-fidelity models; and they all publish curves that look as though they were drawn with a straightedge but the average guy has no facilities for checking them. My advice to anyone buying a transformer is: Find a technical school or laboratory where you can check the thing and then send it back to the factory with a letter and a curve. They'll be very nice and send you a good one then—maybe. They did us.

So, what with one thing and another, the XYL and I decided we'd use a tube to invert our phase. The first circuit we tried was the old standard kind, you know, where you tap off the grid resistor of the following stage to feed the second triode (pentodes should work as well). This one is drawn in Fig. 1.

This should have satisfied us but it

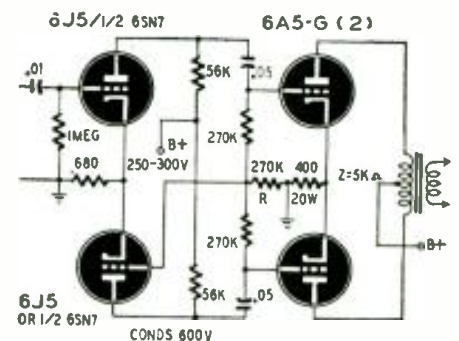

Fig. 2—R should be large for best balancing.

The plate load of the tube is split, and half put between cathode and ground. Ingenious as heck. And what's more it worked. I balanced the resistors carefully and got equal results at both grids. At 1,000 cycles, that is.

We had it in there a week or so before the XYL complained. "It doesn't sound so hot on the high notes," she said. I cocked an ear. "Sounds okay to me."

She insisted, though, and I ran a curve. Around 5,000 cycles I was getting a good 5-db difference, and, because at that time I was running the finals in AB instead of strict class A, it showed up. Oh, it works. Don't get me wrong. If you're running a PA system and you don't care about anything high up on

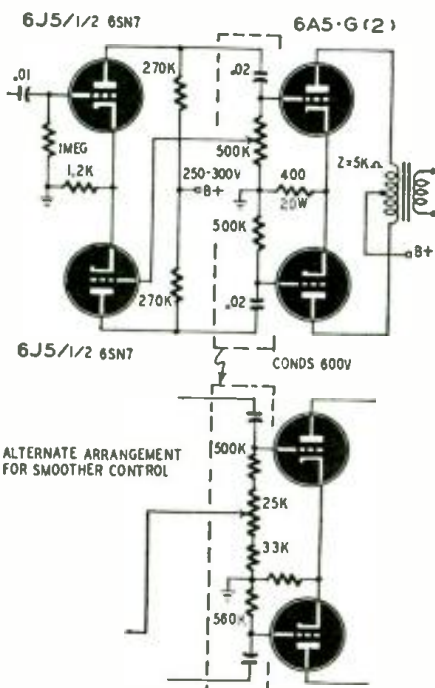

Fig. 1—Old Standard phase-inverter circuit.

the scale, why sure, go ahead and use it. It'll drive your other 6L6 very satisfactorily and the distortion won't be noticeable. But for your home rig where you want it really clean for the plastic records and FM and the really good AM stations, lay off it. Go on back to the Old Standard. We did.

During the war I got to know another type of inverter, the cathode-coupled, shown in Fig. 4. This is an ingenious way to handle inversion, and it may be a little hard to follow if you're not familiar with it. Bear in mind that a tube doesn't know whether a signal is applied between a grid and a grounded cathode or a cathode and a grounded grid. Now then, imagine a signal coming in the

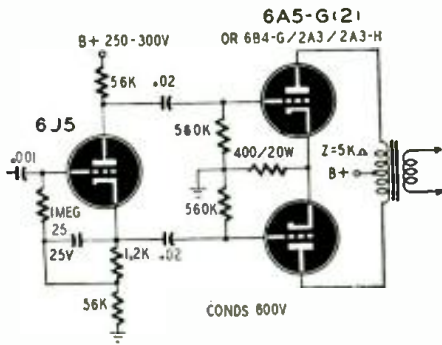

Fig. 3—Split-load inverter uses single tube.

top control grid. This signal will appear on both cathode and screen as well as plate because both cathode and screen have large, unbypassed resistances to ground (or B-plus). These voltages will modulate the electron stream in the bottom pentode. Okay? Now let's take it slowly. As the top grid goes positive, the current in the top tube goes up and the IR drop in the cathode resistance goes up. The cathodes of both tubes go positive, since they are connected together. If the cathodes are positive, the other end of the common cathode resistor—the grounded end—must be negative with respect to the cathode. The bottom grid is grounded for audio. Being at the same potential as the bottom of the cathode resistor, this grid must also be negative with respect to its cathode. Since modulating a tube is just the process of placing an audio voltage between its grid and cathode, the bottom tube is modulated. Its signal is opposite in phase to that of the top tube.

The size of the cathode resistance is a very important factor here. The higher it is, the better the inversion. Typical values of the resistors are shown in Fig. 4. With these we get a gain of approximately 100 times, and the inversion is good to a whisker better than 1 db. The frequency response is good to 20 kc and the distortion is very low. With R changed to 22,000 ohms, the inversion is almost within 1/2 db.

Now this circuit has some very interesting possibilities. Instead of grounding the bottom grid through a condenser you can center tap your pickup and take push-pull signals from there. The average tuner being single-ended, you can just tie it right in—ground either grid,

it won't make a bit of difference. You can run your feedback voltage to the bottom grid very nicely (if you don't run too much), and you can run a corrective feedback (to assist in balancing the output tubes) from the joint output-tube cathodes to the common screen or common cathode of the phase inverter. This circuit also can be worked with triodes, but bear in mind that you have no screen signals to help along the inversion.

We hitched this up and used it very successfully so long as we didn't try to put too much feedback around the output transformer. When we got a better output and tried to run over 8 db feedback, we got into trouble. The feedback voltage applied to the bottom grid can't appear so easily on the top grid because the top grid isn't grounded. That sounds silly, but, if you'll think about it a minute, you'll see what I mean. The signal appears between grid and cathode because the cathode goes positive and the grid can't. If the grid can go positive, it will; and then you no longer have your inversion.

That, plus the fact that we wanted to drive our 6A5G's with low mu triodes (to avoid Miller effect) made us discard this particular inverter; but I still say it's one of the nicest inverters I ever saw. Without feedback and with Miller effect and all, we got near-perfect inversion all the way up to 12 kc. That was where Miller effect was knocking us and that wasn't the inverter's fault. With 6L6's or any output tubes with less grid-cathode capacitance it'll go on up

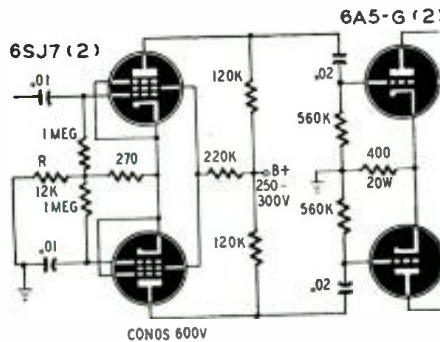

Fig. 4—Cathode-coupled inverter works well.

into the supersonic regions with no trouble at all.

We went back to Old Standard, but this time we included a refinement. We have a decibel meter on the front panel that reads the output. A switch pushes the meter over to read the signal on one output grid and then the other. We have a potentiometer in one output tube's grid circuit to tap off the inverter voltage at the correct point, and we merely flip our switch and adjust the knob till we get equal readings on the meter. Also we bias each cathode of our two driver triodes with separate resistors. This is so we can run inverse feedback to the top cathode. We have a decent output transformer and have 22db of feedback from our voice coil back to this top cathode. It works nicely. It's clean, and I recommend it heartily to all hi-fi hounds.

SIGNAL GENERATOR

MODEL 300



The Model 300 Signal Generator features finger-tip selection of four accurately aligned frequencies. Special crystal position accommodates any standard crystal to adapt the model 300 to a crystal freq. standard or TELEVISION MARKER OSCILLATOR. Four Hundred cycle audio modulation, in or out. Supplies 156 Kc, 465 Kc, 600 Kc, and 1500 Kc, to cover 90% of all receivers manufactured. Works equally well with A-C D.C. sets. Complete with tubes, and output probe. Nothing else to buy. Model 300\$16.95 Net Model 300-K Complete Kit & Instructions 14.95

"RANGE MASTER"

MODEL 10



The 9-in-1 Service Instrument Covers these 28 ranges:—

- (1) CAPACITY .001-1, .01-1, 1-10 Mfd.
 - (2) A.C. CURRENT 0-.150, 0-1.5, 0-15 amps.
 - (3) A.C. VOLTAGE 1-10-100-500-1000 volts.
 - (4) D.C. VOLTAGE 10-100-500-1000 volts.
 - (5) D.C. CURRENT 1-10-100-1000 milliambs.
 - (6) RESISTANCE 0 to 10,000-100,000-1 megohm.
 - (7) Special High range ohmmeter to 0-2 20 Megs.
 - (8) Sensitive A.C. microammeter to 500 microamps.
 - (9) OSCILLOSCOPE CALIBRATOR 1-10-100 metered RMS Volts from A.C. line.
- Model 10-P Portable (Illustrated)\$26.95 Net
 Model 10-F Fused 28.15 Net
 Model 10 Bench 23.50 Net
 Model 10-K, Complete Kit & Instructions... 17.95 Net
 Test Leads85

"MULTI-TESTER"

MODEL 30



A.C. Volts 0-12.5-25/125/250/1250 V.
 D.C. Volts 0-5/10-50-100-500-1000 V.
 D.C. Current 0-1/100 MA.
 Resistance 0-10,000-100,000-1 Meg. Ohms.
 Decibels: From minus 10 to plus 57 db.
 Model 30 (Illustrated)\$15.95 Net
 Model 30-K, Comp. Kit 13.95 Net
BARGAIN PACKAGE: One Signal Generator Model 300-K and one Multi-Tester Model 30-K, complete with probe, test leads and battery. A complete service shop in kit form. Nothing else to buy. Only \$26.50 Net
 Prices 5% higher west of the Rockies

Write for Free Catalog
 See your local distributor. If not available, write to Dept. R. 45

BRADSHAW
 INSTRUMENTS CO.

348 LIVINGSTON STREET
 BROOKLYN 17, N. Y.

Calibrating Audio Oscillators



Calibration set-up. Our author is making a careful pin-prick mark through the dial pointer.

Showing how the old oscilloscope can be used for frequencies higher than usually is considered to be possible

By RICHARD D. HENRY

for about 15 minutes. Connect the oscillator output to the vertical input of the scope and the 60-cycle test terminal of the scope to the horizontal input. If your scope doesn't have a 60-cycle test terminal, grab a 6.3-volt filament transformer and hook the secondary to the horizontal input.

Now follow this procedure for calibrating at each frequency. As you get the stationary pattern mentioned in each case, mark your oscillator dial (I used a National ACN, which is extremely handy for this purpose) very carefully so that you can reset the pointer exactly at the mark. After making each mark you can note on the dial in very light pencil the frequency. Afterward you can do a fancy pen-and-ink job.

For 60 cycles. Open up both oscilloscope gain controls (and the oscillator output control) and adjust for a properly sized and centered pattern. All you have to do is keep it in the center of the screen so you can see the edges. The oscilloscope sawtooth sweep oscillator is not used yet so switch to horizontal input so that the 60-cycle test voltage will actuate the horizontal deflection plates. Now slowly adjust the oscillator's frequency control until an O appears on the screen. The O may be lopsided but all you have to do is adjust the oscillator until the O stops moving. It should look something like one of the patterns in Fig. 1. Mark your dial 60 cycles.

For 30 cycles. Adjust the oscillator for a figure-eight pattern like that in Fig. 2, with two loops at the sides and one at top and bottom.

For 40 cycles. Adjust for a pattern with 3 loops at the sides and 2 at top and bottom. See Fig. 3.

For 300 cycles. Adjust for 5 loops at top and bottom and just one at each side of figure. This is a very important adjustment and much patience may be necessary to get the pattern to stand still. Make the mark very carefully on the oscillator dial.

WONDER whether most radiomen know that you can calibrate an audio oscillator over its entire range with an oscilloscope only. Not just up to perhaps 600 cycles—I mean all the way to 15,000!

After building and writing about the audio oscillator of which you may have read on page 28 of the August RADIO-CRAFT, I cast about for some way to calibrate the thing. My wife (believe it or not) had read somewhere about using a scope for the purpose. So had I. But I recalled that you had to have a calibrated oscillator to compare with the new one. Most of the boys I hang out with just whistle through their front teeth when they want an audio tone; not one had an oscillator.

One did have a scope, though, and he told me cheerfully that you could use the line frequency over about a 10-1 range, as far, that is, as 600 cycles. Lissajous' patterns, you know, where you count loops. This I had heard before but 600 cycles as a top limit wasn't much use.

Well, last week I got a scope anyhow, mainly because that was the only item I could get the feminine half of the partnership to okay. Pretty pictures.

So there I sat at the bench lining the oscillator up to 600 cycles. (Incidentally, the sine-wave pattern is very nice, in case you built the unit.) Idly sitting, twisting the scope knobs and watching

the screen, the great brainwave hit me. The scope could actually be used to calibrate all the way up the range! With great accuracy, too (if the 60-cycle a.c. line frequency is accurate) and without using a microscope to count loops on the screen. It's easy, it's fun, and it even works.

Very likely, most of you know the method. Maybe everyone knew it but me. But just in case you're in my class, I'll give you a step-by-step procedure. So get out that oscillator you built three years ago and never calibrated, and get hold of an oscilloscope. If you or your friends don't have one or your radio club doesn't keep one in the shack, your local serviceman can probably be talked out of his for an hour or so, or maybe over a Sunday. Since this method gives greater accuracy than comparison with another oscillator, you needn't bother him for his audio generator, even if he has one.

The only thing you have to worry about is the accuracy of your 60-cycle line frequency. If you live in a large city, generally it's all right. In certain areas served by waterpower, there may be some doubt. If your electric clock keeps time within a few seconds a week, as checked with the radio, don't worry.

The low frequencies

Start off by turning on both the scope and the oscillator and letting them cook

The balance of the range

Now remove the 60-cycle test voltage from the input to the horizontal ampli-

A CHALLENGE—Order a model 247. Disregard the unbelievably low price and compare it on the basis of appearance, quality and performance to any other Tube Tester (ANY MAKE, ANY PRICE). If you are not completely satisfied with the model 247 after a 15 day trial, return it to us for full refund—no explanation necessary. The model 247 is not surplus nor is it a hashed over pre-war model. It is newly designed and incorporates new advances in Tube Tester design. Read the description below and order one today!



Model 247 comes complete with new speed-read chart. Comes housed in handsome, hand-rubbed oak cabinet sloped for bench use. A slip-on portable hinged cover is included for outside use. Size: 10 $\frac{3}{4}$ " x 8 $\frac{3}{4}$ " x 5 $\frac{3}{4}$ ".

ONLY
\$29⁹⁰
NET

The New Model 247

TUBE TESTER

Checks octals, loctals, bantam jr. peanuts, television miniatures, magic eye, hearing aids, thyratrons, the new type H. F. miniatures, etc.

Features:

- * A newly designed element selector switch reduces the possibility of obsolescence to an absolute minimum.
- * When checking Diode, Triode and Pentode sections of multi-purpose tubes, sections can be tested individually. A special isolating circuit allows each section to be tested as if it were in a separate envelope.
- * The Model 247 provides a super sensitive method of checking for shorts and leakages up to 5 Megohms between any and all of the terminals.
- * One of the most important improvements, we believe, is the fact that the 4 position fast-action snap switches are all numbered in exact accordance with the standard R.M.A. numbering system. Thus, if the element terminating in pin No. 7 of a tube is under test, button No. 7 is used for that test.



THE MODEL 650 — AN A.C. OPERATED SIGNAL GENERATOR

RANGE: 100 KILOCYCLES TO 105 MEGACYCLES

- *RF obtainable separately or modulated by the Audio Frequency.
- *Audio Modulating Frequency—100 cycles pure sine wave—less than 2% distortion.
- *Attenuation—3-step ladder type of attenuator (T pad).
- *Uses a Hartley Excited Oscillator with a Buffer Amplifier.
- *Tubes: 6J5 as R.F. Oscillator; 6SA7 as modulated buffer and Mixer; 6SL7 as audio oscillator and rectifier.

Model 650 comes complete with coaxial cable, test leads and instructions. Housed in heavy gauge grey crystalline cabinet with beautiful two tone etched front panel. Size 9 $\frac{1}{2}$ " x 10" x 6".

\$39⁹⁵
NET PRICE:



The New Model 670 SUPER METER

A Combination VOLT-OHM-MILLIAMMETER plus CAPACITY REACTANCE, INDUCTANCE and DECIBEL MEASUREMENTS.

D. C. VOLTS: 0 to 7.5 15/75/150/750/1500/7500.—A. C. VOLTS 0 to 15/30/150/300/1500/3000. Volts.—OUTPUT VOLTS: 0 to 15/30 150 300 1500 3000.—D. C. CURRENT, 0 to 1.5/15/150 Ma.; 0 to 1.5 Amps.—RESISTANCE: 0 to 500 100,000 ohms, 0 to 10 Megohms.—CAPACITY: .001 to .2 Mfd., 1 to 4 Mfd. (Quality test for electrolytics).—REACTANCE: 700 to 27,000 Ohms; 13,000 Ohms to 3 Megohms.—INDUCTANCE: 1.75 to 70 Henries; 35 to 8,000 Henries. DECIBELS: -10 to -18, -10 to -38, -30 to -58.

THE MODEL 670 COMES HOUSED IN A RUGGED, CRACKLE-FINISHED STEEL CABINET COMPLETE WITH TEST LEADS AND OPERATING INSTRUCTIONS. SIZE 5 $\frac{1}{2}$ " x 7 $\frac{1}{2}$ " x 3".

\$28⁴⁰
NET

Available for Immediate Shipment From Stock—20% Deposit Required on All C.O.D. Orders

MOSS ELECTRONIC DISTRIBUTING CO. DEPT. RC-10 229 FULTON ST. NEW YORK 7, N. Y.

SUPER VALUES from MID-AMERICA!

Stromberg-Carlson DYNATENNA

This famous-make FM antenna has been advertised and sold for many times the low price MID-AMERICA asks! Covers both FM bands. Delivers FM reception at its best. Complete with 60 ft. of 300-ohm twin lead-in. Line is standard approved flat-type, solid dielectric with weather-resisting insulation. Mounts anywhere easily... vertically or horizontally to match polarization of trans-

mitting station. Illustrated instructions and all necessary hardware. A screw driver is only tool needed for assembly. Dynatenna is seamless, heat-treated, all aluminum... will withstand severest weather.

\$4.95 each
\$4.45 each in lots of 3



PERMEABILITY TUNER

Build a really HOT 5 or 6-tube AC-DC superhet receiver! Takes place of old-style gang condenser, of 3rd antenna coils; regular 455 KC intermediate frequency. **MA-2167** Complete with permeability tuned oscillator coil. **\$1.24** 4" x 2 1/2" x 2 1/4"; 2 1/2" diameter dial drum. Complete with diagrams for building 5 and 6 tube sets. Order **MA-2169** Loop Antenna **15c** Order **MA-2914** Drilled, punched Chassis **39c**



BANTAM 1-WATER

BGR-746-A tuning unit used as foundation for Bantam 1-Water described in Jan. 1948 QST. Makes tiny crystal-controlled CW transmitter. Measures only 3 1/2" long, 2 1/2" high, 1 1/2" wide. Requires only 1 1/2 volts "A", 30 to 90 volts "B". Draws 8 to 15 ma under load. Supplied less crystal, 1 1/4 tube and plug-in coil MA-907. **24c**

SPECIAL AUDIO TRANSFORMERS

Exceptionally high-quality universal output transformer for up to 12" speakers. Rated at 12 watts. Matches any single, push-pull or parallel tubes to 6-8 ohm voice coil. 12" color-coded leads. 2" high with 2 1/2" mounting centers for installation on chassis or speaker. Complete with instructions for matching tube impedances. **MA-1205 \$1.19**

Hermetically sealed 200 ohm CT to 50,000 ohm grid. Use as microphone transformer, line-to-grid, etc. 2 1/2" x 1 1/2". **MA-1262 69c**

Single 3000-ohm to 4-ohm voice coil output for 50L6, 35L6, etc. 1 1/2" high on 2 1/4" mounting centers. **MA-1255 49c**

Heavy Duty Noise Filters

Rated on 10 amps, 115-volt AC. Measures only 1" x 1 1/4" square. Install right in amplifiers, receivers and other equipment where line noises must be kept at a minimum. Nationally-known manufacturer. **MA-2164 79c**

Filter for mobile power supplies. Rated 10 amps, 6-30 VDC. Has additional 2 mfd, 100 VDC condenser. 2" square. **MA-2165 59c**

SPEAKER SPECIALS

All with Heavy ALNICO 5 Slugs

3 1/2" PM MA-206 2... \$1.39 4x6 Oval PM MA-2187 \$1.39
5" PM MA-2071... \$1.39 6" PM MA-2189... \$1.95

ORDER FROM THIS AD!

Quantities are limited, so get your order in now! Minimum order shipped, \$2.50. Send 25% deposit, balance C. O. D. Get on MID-AMERICA's mailing list to receive BIG BARGAIN BULLETINS that list latest, greatest buys in radio parts, electronic equipment. Send orders to Desk RC-108

MID-AMERICA CO. Inc.

2412 S. Michigan Avenue
Chicago 16, Ill.

CALIBRATING AUDIO OSCILLATORS

(Continued from page 52)

fier and switch to the internal sweep generator.

For 50 cycles. With the oscillator dial accurately set at the 300-cycle mark, adjust the coarse and fine sweep tuning controls on the scope until a pattern of exactly six sine waves appears. Carefully set the fine tuning control until the pattern stands still. *The synchroniz-*

ing wave pattern appears. Again it is a good idea to advance the horizontal gain control to spread the pattern, rather than to try to count the waves.

For frequencies above 8,000 cycles. At this point it becomes very hard to stop the pattern if the 500-cycle divisions are maintained. Generally 1,000-cycle points are sufficient. For each de-



Fig. 1—Single loop at 60 cycles.

ing control should be set at its off position. Just for safety, switch to the external sync position to be sure there is no sync voltage applied to the sawtooth oscillator. Now tune the oscillator down below the 60-cycle mark until just one sine wave appears. Tune until this stands still, then mark your dial 50 cycles.

For 100 to 1000 cycles. Starting with the single sine wave at 50 cycles, slowly advance the oscillator dial until two sine waves appear. This is the 100-cycle mark. To calibrate at 50-cycle intervals up to 1,000 cycles, adjust the oscillator dial for motionless sine wave patterns. The frequency of the oscillator will, in each case, be 50 times the number of sine waves that appear. You can easily count the waves (if there aren't too many of them) by counting the peaks at top or bottom of the pattern. When 20 waves appear you will have reached 1,000 cycles. It is not really necessary or even a good idea to count cycles above about eight (new glasses are expensive). Just keep going each time until the next sine pattern appears. You will know that that is 50 cycles higher than the last one. Open up the horizontal gain control to spread the pattern and make the wave-shape easier to see.

1,000 to 2,000 cycles. If you want to calibrate this range in 100-cycle steps, set the oscillator accurately at 100 cycles. Adjust the sweep tuning controls on the scope for a single sine wave. Now start at 1,000 cycles with a 10-wave pattern. Turn up the horizontal gain to spread the pattern nicely, then tune slowly and at each place where the sine-wave pattern appears and stops, mark. To check the 2,000-cycle point, set the oscillator at 1,000 cycles and tune the scope sweep for a stationary single sine wave. Then tune the oscillator for two sine waves. Mark 2,000 cycles. There should now be 9 marks between 1,000 and 2,000 cycles.

For 2,000 to 8,000 cycles. To mark the dial at 500-cycle intervals, set the oscillator at 500 cycles, tune the scope for a single sine wave, then proceed to tune the oscillator, beginning at 2,000 cycles and making a mark each time a sine-

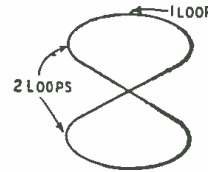

Fig. 3—40 cycles.

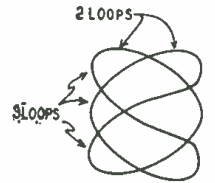

Fig. 2—30 cycles.

sired frequency marking above 8,000 cycles, set the oscillator dial at half the desired frequency, tune the scope for a single sine wave, then tune the oscillator for two waves. This latter point will be the desired frequency.

After the calibration is complete, it will not hurt matters to check the markings. That can be done as many ways as you want. It is a good idea because the sweep oscillator in the scope may drift slightly between settings.

To check, just remember that if the scope's sweep oscillator is tuned so that the screen shows one sine wave at any setting of the audio generator, any multiple of the frequency used to get the single wave will be indicated by the number of waves appearing.

AUDIO OSCILLATOR

This R-C audio test oscillator, originally described in *Sylvania News*, has a range of 50 to 5,000 cycles. It is tuned by the dual 1-megohm potentiometer. R2 is provided to vary the wave form of the output. By using an oscilloscope, the builder can produce a sine wave with less than 5% distortion, or produce tones rich in harmonics.

Varying R2 will change slightly the frequency as well as the wave form. Calibration should be done after the setting of R2 has been determined.

The frequency range can be varied by changing the values of R3 and R4.

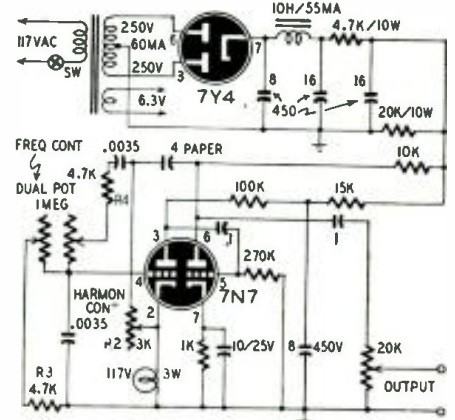

New Magnetic PICKUPS

By I. QUEEN



The Clarkstan No. 201 RV wide range pickup.

SEVERAL phonograph pickups were discussed in the September, 1947, issue. Of these types, the magnetic (or variable reluctance) has attained wide popularity. It is a rugged unit, unaffected by moisture or temperature and capable of high fidelity. Magnetics are now available from many manufacturers. In some cases the manufacturers also recommend their own preamplifiers and equalizers.

Most good magnetic pickups have practically linear response throughout their range, but all require bass boost (6 db per octave below 500 cycles or whatever crossover frequency is used). Many music lovers prefer adjustable treble response so that highs may be reduced on noisy records. In any case, a roll-off must be used to compensate for the recorded characteristic of most discs. The G-E pickup normally droops somewhat toward the high end (between 5 and 10 db down at 10 kc), and a resistor is built into the case of the Clarkstan to provide a roll-off.

The table lists the characteristics of magnetic cartridges, the most important being the frequency range. All those shown have excellent response. Where the output voltage is .05 or greater, the pickup may be connected directly to the microphone input of a high-gain amplifier. The amplifier must, of course, be properly equalized. In choosing the stylus, remember that a diamond has about ten times the life of a sapphire. A sapphire is also more easily damaged.

The Clarkstan RV pickup cartridge accommodates a removable stylus. No tools need be used to remove and replace it. Extra sapphire needles are available. Styli with tips of different radius may be had, including a .001-inch unit for playing Microgroove records. This manufacturer does not make a preamplifier, but recommends any standard unit if it is necessary. In many cases the RV may be connected directly to a high-gain amplifier.

The Pickering cartridge is a compact version of the Pickering professional pickup, which comes complete with arm. It is easily adapted to most pickup arms by the special "keystone clip" mounting into which it slides. The stylus is fixed to the cartridge, but may be replaced at the factory. A model 125-H preamplifier is recommended for the 120-M.

Very recently Pickering has introduced a model D-140S cartridge for

Microgroove recordings. The stylus is a whole diamond with a .001-inch tip radius. The cartridge will track with only 5 grams of pressure.

The Lear MP-103 uses a retractable stylus. No damage results to the stylus or record, even when the stylus is accidentally dropped. A felt pad is built around the stylus to clean away dust particles as the record moves. The model A-172 preamplifier is recommended with this unit.

Model MP-203 (also by Lear) may be used with either lateral or vertical recordings. Frequency response is approximately the same with either type. A combined preamplifier and equalizer unit, PE-210, is recommended for this pickup.

The Jensen model J-9 Magtronic pickup uses a sapphire stylus fastened into an aluminum shank with hot cement. Although the jewel may be removed and replaced by applying heat, it is best done at the factory. The excellent response up to 14 kc is attained with a load of 22,000 ohms resistance and .001- μ f capacitance in parallel. This is the minimum load which should be used.

Like the Lear MP-103, the Jensen J-9 has a retractable stylus and is provided with a felt pad around it.

Astatic has included an unusual fea-

ture in its Magneto-Induction MI pickups. No air gaps exist in the cartridge so that dust particles and metal filings are automatically excluded. The precious-metal stylus may be replaced at the factory. MI-2 is housed in a mu-metal shield for maximum protection against hum. There is a choice of two preamplifiers by Astatic. EA-1, equipped for bass boost only, may be installed inside an amplifier or radio set. Model EA-2 is self-powered and adds adjustable treble roll-off and choice of turn-over frequency.

The General Electric IRM-6C was one of the earliest variable reluctance pickups. It was described in the September, 1947, issue of RADIO-CRAFT, together with the preamplifier recommended for it. The new IRM-8C is similar but uses a diamond stylus. The Gray Research and Development Company, which for some time has been furnishing selected diamond-pointed G-E cartridges to go with the Gray arm, has announced that they will furnish a slightly modified cartridge with a .001-inch-radius diamond point and increased lateral compliance for playing Microgroove records.

Audak's R-61 pickup is available in a variety of impedances running from 5-2,500 ohms. The jewel needle is replaceable.

Manufacturer and Model	Stylus material	Frequency range	Output (volts at 1,000 c. p. s.)	Unusual feature	Min. needle pressure (grams)	List price
Clarkstan RV	sapphire or diamond (replaceable)	30-14,000	.06	needle is the armature	15	\$25 with sapphire \$45 with diamond
Pickering 120-M	D-120M uses diamond S-120M uses sapphire	40-10,000	.07	handy mounting	15	\$25 with sapphire \$60 with diamond
Lear MP-103	sapphire	50-10,000	.08	stylus is retractable	17	\$12
Lear MP-203	sapphire	50-14,000	.08 on vertical rec. .01 on lateral	plays either vertical or lateral recordings	26	\$75
Jensen J9	sapphire (replaceable) at factory	50-14,000	.08	stylus is retractable	17	\$12
Astatic MI-2	precious metal	50-12,000	.1	no air gap is used. MU metal shield	30	\$7.50
Gen. Electric IRM-6C IRM-8C	sapphire diamond	50-10,000	.022	flexible jewel mounting	22	IRM-6C \$7.95 IRM-8C \$9.50
Audak R-61	jewel (replaceable)	50-10,000	.085 (high-impedance model)		22	\$43.00

PHONO PREAMPLIFIER

Collins Audio Products Co., Inc.,
Westfield, N. J.

The I-A amplifier is used with GE, Pickering, and similar magnetic, low-level phonograph pickups. It provides the proper bass equalization for this type of pickup.

The entire preamplifier, including the tubes, is enclosed within a small metal shield can, at the bottom of which is an octal tube base. The unit is plugged into an octal tube socket which can be provided on almost any amplifier

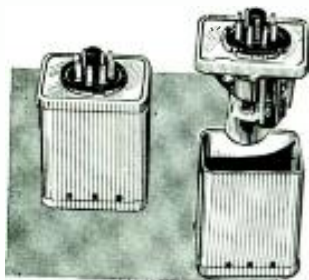

chassis. Leads from the input jack of the amplifier and from the power supply can easily be wired to the socket. B-supply requirements are 250 volts at 2 ma.

The preamplifier is especially useful where uninterrupted operation is important, as in broadcast stations and wired music studios. If the unit becomes defective, it is simply pulled out and a good one plugged in. An adapter (jumper) plug is available to reconnect the amplifier input directly to the first regular stage when a crystal pickup is to be used.

RECORDING CHASSIS

Rek-O-Kut Company,
Long Island City, N. Y.

The assembly includes the M-12 overhead cutting mechanism and the TR-12 dual-speed turntable.



The mechanism is enclosed to prevent dust and record chip from fouling the gears. An automatic safety feature raises the cutter when it reaches the inside of the disc, preventing damage to record and stylus. The mechanism, available separately, is adjustable to fit almost any 12-inch turntable.

The turntable, 12 inches in diameter, is lathe-turned from cast aluminum. The chassis is cross-ribbed for extra strength. Rim drive is used, the neoprene drivers contacting the inside rim of the table.

SQUARE-WAVE GENERATOR

General Electric Co., Inc.,
Syracuse, N. Y.

The YGL-1 square-wave generator has six overlapping frequency ranges, giving coverage from 5 to 125,000 cycles. It delivers a rectangular-wave output voltage with a 25% negative pulse and a rise time for the leading edge of 0.3 microsecond.



The self-contained power supply is electronically controlled to minimize the effect of any line-voltage variations. Output may be synchronized to an external source.

FILM RECORDER

Frederick Hart & Co., Inc.,
Poughkeepsie, N. Y.

The Hartron Model VRF-3 is a sound-recording machine which uses transparent film as the recording medium. The film, an endless 62-foot loop, is run under a recording head, the stylus of which embosses 120 parallel tracks. Four hours of continuous recording are possible.

A voice-operated relay arrangement is available to start or stop the unit automatically, and a track locator enables the user to listen to one track (through headphones) while another track is being embossed. A transformer for telephone recording is built in, and a self-contained loudspeaker, as well as connections for an external speaker are provided. A foot control and headphones are available for stenographic transcribing purposes.

**RECORD SAVER**

Penlee Mfg. Co.,
Dubuque, Iowa

Sav-A-Disc is a circular piece of very thin vinylite of the same diameter as the ordinary record label. Constant playing of a record, especially on changers, enlarges its center hole, which makes the music "wow" or waver in pitch. The Sav-A-Disc has a hole of exactly the proper size. When it is cemented to a record, the turntable center-pin passes through the hole in the small disc, which takes the place of the original hole in the record.

**SOUND-LEVEL METER**

Herman Hosmer Scott, Inc.,
Cambridge, Mass.

Utilizing subminiature tubes and new circuit techniques, the type-410-A sound-level meter represents the first light, pocket-size instrument of its kind. This new instrument features improved stability and dependability, simplicity of operation, and accuracy, in addition to the advantages resulting from its small size and weight.



The sound-level meter covers the range from 34 to 140 db above the standard ASA reference level. It includes all three standard ASA weighting characteristics to duplicate the response of the ear at various levels and has a two-speed meter. There is provision for using extension cable, optional types of microphones, vibration pickups, etc., and analyzers or filters. The unit is 10 1/2 inches long, 2 1/2 inches in diameter, and weighs only slightly over 2 pounds including batteries.

ELECTRONIC KEY

Electric Eye Equipment Co.,
Danville, Ill.

The Mon-Key electronic monitor and sending key automatically makes properly spaced dots and dashes, and produces a tone for monitoring purposes. Pressing the paddle left or right gives dots or dashes correctly timed for any speed from eight to 40 w.p.m. The mechanism uses no weights and is adjusted with two thumbnuts.

The key controls a multivibrator; dot and dash contacts switch in appropriate timing networks. The multivibrator drives a keying tube which actuates a relay having two sets of contacts. One set keys the transmitter; the other keys an a.f. monitoring oscillator feeding a 2-inch PM speaker. The unit operates from 117 volt a.c. or d.c.

WIRE RECORDER

Premier Electronic Laboratories,
New York, N. Y.

The Wiresonic has a built-in radio receiver and a turntable and pickup for playing standard records. Frequencies from 40 to 10,000 cycles are reproduced by the amplifier, which as two micro-



phone inputs and one low-gain channel. A push-pull, 10-watt output stage is included. There are separate bass and treble tone controls. An 8-inch speaker is mounted in the cover.

BROADCAST MICROPHONES

Electro-Voice, Inc.,
Buchanan, Mich.

Models 645 and 650 are high-fidelity dynamic microphones designed for FM and AM broadcast stations. Flat response extends from 40 to 15,000 cycles for the 650, and from 50 to 15,000 cycles for the 645. Output of the latter is slightly lower.

Both models are shock-mounted to reduce vibration effects. A recessed impedance-changing rotary switch allows instant selection of 50 or 250 ohms.

**TRANSCRIPTION PLAYER**

Bell Sound Systems, Inc.,
Columbus, Ohio

Model 2079 consists of a two-speed phono turntable, crystal pickup, amplifier, and 8-inch loudspeaker, all in a single carrying case. Frequency response of the amplifier is flat within ± 1 db from 60 to 10,000 cycles. A



microphone input is provided so that the unit may be used as a small PA system. Power output is 5 watts with 5% distortion. A combination bass-boost and treble-attenuation tone control is included.

D.C. POWER SUPPLIES

Radio Products Sales, Inc.,
Los Angeles, Calif.

RPS power conversion units furnish low-voltage, high-current d.c. for operating surplus equipment. Almost any piece of equipment can be powered by one of the units, various models of which furnish 14 volts at 2 to 40 amperes and 28 volts at 1.8 to 40 amperes.

Each unit contains a selenium rectifier and a transformer for operation from 117-volt a.c. No modification or rewiring of the surplus equipment is necessary. Motor tuning mechanisms, usually disabled by the normal conversions, remain in operation.

NBFM MODULATOR

Bee-Bee Electronic Co.,
Los Angeles, Calif.

Bee-Bee Model 500 is a reactance-type narrow-band FM modulator designed for converting any transmitter with pentode or triode crystal oscillator or v.f.o. to FM operation. A coaxial cable connects the output from the unit to the transmitter. The unit is for a high-impedance microphone.

The modulator operates from a separate 6.3-volt filament and 150-180-volt plate supply.

TELEPHONE PICKUP

Mid-America Mfg. Co., Inc.,
St. Louis, Mo.

This device consists of a high-impedance pickup coil enclosed in a flat case covered with simulated leather. The case is placed under the telephone instrument, which should be of the newer type (bell in base).

Coil output can be fed to the grid of an amplifier for listening or recording. A low-impedance model, made for use with the Soundscriber, is also available.

**HIGH-VOLTAGE METER**

Spellman Television Co., Inc.,
New York, N. Y.

Voltages up to 30,000 may be measured with this meter, which is intended principally for servicing projection television receivers. A 4-inch scale is provided for easy reading. The panel is of bakelite and the cabinet of oak. The meter draws only 20 μ a.

SPEAKER GRILLE

Wright, Inc.,
St. Paul, Minn.

Model 10-P flush-mounting grille is a circular piece of 18-gauge steel with grillwork as shown. It is made for mounting speakers up to 10 inches in diameter flush with walls or in the backs of automobiles. The disc is 10 inches in diameter and is not furnished with speaker cloth or mounting holes.

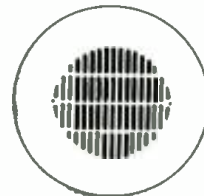
**WARNING DECALS**

Allied Radio Corp.,
Chicago, Ill.

Decals reading "DANGER-HIGH VOLTAGE!" are printed in two colors and may be attached to any equipment having exposed high-voltage terminals. The decals are 2 3/4 x 4 inches in size. They may be obtained without charge by writing to C. W. Bailey, W9JJD, at Allied.



NEW
H-16-U
Headphones **97¢**

A sensational buy. New in original overseas sealed packages. Complete with War Dept. Technical Bulletin. An ideal phone for communication work, well suited for use in noisy locations, were originally used in armored vehicles. 8000 ohm impedance 128 ohm ear-phone units with built in matching transformers. Add 30c to cover postage and handling.



A REAL BARGAIN!

77¢

Brand new **3-0-3**, DC voltmeter 2" round case. Meter has 450 ohms resistance (150 ohms per volt). (Add 15c each to cover postage and handling.)

Stock Up



WILLARD 2 VOLT BATTERIES ONLY \$1.25 each

Brand new Compact split group Built-in Hydrometer Group several together for higher voltages. Uses Standard Electrolyte. Guaranteed. Add 35c to cover postage and handling.

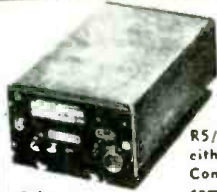

Radio Compass

NOW \$14.95

RS/ARN7 or 433G, either of these Radio Compass Receivers complete with tubes. Ideal for conversion for home reception. Used but good. A real buy at only \$14.95. (Shipped express collect.)



1300' Rubber Covered Wire ONLY \$18.00

New 4 conductor 16 gauge rubber covered cable. Color coded. Used by United States Government as Field Telephone Cable. 1300 feet on steel reel. F.O.B. Our warehouse. Shipped motor freight or express shipping charges collect.

Tubes!

- 3 CP 1 (Ind. Screen) .95
- 3 DP 1-A (Ind. Screen) .95
- 3 FP 7-A 1.35
- 3 HP 7 1.45
- (add 25c each to cover postage and handling)
- 5 FP 7 1.75
- 5 CP 1 1.95
- 5 BP 1 2.45
- 5 HP 1 2.45
- (add 35c each to cover postage and handling)
- 7 BP 7 2.65
- 7 CP 1 3.25
- (add 40c each to cover postage and handling)
- 9 GP 7 3.50
- (Shipped express, charges collect)



LOOP ANTENNA

A NEVER AGAIN BUY \$3.95

Used primarily on aircraft & Marine ADF Systems, Loop LP-21-A contains an electric motor and selsyn. These loops have been removed from salvage aircraft, but are guaranteed to be in excellent working condition. (Shipped Express Collect)

Wonderful NEW 3/4 RPM Motor \$2.95



Ideal for a beam rotor, plenty of power. Originally designed for 24 volt DC operation, but easily converted, 110 volts AC. Complete instructions included. Excellent for other uses too. Brand new, surplus, guaranteed. (Add 40c each to cover postage and handling)



PHANTOM ANTENNA

85¢

A transmitting antenna, for use on approximately 450 MC. Complete with standard coax connector. A weather-proof unit. (Add 25c to cover handling and postage.)

49¢

Western Electric Extension Control Box, Type CW 23098. Complete with mounting plate. All new in original cartons. Contains one 50000 ohm resistor, 1 toggle switch, one phone jack, one microphone jack, one test key, and one neon indicator lamp. Add 20c to cover postage and handling.

A BARGAIN!

Westinghouse, Oxygen Flow Indicator - MK II. New in original cartons, 49c, add 15c to cover postage and handling.

All merchandise subject to prior sale, minimum order \$2.00. No C.O.D. orders accepted. Michigan residents must add 3% State sales tax.

IMPORTANT!

500' \$2.95 3 CONDUCTOR TELEPHONE WIRE

3 conductor Braided insulated copper & steel telephone wire. It is made of copper for conductivity, and steel for strength. Worth at least 3c per ft. Yet due to an exceptional buy, we can now offer it at less than 1c a ft. (Shipped Express Collect)

NEW METERS 99¢

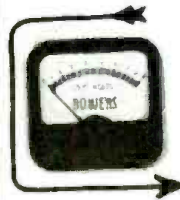

Brand new Bowers D.C. Volt meter 0 to 9 volts in 2" case with 2 3/4" Flange each .99c

Brand new Bowers D.C. Ammeter 0 to 100 amp scales (600 ma. movement with 100 amp shunt) some case as volt meter each .99c

Add 20c each to cover postage and handling

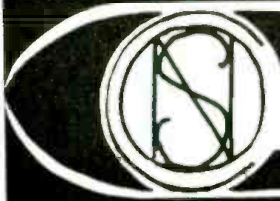

N. SILVERSTINE CO.

6532 EAST McNICHOLS ROAD DETROIT 12, MICHIGAN

"Seven Acres of Surplus"

*It's Only
Natural*

**FOR RADIO MEN TO
ASSEMBLE THEIR OWN**

**Heathkit ELECTRONIC SWITCH KIT
DOUBLES THE UTILITY OF ANY SCOPE**



\$34⁵⁰

Gives two separately controllable traces with individual inputs on any scope.
See both the input and output traces, locate distortion, phase shift, etc., immediately.
Individual gain controls and positioning control. Coarse and fine sweeping rate controls. Complete Heathkit matches others, with 5 tubes, All metal parts are punched, formed and cadmium plated. Complete with tubes, all parts, detailed blueprints and instructions. Shipping Wt. 13 lbs.
Nothing ELSE TO BUY

- ★ Save ⅓ the cost.
- ★ Gain valuable knowledge.
- ★ Achieve better workmanship.
- ★ Learn many new applications.
- ★ Ideal training for use.

Heathkits are regular factory quality test equipment unassembled but with all forming, punching, calibrating and printing already completed.

**HEATHKIT
CONDENSER CHECKER KIT**

A condenser checker anyone can afford to own. Measures capacity and leakage from .00001 to 1000 MFD on calibrated scales with test voltage up to 500 volts. No need for tables or multipliers. Reads resistance 500 ohms to 2 megohms. 110V 60 cycle transformer operated complete with rectifier and magic eye indicator tubes. Easy quick assembly with clear detailed blueprints and instructions. Small convenient size 9" x 6" x 4 3/4". Weight 4 pounds. This is one of the handiest instruments in any service shop.



\$19⁵⁰
Nothing
ELSE TO BUY

**THE NEW HEATHKIT VACUUM TUBE
VOLTMETER KIT**

The most essential tool a radio man can have, now within the reach of his pocketbook. The Heathkit VTVM is equal in quality to instruments selling for \$75.00 or more. Features 500 microamp meter, transformer power supply, 1% glass enclosed divider resistors, ceramic selector switches, 11 megohms input resistance, linear AC and DC scale, electronic AC reading RMS. Circuit uses 6SN7 in balanced bridge circuit, a 6H6 as AC rectifier and 6 x 5 as transformer power supply rectifier. Included is means of calibrating without standards. Average assembly time less than four pleasant hours and you have the most useful test instrument you will ever own. Ranges 0-3, 30, 100, 300, 1000 volts AC and DC. Ohmmeter has ranges of scale times 1, 100, 1000, 10M and 1 megohm, giving range .1 ohm to 1000 megohms. Complete with detailed instructions. Add postage for 8 lbs.



\$24⁵⁰
Nothing
ELSE TO BUY

**HEATHKIT
SIGNAL GENERATOR KIT**

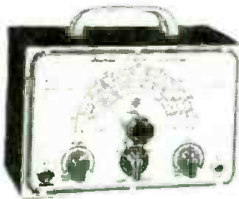

\$19⁵⁰
**NOTHING ELSE
TO BUY**

Every shop needs a good signal generator. The Heathkit fulfills every servicing need, fundamentals from 150 Kc. to 30 megacycles with strong harmonics over 100 megacycles covering the new television and FM bands. 110V 60 cycle transformer operated power supply.

400 cycle audio available for 30% modulation or audio testing. Uses 6SN7 as RF oscillator and audio amplifier. Complete kit has every part necessary and detailed blueprints and instructions enable the builder to assemble it in a few hours. Large easy to read calibration. Convenient size 9" x 6" x 4 3/4". Weight 4 1/2 pounds.

**HEATHKIT
SIGNAL TRACER KIT**



\$19⁵⁰
Nothing
ELSE TO BUY

Reduces service time and greatly increases profits of any service shop. Uses crystal diode to follow signal from antenna to speaker. Locates faults immediately. Internal amplifier available for speaker testing and internal speaker available for amplifier testing. Connection for VTVM on panel allows visual tracing and gain measurements. Also tests phanograph pickups, microphones, PA systems, etc. Frequency range to 200 Mc. Complete ready to assemble. 110V 60 cycle transformer operated. Supplied with 3 tubes, diode probe, 2 color panel, all other parts. Easy to assemble, detailed blueprints and instructions.

Small portable 9" x 6" x 4 3/4". Wt. 6 pounds. Ideal for taking on service calls. Complete your service shop with this instrument.

**HEATHKIT SINE AND SQUARE WAVE
AUDIO GENERATOR KIT**

The ideal companion instrument to the Heathkit Oscilloscope. An Audio Generator with less than 1% distortion, high calibration accuracy, covering 20 to 20,000 cycles. Circuit is highly stable resistance capacity tuned circuit. Five tubes are used, a 6SL7 and 6X6 in the oscillator circuit, a 6SL7 square wave clipper, a 6SN7 as a cathode follower output and 5Y3 as transformer power supply rectifier.

The square wave is of excellent shape between 100 and 5,000 cycles giving adequate range for all studio, FM and television amplifier testing.

Either sine or square wave available instantly at a toggle switch. Approximately 25V of sine AC available at 50,000 ohm output impedance. Output ± 1 db. from 20 to 20,000 cycles. Nothing else to buy. All metal parts are punched, formed and cadmium plated. Complete with tubes, all parts, detailed blueprints and instructions.

\$34⁵⁰

Shipping Wt., 13 lbs.



The HEATH COMPANY

DEPT. C . . . BENTON HARBOR, MICHIGAN

RADIO-ELECTRONICS for

TEST EQUIPMENT

New! HEATHKIT FM and TELEVISION SWEEP GENERATOR KIT

THE BASIC FM AND TELEVISION SERVICE INSTRUMENT

Features - ★ 5 Tube Circuit

- ★ Covers 2 Mc. to 226 Mc.
- ★ 110 V 60 cy transformer.
- ★ Supplies either RF or FM.
- ★ Variable sweep width 0 to App. 10 Mc.

- ★ Large calibrated dial.
- ★ Variable phasing control.
- ★ Sweep output for scope.
- ★ No band switching necessary.
- ★ Uses new miniature HF tubes.

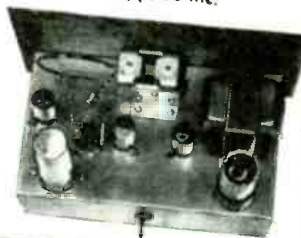

At the lowest cost possible, anyone can now service FM and television receivers. The Heathkit sweep generator kit operates with oscilloscope and covers all necessary frequencies. A few pleasant hours assembling this kit puts any organization in position to share the profits of the FM and TV boom. Every part supplied - grey crackle cabinet, two color calibrated panel, all metal parts punched, formed and plated. 5 tubes, complete detailed instructions for assembly and use. Shipping weight 6 lbs.



\$24.50

Enjoy the profits now of this new field

HEATHKIT HIGH FIDELITY AMPLIFIER KIT

Build this high fidelity amplifier and save two-thirds of the cost. Push pull output using 1619 tubes (military type 6L6's), two amplifier stages using a dual triode (6SN7), and a phase inverter give this amplifier a linear reproduction equal to amplifiers selling for ten times this price. Every part supplied; punched and formed chassis, transformers (including quality output to 3-8 ohm voice coil), tubes, controls, and complete instructions. Add postage for 20 lbs.



\$14.95

12" PM speakers for above

\$6.95

HEATHKIT 3-TUBE ALL-WAVE RADIO

110-volt AC operation

An ideal way to learn radio. This kit is complete ready to assemble, with tubes and all other parts. Operates from AC. Simple, clear detailed instructions make this a good radio training course. Covers regular broadcasts and short wave bands. Plug-in coils. Regenerative circuit. Operates loud speaker.

\$8.75



Add postage for 3 lbs.

- HS 30 Headphones per set \$1.00
- 2 1/2" permanent magnet loudspeaker \$1.95

INTERPHONE 2-WAY CALL SYSTEM KIT

Ideal call and communication system for homes, offices, factories, stores, etc. Makes excellent electronic baby watcher, easy to assemble with every part supplied including simple instructions. Distance up to 1/5 mile. Operates from 110 V. A. C. 3 tubes, one master and one remote speaker. Shipping Weight 5 pounds.



\$14.50

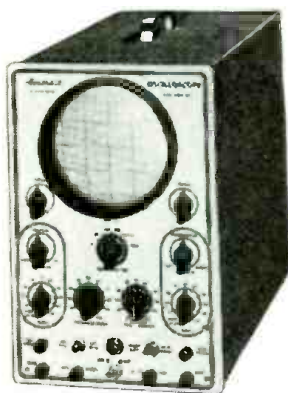

NEW 1948 HEATHKIT 5" OSCILLOSCOPE KIT

A necessity for the newer servicing technique in FM and television at a price you can afford. The Heathkit is complete, beautiful two color panel, all metal parts punched, formed and plated and every part supplied. A pleasant evening's work and you have the most interesting piece of laboratory equipment available.

Check the features - large 5" 5BP1 tube, compensated vertical and horizontal amplifiers using 6SJ7's. 15 cycle to 30 M cycle sweep generator using 884 gas triode. 110V 60 cycle power transformer gives 1100 volts negative and 350 volts positive.

Convenient size 8 1/2" x 13" high, 17" deep, weight only 26 pounds.

All controls on front panel with test voltage and ext. syn post. Complete with all tubes and detailed instructions. Shipping weight 35 pounds. Order today while surplus tubes make the price possible.

110 V. A.C. MILITARY RECEIVER POWER SUPPLY KIT

Ideal way to convert military sets. Supplies 24 Volts for filament - no wiring changes inside radio. Also supplies 250 V. D.C. plate voltage at 50-60 MA. Connections direct to dynamotor input. Complete with all parts and detailed instructions. Ship. Wt., 6 lbs.

\$ 5.95



110 V. A.C. TRANSMITTER POWER SUPPLY KIT

For BC-645, 223, 522, 274N's, etc. Ideal for powering military transmitters. Supplies 500 to 600 Volts at 150 to 200 MA plate, 6.3 C.T. at 4 Amps, 6.3 at 4 Amps and 12V at 4 Amps. Can be combined to supply 3-6-9-12 or 24 Volts at 4 Amperes. Kit supplied complete with husky 110V 60 cycle power transformer, 5U4 rectifier, oil filled condensers, cased choke, punched chassis, and all other parts, including detailed instructions. Complete - nothing else to buy.

\$14.50

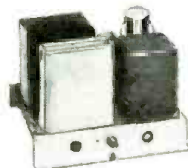

The **HEATH COMPANY**

DEPT. C . . . BENTON HARBOR, MICHIGAN

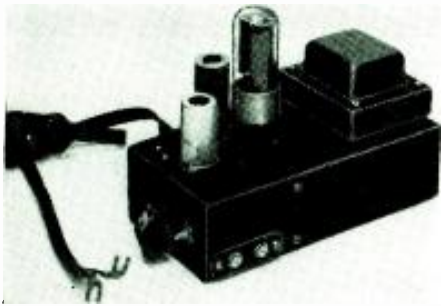

Top view of preamp. 6AK5 is in foreground.

Cascode Preamp Reduces TV "Snow"

By I. QUEEN

AT TV frequencies the useful transmission range is limited to approximately line-of-sight. TV transmitters are located in populated centers to provide maximum coverage. About eight or ten miles from a station the signal strength begins to drop off rapidly, leaving fringe areas where average reception is only fair or poor. In these areas a preamplifier can provide much-improved picture and sound. Besides giving extra gain it reduces interference such as often results from direct pickup by the i.f. channel.

There are other instances where preamplification is necessary. Apartment-house owners sometimes do not allow roof antennas, but an indoor antenna

may not be sufficient. The local stations may be picked up, but they are usually accompanied by noise or "snow."

The r.f. preamplifier described here has been found really effective. It is capable of really appreciable amplification, not merely a slight theoretical gain which shows up only on a sensitive meter. Designed for TV channels 2 through 6, it can also be used on the 88-108-mc FM band. At reasonable distances from the transmitter a small wire is sufficient to give satisfactory reception when the preamplifier is added. Fig. 1 is the schematic. Two tubes are used in a single stage of amplification. The circuit is called a "cascode." The 6AK5 has its cathode grounded, the 6J6 its grid.

The cascode, described in the *Proceedings of the IRE*, June, 1948, has several unusual characteristics. The total gain and internal noise is due to the first tube only. The 6AK5 is connected as a triode for that reason. The 6J6 merely stabilizes the system and contributes practically nothing to either noise level or gain.

The experimental model (Fig. 2) was built with its own power supply for convenience. If power can be taken from the TV set, the unit can be made even more compact.

The coils, except L2, were found to be noncritical. For L2 a National type AR-5, a permeance-tuned, high-Q coil, was used. For television frequencies the core is screwed almost all the way in. For FM it is brought out.

L1 is 2½ turns of push-back wire around L2. L3 and L4 are wound on ¼-inch polystyrene rod with No. 22 wire, 11 turns for L3 and 14 for L4. RFC consists of 15 turns of No. 22 wound over a 100-ohm insulated resistor. The 20-μf tuning capacitor across L2 is a six-plate miniature air condenser.

The preamplifier was designed for use with 300-ohm twin-lead conductors. Experiments showed that the tightly coupled 2½-turn coil L1 worked best in the antenna circuit. However, gain was very low when the same thing was tried in the output circuit. Capacitive coupling proved best.

It is not necessary to use r.f. chokes in the filament circuits. They were tried, but no improvement was noted.

Both tubes were operated with 100 volts on the plates. A noticeable gain increase is obtained when the voltage is raised to approximately 135. However, it is better to use the lower value unless maximum gain is essential. No hum was noticed in either picture or sound even when the power-supply filter was shorted out.

The band pass is very wide. We were unable to notice any loss of detail on any of the local patterns (channels 2, 4, 5). The variable condenser is not critical, but there is a definite tuning effect from one station to the next. There is no evidence of self-oscillation when parts are laid out as shown and leads are made as short as possible. The preamp was stable even when the antenna was disconnected.

Here are some actual results obtained. Low signal strength which was just

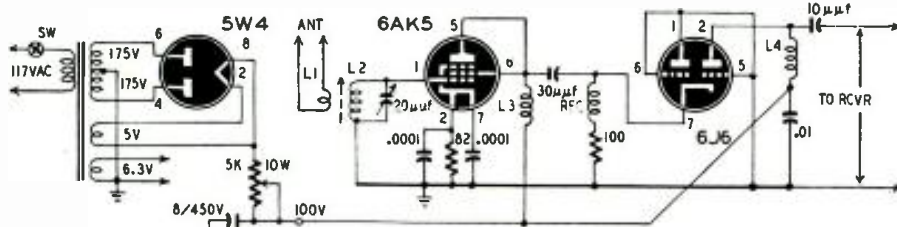

Fig. 1—Schematic of preamp. 6AK5 is triode-connected. 6J6 isolation stages give no gain.

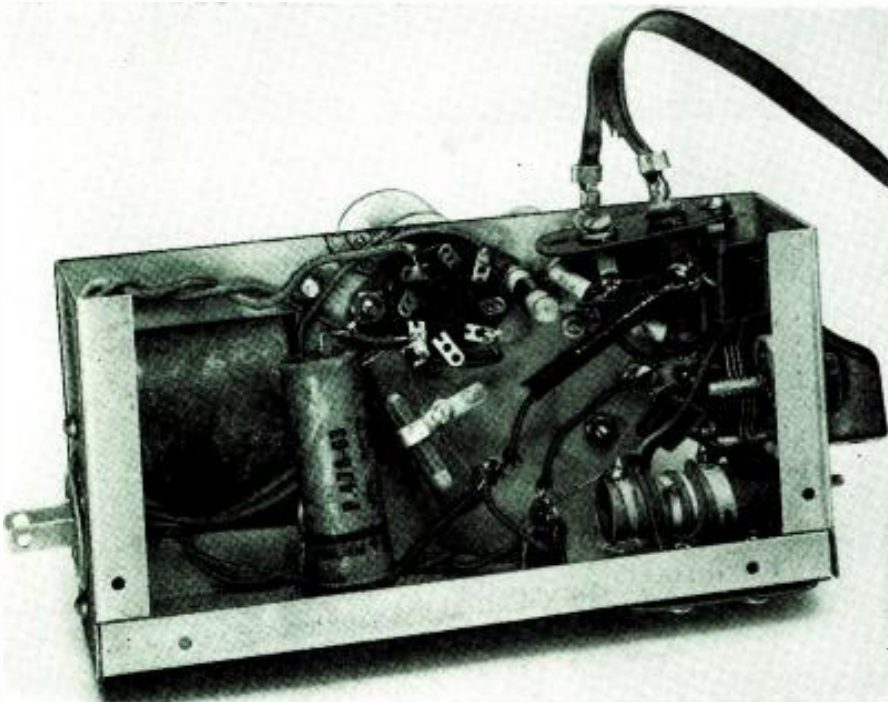

Fig. 2—Underchassis view. Coil at lower right corner is L2. Twin lead is on output strip.

short of producing any picture at all was increased to produce a fairly good image. A weak picture was increased to very good.

Since this unit introduces so little noise of its own, it can also be used where there is already enough signal level but too much noise. If the TV set gain is reduced by the amount of gain that the preamplifier adds, the same picture will appear, but with practically no "snow." This assumes that most of the "snow" is due to the input circuit of the TV set.

INDOOR TV ANTENNA

The problem of installing adequate receiving antennas is denying television reception to many would-be set owners, particularly those in large apartment buildings and housing developments. In many instances, landlords will not permit tenants to install TV antennas on buildings or grounds.

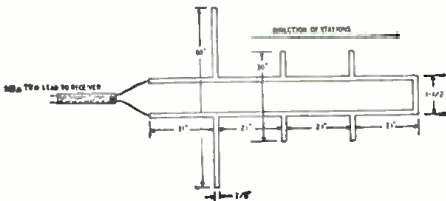

An indoor under-the-rug television receiving antenna described recently in *Electronics* may provide a satisfactory solution to the antenna problem in many instances. The antenna shown may be cut out of a thin sheet of copper or made from 3/8-inch copper strips riveted and soldered together. This antenna is a high-gain, end-fire array consisting of three elements which connect to a 300-ohm line through matching stubs. The array is highly sensitive, and it is said to be sufficiently directive to discriminate against ghosts. Several of these units can be paralleled to improve the performance.

13 1/2 MILLION VIDEO SETS BY '52

Television is already giving radio some serious competition—and promises more—for, "ready or not," it has started to roll and "is not holding up for anyone." So says the advertising agency of Lennen & Mitchell, Inc., of New York, in a study recently completed on "Current Television Facilities, Programs, and Audience." Television, the agency states, is fast heading toward the status of a \$6,000,000,000-a-year industry, four times the size of radio.

Lennen & Mitchell estimate that the cost of developing television will run to \$800,000,000 in the next several years for stations and sets alone. This does not include program costs, which the industry hopes advertisers will assume.

Eighty million dollars of the above total represents the cost of constructing the allocated number of stations permitted by the Federal Communications Commission.

OCTOBER, 1948

TRANSVISION



NEW Television Kits, and Equipment

Important Advances in TV Reception and Servicing!

Transvision makes television more enjoyable, more profitable!



Model 10 BL TV/FM KIT



New... FIELD STRENGTH METER

TRANSVISION manufactures the most extensive line of high quality Television Kits, Cabinets, Components and special equipment. Illustrated and listed here are only a representative few of Transvision's leading values. See your distributor.

MODEL 10BL TV/FM Kit, gives 115 sq. in. picture; complete FM Radio; receives all channels; streamlined cabinet..... **NET \$299.00**
 Roto-Table for Model 10BL, gives full 180° visibility..... **NET \$ 24.95**

MODEL 7CL TV Kit, gives 60 sq. in. picture; console cabinet with Roto-Table; streamlined design..... **NET \$199.00**
 Roto-Table for Model 7CL, gives full 180° visibility..... **NET \$189.00**

MODEL 7BL, same as 7CL except that it is a table model.....
 All prices include cabinets, tubes, antenna, and 60 ft. of lead-in wire. (Models 7CL and 7BL can be supplied with complete FM Radio for small additional cost.)

NEW... TRANSVISION FIELD STRENGTH METER...

IMPROVES INSTALLATIONS! SAVES 1/2 THE WORK!

Has numerous features and advantages, including—(1) Measures actual picture signal strength... (2) Permits actual picture signal measurements without the use of a complete television set... (3) Antenna orientation can be done exactly... (4) Measures losses or gain of various antenna and lead-in combinations... (5) Useful for checking receiver re-radiation (local oscillator)... (6) 13 CHANNEL SELECTOR... (7) Amplitudes of interfering signals can be checked... (8) Weighs only 5 lbs... (9) Individually calibrated... (10) Housed in attractive metal carrying case... (11) Initial cost of this unit is covered after only 3 or 4 installations.

Transvision Field Strength Meter, Model FSM-6, complete with tubes..... **NET \$99.50**



New... ALL-CHANNEL BOOSTER



New... REMOTE CONTROL UNIT

TRANSVISION ALL-CHANNEL TELEVISION BOOSTER

To achieve television reception in weak signal areas, or areas which are out of range of certain broadcast stations, Transvision engineers have designed this new booster. It increases signal strength on all 13 television channels. Tunes all 13 television channels continuously. Can be used with any type of television receiver. Unusually high gain in upper television channels. Model B-1..... **LIST \$39.95**

TRANSVISION REMOTE CONTROL UNIT...

This remarkable unit makes possible the tuning of a television receiver from a distance as far as 50 feet. Turns set on, tunes in stations, turns set off. Ideal for installations where the television receiver is inaccessible. Tuner unit is a high gain, all-channel unit with about 50 microvolt sensitivity.

Model TRCU..... **LIST \$49.00**
 Without cabinet..... **47.00**

NEW 8-PAGE CATALOG showing complete Transvision line now available at your distributor, or write to:—

TRANSVISION, INC. Dept. R.C. New Rochelle, N.Y.

IN CALIF.: Transvision of California, 8572 Santa Monica Blvd., Hollywood 46
 All prices 5% higher west of Mississippi; all prices fair traded.



Television Sweep Circuits

Part I—Basic theory of the multivibrator oscillator and its application in television receivers

By ALLAN LYTEL*

THE sweep circuits of the modern television receiver are of vital importance, but they are not difficult to service or to understand. They are of two main types, the multivibrator and the blocking-tube oscillator.

The most common type of multivibrator is illustrated in Fig. 1. This is essentially two stages of resistance-coupled

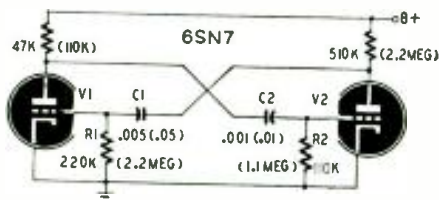

Fig. 1-a—Basic circuit of the multivibrator.

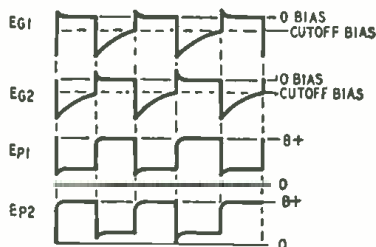

Fig. 1-b—Plate and grid voltage wave forms.

amplification, each stage being R-C-coupled to the other. Fig. 1 is an illustration of the *free-running* multivibrator, which gets its name from the fact that no input signal is required to begin oscillations. No two tubes or parts can ever be exactly matched, hence when this circuit is first placed in operation one tube conducts more heavily than the other. If we assume that V1 conducts more heavily, its plate voltage will be lowered. This places a negative voltage on the grid of V2. V2 will then conduct less and its plate voltage will rise, coupling a positive grid voltage to V1. The action occurs very quickly and V1 is at saturation while V2 is at cutoff, an unstable condition for the circuit.

When C2 discharges through R2, V2 is no longer at cutoff. It begins to conduct, and the circuit reverses itself so V1 cuts off and V2 conducts heavily.

The frequency is determined by the time constants of the circuit. If this is a balanced circuit in which C1 equals C2 and R1 equals R2, Fig. 1-b) will show the wave forms. If that is not true, as with the values given, the outputs will be unbalanced, as may be seen from Fig. 2. The degree of unbalance depends upon

the relative values of the two time constants. An unbalanced circuit is used in commercial applications because the function of the multivibrator is to act as a switch for the charging condenser.

The oscillator is used either at the vertical frequency of 60 c.p.s. or at the horizontal frequency of 15,750 c.p.s. Values for horizontal operation are given; those for vertical operation are in parentheses.

Synchronization

A signal derived from the synchronizing pulses of the television signal is usually applied to the multivibrator to keep it in step. This keeps the sweep voltage, developed by the multivibrator, synchronized with the video signal so the picture will be steady. Without an applied sync signal (when no station is being received), the oscillator will continue to operate and sweep the electron beam across the tube face. This will prevent a spot from being burned in the tube face coating.

The sync signals or triggers are applied to the grid of V1, causing the multivibrator to remain in step with the entire television system. This action may be followed by looking at the wave forms in Fig. 3 where the multivibrator is caused to follow the sync signals. Normal operation of the multivibrator is indicated for the first two cycles with

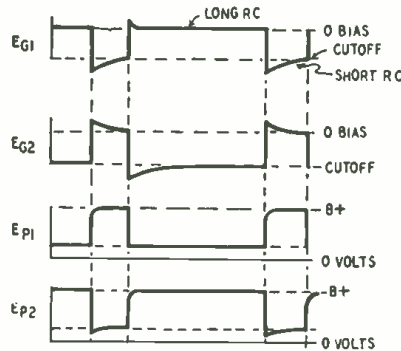

Fig. 2—Wave forms in an unbalanced circuit.

the oscillator synchronizing after that. A capacitor is placed between the V2 plate and ground to develop a sweep voltage for the cathode ray tube.

The sweep and the retrace have different time durations so the circuit must be unbalanced—C2-R2 must not be the same as C1-R1. Since the sweep time is to be longer than the retrace, C2-R2 is made about ten times the value of C1-R1. R2, in the grid circuit of V2, is made variable and is used to vary the

time constant to assure that this oscillator will lock in with the sync signals. This is the "hold" control.

A modified version, the cathode-coupled multivibrator, is used in a great many receivers where a common cathode resistance assists in the coupling between tubes. Fig. 4 shows the rearrangement of the circuit as used for horizontal sweep in the Belmont 22AX-22. The action of this circuit is very much the same as that of the standard multivibrator of Fig. 1.

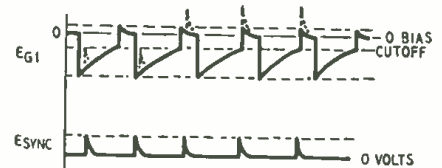

Fig. 3—Effect of superimposed sync signal.

Other multivibrators, although not in current use, are also of interest. The direct-coupled multivibrator appears in Fig. 5. This circuit uses direct coupling between grid and plate, a C-bias source, and an input trigger. Two input pulses are required to obtain one output pulse. The circuit has two stable conditions of operation: either V1 is conducting and V2 is at cutoff, or V2 is conducting and V1 is at cutoff. No other condition is possible; and, if one condition is disturbed, the circuit immediately changes to the other. The fundamental multivibrator action applies here, and a trigger of proper polarity either starts or stops the tube from conducting. The wave forms illustrate that V2 is conducting and its plate voltage is low; hence a positive trigger will affect V1, but not V2. A negative trigger will affect V2, but not V1.

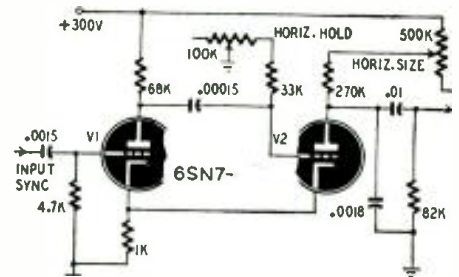

Fig. 4 Typical cathode-coupled multivibrator.

When V1 conducts, the entire circuit flips to the other state. This conduction reduces the plate voltage of V1 and the grid voltage of V2, which is a continu-

(Continued on page 64)

RADIO-ELECTRONICS for

* Temple University Technical Institute, Philadelphia, Pa.

TWO GREAT BOOKS . . . COVERING EVERYTHING IN RADIO & TELEVISION

EVERYTHING IN RADIO AND ELECTRONICS IN ONE BOOK!

THE RADIO DATA BOOK

the only radio handbook of its kind . . . 1148 pages . . . 12 sections, each covering a radio subject more completely than any other book!

Used by Engineers, Servicemen, Designers, Laboratory Technicians, Draftsmen, Operators, Inspectors, Amateurs, Experimenters, Research Development, Consultants, Broadcast Technicians, Planners, Installation Men, Military, Marine, Police, Fire, Forestry and Railroad Communications.

Anyone and everyone in radio and electronics can use this book!

SECTION 1. 150 BASIC CIRCUITS

Each circuit properly classified and clearly labeled for instant reference! Every basic operating unit in the entire field of electronics for the convenience of everyone in radio—150 circuits—completely illustrated—ALL in this one section!

SECTION 2. TEST EQUIPMENT

All types of volt, current and ohmmeters, tube checkers, condenser meters, inductance meters, bridge measuring devices, RF signal generators, AF signal generators, signal tracers, distortion analyzers, test speakers, oscilloscopes, square-wave generators, frequency meters, field strength and tuning meters are explained and illustrated.

SECTION 3. TESTING AND MEASURING

How to use test equipment and make every kind of measurement in radio. This section alone is worth the price of the entire book.

SECTION 4. ANTENNAS

This section presents complete information on all antennas, transmitting and receiving. Completely illustrated, showing various types of antennas, their construction and wave patterns.

SECTION 5. SOUND SYSTEMS

The planning, selection of equipment and the assembling and combining of various components in complete PA installations. Every type of unit used is described and analyzed in detail.

SECTION 6. RECORDING

This section is the only complete description of disc recording found in any radio manual on the market. Here all phases of recording are covered—both home and commercial.

SECTION 7. TUBE MANUAL

The only uncommercial tube manual giving complete listing of all transmitting and receiving tubes with each tube base illustrated alongside the description.

SECTIONS 8 & 9. CHARTS, FORMULAS, CODES, GRAPHS, SYMBOLS

Here in these two sections are found all data and information useful to anyone in radio and electronics.

SECTION 10. 50 TESTED CIRCUITS

98% of all equipment built in radio & electronics is covered here in a section presenting the typical circuit with parts lists and descriptions of each type. This is by far the most useful collection of circuits ever presented.

SECTION 11. DICTIONARY OF ELECTRONIC TERMS

This dictionary will explain every radio term—any word used in radio.

SECTION 12. BIBLIOGRAPHY

Here is a unique and valuable list of books for anyone desiring further details on any subject in Radio.

12 complete books in one only
Less than 42c per book!

\$5.00!

THE MOST COMPLETE TELEVISION MANUAL

THE VIDEO HANDBOOK

768 pages . . . 14 sections, covering every phase in television . . . over 800 illustrations . . . handsomely bound in Du Pont Fabricoid with red and silver letters.

How Television Works. Basic . . . through advanced.
How to Design and Engineer Television.
How to Troubleshoot and Repair Television. Safety procedures.
How to Select and Install a Television Antenna.
How to Create a Television Show.
How to Build an Operating Television Receiver. Complete instructions.
How to Select a Television Receiver.



SECTION 1. TELEVISION, PAST, PRESENT AND FUTURE

Here you will find an account of the inventions, discoveries and developments that led to the present system of television.

SECTION 2. FUNDAMENTALS OF ELECTRONIC TELEVISION

In this chapter, a simplified explanation of the complete electronic television system is given.

SECTION 3. THE TELEVISION STATION—PICK-UP—CONTROL—TRANSMISSION

Each operation and piece of equipment is taken in a step-by-step presentation, illustrated with photographs, schematics, white on black scope patterns and graphs, and simplified line drawings.

SECTION 4. THE TELEVISION RECEIVER

Each stage is individually studied and its function completely described as a unit and in relation to all the other stages.

SECTION 5. TELEVISION ANTENNA SYSTEMS

The proper antenna for the various receivers and locales are explained.

SECTION 6. CREATING A TELEVISION SHOW

Programming and Production

In television programming is tightly interwoven with technical operation—the man who knows this and studies both will profit greatly.

SECTION 7. DESCRIPTIONS OF MODERN TELEVISION RECEIVERS

Circuit variations—Design—Mechanical Features

This section includes a circuit diagram of every type of receiver on the market today.

SECTION 8. INSTALLING TELEVISION RECEIVERS

Every step is covered . . . pre installation surveys, equipment required, locating and erecting the antenna, laying transmission lines, locating the receiver in the building.

SECTION 9. SERVICING TELEVISION RECEIVERS

Troubleshooting—Interpreting Test Patterns—Alignment—Repair

This is another section devoted to detailed, how-to-do-it procedure, this time on servicing the receiver.

SECTION 10. TELEVISION TEST EQUIPMENT. HOW TO USE IT—HOW TO BUY IT

Section 10 of the VIDEO HANDBOOK was expressly designed to give you this information—it can save you as much as \$1000.00 in purchasing test equipment.

SECTION 11. BUILDING A TELEVISION RECEIVER

Included here are complete plans, diagrams, photographs of components needed and step-by-step assembly instructions.

SECTION 12. DATA SECTION

Here are compiled all the graphs, charts, curves, nomographs, symbols, formulas and rules used in television.

SECTION 13. TELEVISION TERMS

A complete dictionary of words, terms, phrases and titles used in television.

SECTION 14. BIBLIOGRAPHY

This is the most complete list of literature on television issued to date.

ADVANCE SALE \$5.00
ORDER NOW!

These books are best sellers in the radio and television field. Make sure you get your copies . . . order now! Use this coupon to order either one or both books—get them both, you'll profit by the valuable information they contain!

Mail This Coupon to Your Jobber Today — or Direct to:
BOLAND & BOYCE, 460 Bloomfield Ave., Montclair, N. J.

RC 10

Send me 1 RADIO DATA BOOK
 I enclose \$5.00 (\$5.50 Foreign)
 I enclose \$1.00 and will pay postman \$4.00 on delivery (in U. S. only)

Send me 1 VIDEO HANDBOOK
 I enclose \$5.00 (\$5.50 Foreign)
 I enclose \$1.00 and will pay postman \$4.00 on delivery (in U. S. only)

NAME
 ADDRESS
 CITY ZONE
 STATE

BOLAND & BOYCE INC., PUBLISHERS

FREE--WHILE THEY LAST!

Wiring diagram for 5 tube AC-DC set. These excellent diagrams won't last long—so send for your free copy today!

MILWAUKEE

AUTOMATIC RECORD CHANGER

only \$13.95



Complete with I-82 Astatic Crystal Cartridge, Mounting Springs and Full Instructions. A terrific buy!

VOLUME CONTROL Bargains



Nationally advertised brand. An exceptional value! All brand new.

- 10,000 ohms V.C. with switch, 3/8" shaft
- 25,000 ohms V.C. with switch, 3/8" shaft
- 50,000 ohms V.C. with switch, 3/8" shaft
- 100,000 ohms V.C. with switch, 3/8" shaft
- 250,000 ohms V.C. with switch, 3/8" shaft—Tapped
- 500,000 ohms V.C. with switch, 3/8" shaft—Tapped
- 1 meg ohms V.C. with switch, 3/8" shaft—Tapped
- 2 meg ohms V.C. with switch, 3/8" shaft—Tapped

only 44c ea.

OIL FILLED CONDENSERS

Standard Brand, Upright Type, Stand-Off Insulators

4 Mfd. 600 VDC	\$.45
6 Mfd. 600 VDC69
7 Mfd. 600 VDC74
8 Mfd. 600 VDC79
10 Mfd. 600 VDC89
8 Mfd. 1000 VDC	1.90



SPEAKER Specials

(Top quality, precision-built speakers at absolute minimum cost.)

3" P.M.—.68 oz Alnico V	\$.99 ea.
3" P.M.—1.17 oz Alnico V	1.15
4" P.M.—1.02 oz Alnico V	.99
4" P.M. Speaker	1.89
5" P.M.—1.02 oz Alnico V	.99
5" P.M.—1.47 oz Alnico V	1.15
6" P.M.—2.15 oz Alnico V	1.55
8" P.M.—2.15 oz Alnico V	2.75
8" P.M.—3.8 oz Alnico V	3.69
10" P.M.—6.8 oz Alnico V	4.39
12" P.M.—3.2 oz Alnico V	4.95
12" P.M.—6.8 oz Alnico V	5.95
12" P.M.—21 oz Alnico 3 with 6V6 P.P. Output\$7.95 complete
8" Dynamic 680 ohms field with 6V6 P.P. Output3.95 complete
12" Dynamic 680 ohms field with 6V6 P.P. Output6.95 complete
12" Dynamic 1000 ohms field5.95

IF TRANSFORMERS



Medium Size 156 KC IF Transformer—Input & Output32c ea.
 Medium Size 156 KC IF Transformer with AVC Tap39c ea.
 Budget Size 156 KC IF Transformer—Input & Output49c ea.

MICROPHONE CABLE



A—18 Strands Silver Plated Tinsel, B—Double Sealing Cellulose Acetate, C—Yarn with Moisture Proof Treatment, D—Black Braid, E—Salt and Pepper Braid, F—Braid of Tinned Copper, 4 Strands #36 B & S, G—Cotton Seive, H—1/16 Rubber Jacket, Black 60% Rubber Compound.

only 4c per foot

MINIMUM ORDER \$1.00

WHEN ORDERING—Send 25% deposit for all C.O.D. Shipments. Include sufficient postage—excess will be refunded. Orders without postage will be shipped express collect. All prices F.O.B., New York City.



Dept. A, 73 West Broadway
 New York 7, N. Y. BEEKMAN 3-6498

TELEVISION SWEEP CIRCUITS

(Continued from page 62)

ing action until V1 is conducting and V2 is at cutoff. According to the wave forms, there must be two of these triggers—negative or positive—to obtain one single square-wave output since this circuit remains in a given condition after the trigger impulse is removed. There are therefore two triggers required at the input for a single square-wave output.

The pulse amplitude required for positive triggering is somewhat greater than for negative triggering. This difference in triggering amplitude is not great enough for the circuit to discriminate between negative and positive syn-

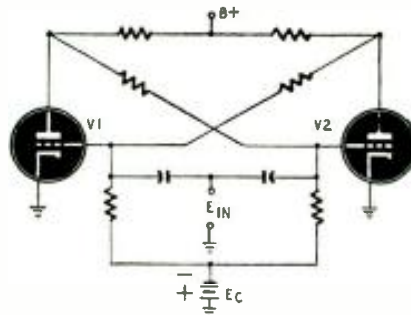

Fig. 5-a—The direct-coupled multivibrator.

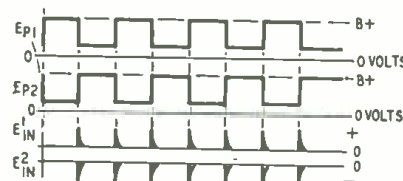

Fig. 5-b—Two impulses produce a full wave.

chronization signals. Limiters or clippers are usually used ahead of the multivibrator to remove the unwanted pulses that might otherwise cause erratic and unstable operation.

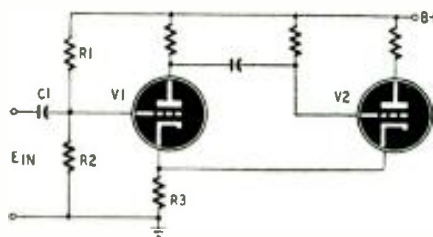

Fig. 6-a—The single-shot type multivibrator.

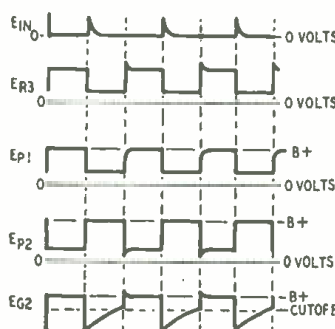

Fig. 6-b—Wave forms of multivibrator above.

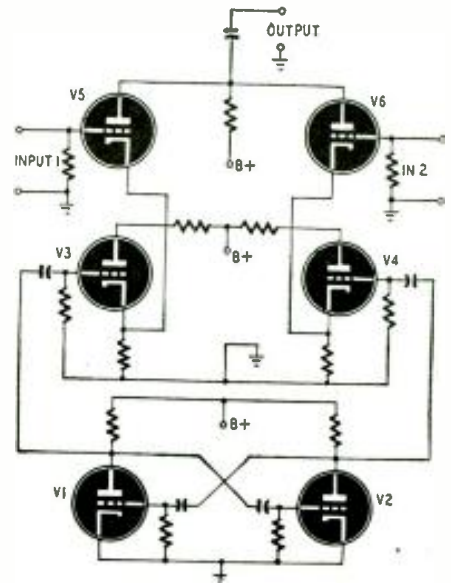

Fig. 7—Double-tracker for an oscilloscope.

Another interesting multivibrator is the single-shot type of Fig. 6 which uses a positive grid return. A voltage divider R1-R2 is used to keep a positive potential on the grid of V1, and a positive grid return produces a positive potential on the grid of V2. V2 is the normally conducting tube, and V1 is cut off because of the bias across R3, bias due to the total plate currents for both tubes. This multivibrator will produce a single square-wave output for a single input trigger.

Electronic switch

Among the many uses of the multivibrator is the electronic switch shown in Figure 7. This is used to present two pictures on an oscilloscope at the same time. At the heart of this device is a free-running multivibrator V1-V2. V3 and V4 are squarer tubes used to clip the ends of the outputs of the multivibrator.

Common cathode resistances are used for V3 and V5 and for V4 and V6 to couple the squarer tubes to the amplifier tubes V5 and V6. When V3 conducts, the heavy plate current causes a large IR drop in the cathode resistance, which is a great enough bias to cut off V5. During this time V4 is not conducting, and therefore V6 has only the bias due to its own plate current. This means that either V5 or V6, but not both, may be conducting at any one time.

The output voltage is fed to the signal circuits of the test 'scope so that the two input signals may be seen. Actually first one signal and then the second appears, but the rate of switching is so rapid that the two signals appear to be present at the same time. This is a useful method of comparing wave forms in alignment procedures and may also be used to compare two signals coming from two different antennas in radar receivers.

THOUSANDS OF TUBES

SENCO LEADS THE TUBE PARADE IN SUPER VALUES!

INDIVIDUALLY CARTONED

Here's the final answer to your tube problem. Again we've gone the limit — cutting off every bit of overhead expense that unnecessarily adds to your cost. Result: lowest prices on the market today! So why not take advantage of these tremendous savings now.

IMMEDIATE DELIVERY

R.M.A. GUARANTEE

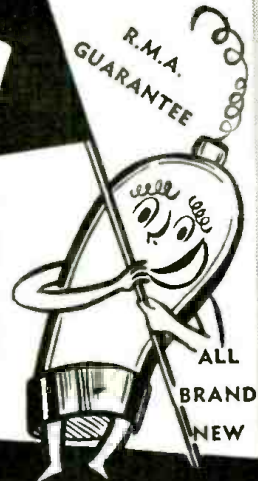

ONLY SENCO CAN OFFER THESE TREMENDOUS SAVINGS!

Type	Each	Lots of 10 Each	Type	Each	Lots of 10 Each	Type	Each	Lots of 10 Each	Type	Each	Lots of 10 Each
OZ4	69c	59c	6AL5	49	38	6U6	49	39	32L7GT	52	48
1A3	45	39	6AU6	49	39	6U7G	35	25	34	69	59
1A5GT/G	59	49	6AV6	49	39	6V5G	59	49	35/51	42	32
1A7GT/G	55	45	6B7	55	49	6V6GT/G	45	39	35L6GT/G	45	39
1C6	75	68	6B8G	99	89	6X5GT/G	49	39	35W4	43	40
1E7	99	89	6BE6	49	38	7A4	53	43	35Y4	43	40
1H4	59	52	6BJ6	59	49	7A7	59	49	35Z3	44	35
1H5GT/G	59	49	6C4	29	25	7B6	44	35	35Z5GT/G	43	39
1H6	74	69	6C5GT	40	35	7F7	49	44	37	35	29
1J6	80	72	6C6	45	32	7J7	54	49	38	45	39
1L4	49	45	6C8G	37	29	7N7	49	44	39/44	25	19
1LA4	49	39	6D6	49	45	7X7	49	44	41	49	45
1LH4	69	59	6F5	55	45	(XXFM)	44	35	42	47	41
1LN5	69	59	6F6GT	45	39	7Y4	44	35	43	54	47
1N5GT/G	59	49	6F7	49	39	12A6	29	25	45	49	39
1R5	55	49	6F7-VT70	49	39	12A8GT	35	28	45Z5GT	59	49
1S5	59	55	6H6GT/G	45	39	12AT6	50	45	47	49	39
1T4	69	55	6H6GT/G	45	39	12AT7	69	59	50A5	49	39
1T5GT	59	49	6J5GT/G	45	39	12BA6	50	45	50B5	60	55
1U5	36	30	6J6	59	49	12BE6	50	45	50L6GT	42	32
1V	45	39	6J8	73	65	12F5GT	35	27	50Y6GT	50	45
2A3	80	72	6P5GT	59	49	12H6	39	34	56	55	45
2A5	54	43	6J7GT	42	38	12J5GT	25	19	57	45	39
2A6	45	35	6K6GT/G	45	39	12J7GT	45	39	58	45	39
2A7	49	39	6K7G	50	41	12K7GT	45	39	59	65	59
2X2, 879	35	29	6K7GT/G	49	39	12K8Y	35	25	71A	39	29
3A4	49	39	6K8G	55	49	12Q7GT	45	39	75	50	39
3Q5	55	49	6L6G	79	69	12SA7GT/G	40	32	76	49	45
3S4	55	45	6L7	84	78	12SF7	35	32	77	35	27
3V4	79	69	6N4	49	38	12SG7	49	39	78	49	39
5U4G	50	40	6Q7GT	47	39	12S7/1634	43	37	80	40	38
5W4GT	39	34	6R7	55	45	12SJ7GT	55	49	83	52	48
5X4G	39	35	6R7GT	59	49	12SK7GT/G	45	35	83V	79	69
5Y3G	42	37	6SA7	49	39	12SL7	49	43	84/6Z4	49	39
5Y3GT/G	40	33	6SA7GT/G	44	37	12SQ7GT/G	40	32	85	49	45
5Y4G	39	32	6SB7	55	45	12SR7	35	32	89	49	46
5Z3	49	39	6SD7GT	39	34	14A7	65	55	99V	35	25
5Z4	59	49	6SF5	49	39	14B6	59	49	99X	35	25
6A6	69	61	6SG7	44	39	24A	49	39	117Z6GT/G	89	76
6A7	50	45	6SH7GT	40	32	25A6	69	59	182B	99	89
6A8GT	49	39	6SJ7GT	44	37	25L6GT/G	49	39	1231	39	29
6A87/1853	53	46	6SK7GT/G	49	39	25Z5	49	45	1644	29	19
6AC5	69	59	6SL7GT	49	47	26	45	32			
6AC7/1852	65	60	6SN7GT	49	47	27	49	44			
6AG7/6AK7	89	79	6SQ7GT/G	44	37	30	59	49			
6AH6	49	39	6SD7	49	39	32	80	75			
6AK5	74	69	6SS7	59	49						

SENCO RADIO INC. MINIMUM ORDER \$1.00

Dept. A, 73 West Broadway,
New York 7, N. Y.
TELEPHONE—BEEKMAN 3-6498

WHEN ORDERING—
Send 25% deposit for
all C.O.D. Shipments. Include sufficient postage—excess will be refunded.
Orders without postage will be shipped express collect. All prices F.O.B. New York City.

DIVIDEND OF THE MONTH

885

THYRATRON, TRIODE TYPE

SPECIAL

29¢ EACH

War Surplus Bargains Sold As Used Unless Otherwise Specified!

VOLUME CONTROLS PRICE

1 megohm, carbon, 1" shaft	\$.35
1000 ohms, carbon, screw-driver shaft	.35
20 ohms, wire-wound, 1" shaft	.35
500,000 ohms, carbon, 2" shaft	.35
1000 ohms, wire-wound, 2" shaft	.35
6000 ohms, with switch, carbon, 1" shaft	.40
Dual 25,000 ea., wire-wound, 1" shaft	.35
Triple 25,000-50,000-20,000, carbon, 1" shaft	.70

RESISTORS WIREWOUND

3 ohms, 20 watt	.10
2500 ohms, 20 watt	.10
1/2 ohm, 20 watt	.10
11269 ohms, 100 watt (has 5 taps)	.35

RESISTORS—CARBON

100 ohms, 1/2 watt	\$3.00 per hundred
120 ohms, 1/2 watt	3.00 per hundred
220 ohms, 1/4 watt	3.00 per hundred
270 ohms, 1 watt	3.00 per hundred
470 ohms, 1/4 watt	3.00 per hundred
480 ohms, 1/2 watt	3.00 per hundred
1200 ohms, 1/2 watt	3.00 per hundred
6800 ohms, 2 watt	3.00 per hundred
12,000 ohms, 2 watt	3.00 per hundred
21,000 ohms, 1/4 watt	3.00 per hundred
56,000 ohms, 1/4 watt	3.00 per hundred
85,000 ohms, 1/4 watt	3.00 per hundred
150,000 ohms, 1 watt	3.00 per hundred
270,000 ohms, 1/2 watt	3.00 per hundred
830,000 ohms, 1/4 watt	3.00 per hundred
1,200,000 ohms, 1/2 watt	3.00 per hundred
5,600,000 ohms, 1/4 watt	3.00 per hundred

CONDENSERS

	PRICE
.5 mfd. 600 V., Oil, 3/4" x 1 1/4" x 2"	\$.20
.5 mfd. 400 V., paper, 1" dia. x 2 1/4"	.25
5.2 mfd. 50 V., Chicago Ind. Cond. Corp., Oil, 1 x 2 1/2 x 3"	.25
4 mfd. 600 V., GE Pyranol, 1" x 2 1/2" x 3"	.50
2 mfd. 600 V., Aerovox Oil, 1" x 1" x 3 1/2"	1.25
8 mfd. 600 V., Chgo. Ind. Cond. Corp., Oil, 1" x 4" x 5"	1.50
1 mfd. 4000 V., C-D, Oil, 2" x 4" x 7"	4.00
.02 mfd. 600 V., mica	.05
4 mfd. 1000 V., Oil, C-D or Aerovox, 1" x 2" x 7"	2.50
30 mfd. 330 V. AC, GE pyranol	3.00
2 mfd. 1000 V., C-D, Oil, Single hole mounting, 1 1/2" dia. x 4 1/2"	1.75
4 mfd. 600 V., C-D, 1 1/2" x 4 1/2", single hole mounting	1.25
140 mfd., variable, padder screwdriver adjustable	.25
7-17 mmfd., variable tuning, 5 plate, 2" shaft, 1/4" dia.	.25
.1 mfd. 400 V., paper, Aerovox	.15
.14 mfd. 50 V., paper	.15
.1 mfd. 1500 V., paper	.20
.05 mfd. 400 V., paper	.15

LIP MICROPHONE

Made by Western Electric,
Navy type CW-51071, with
instruction sheet, brand new

PRICE \$1.50

Telephone LINCOLN 8328

PRICES F.O.B. INDIANAPOLIS

TERMS: CASH WITH ORDER

**AMERICAN SURPLUS
PRODUCTS CO.**

537 N. CAPITOL AVE.
INDIANAPOLIS, IND

TYPE 813 TUBES

\$5.95 each

Type 813 tube sockets

NEW PRICE 50c



NAVY CRV-46151 AIRCRAFT RADIO RECEIVER

Four bands including broadcast (195-9.050 KC). Circuit is six-tube superheterodyne with mechanical band change or remote operated electrical band change. Remote band change and tuning controls included, making this set readily adaptable to mobile ham use. Powered from self-contained 24 V. DC dynamotor.

The sets are complete with lights and remote controls. No cables or plugs. Including case

\$29.50

TURBO AMPLIFIERS



Used for ports—shipped complete with the following tubes;

- 2 7 C5's
- 1 7 Y4
- 1 7 F7

PRICE — Carton of 10 — \$7.50

WILLARD LEAD ACID CELLS

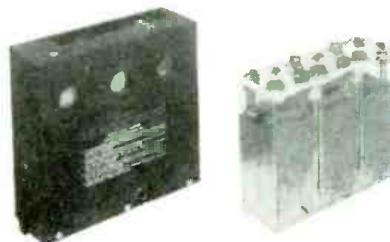

- 6 V. (New) (Dry-charged)..... \$3.00
- 6 V. (In metal carrying case) (Add electrolyte specific gravity 1.265) (Drugstore) \$4.00

BL-SELENIUM RECTIFIER TYPE 23751

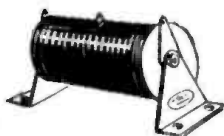

A must for the radio man for the much needed 110 V. DC source. 110-120 V. AC input, 110-135 V. DC output at .75 amp. Connect in parallel for highest current requirements. Size 3 3/8 x 2 5/8 x 1 3/4 inches.

PRICE—New..... **\$1.65 ea.**

REMOTE CONTROLLED COIN INSERT AND SPEAKER BOX

Made by Personal Music Corp., Newark, N. J.



CLOSED VIEW

Model F
24 Volt operated, fused
Weight 6 1/2 lbs.
Size 4 3/4 x 7 1/2 x 5 1/2" high
Sloping front
P. M. Speaker 5" size
Has 2 Pilot Lights for illumination
Finished in chrome metal and grill with red plastic
Accepts 1 to 6 nickels
Each 5c coin gives about two phono records of music
Should be mounted on a flat base
Has Haydon Mfg. Co. timer
Lock installed in top. (with key.)
Easily removable coin box, size 6" x 3 1/2" x 1 1/2"
Requires 4 wires from power unit
A beautiful piece of equipment that could be built to house coin operated radio
Worth several times our asking price. Price brand new... **\$4.95**

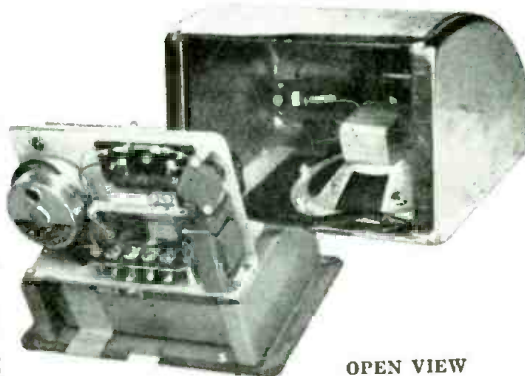

OPEN VIEW

PILOT'S CONTROL BOX, TYPE CRV-23254

Used with CRV-46151 Receiver for remote control of volume, selection of any one of six frequency bands, as off/on switch or selection of C.W. and M.C.W. and M.V.C. or A.V.C. Black crackle finish. Size 2"x2 1/2"x5" high.

Brand new **\$1.50 each**

ARGON BULBS

2 watt, 110 Volt, Edison base. Ideal for R.F. indication, night light.

Brand new, Box of ten **\$1.75**

RECEIVER TUNING HEAD CRV-23253

Used with CRV-46151 Receiver for vernier tuning. Has beveled dial with hairline cursor. Bands are 200560, 560-1600, 1600-4450, 4450-9050 Kcs. Each band spread over about 280 degrees of dial edge. Has provision for flexible tuning shaft or can be adapted for direct drive on any tuning shaft. Black crackle finish. Size 5"x3"x2" overall.

Brand new **\$1.50 each**

PHONE LINCOLN 8328

FIELD TELEPHONE WIRE

3 conductor, stranded, insulated and weather-proofed. Ideal for intercommunication systems, telephones, selsyn indicators. Use it inside or out of doors.

525 Foot roll, brand new, **\$4.25**

PRICES F.O.B. INDIANAPOLIS
TERMS: CASH WITH ORDER

AMERICAN SURPLUS PRODUCTS CO.

537 N. CAPITOL AVE.
INDIANAPOLIS, IND.

WESTINGHOUSE RECTIGON BATTERY CHARGER BULB

Style 289416, 6 ampere rating. For replacement in most chargers or for building power supply to use on D.C. operated equipment.

Brand new **\$1.90 each**

The Crystal Detector

Part IV—Circuits and Techniques Using Germanium Crystal Diodes

By JORDAN McQUAY

MODERN crystal rectifiers are adaptable to many practical uses. They can be valuable in almost any circuit where low-power rectification is required.

Most practical are the germanium types of crystal diodes which give superior performance at frequencies up to several hundred megacycles with low values of load resistance. Known as types

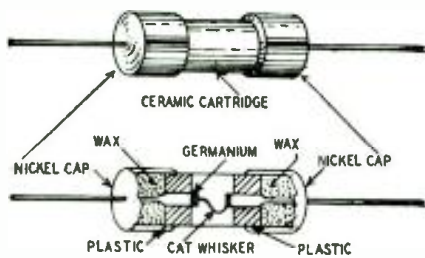

Fig. 1—Cutaway view of IN34, crystal diode having many radio and television applications.

1N34, 1N35, 1N38, and 1N39, they are fast becoming important circuit elements.

In addition to improving performance, germanium crystal diodes permit simplification of many radio, television, and electronic control circuits. They are suitable for use as second detectors and as d.c. restorers in television receivers, as modulators and demodulators, and as low-frequency oscillators, voltage regulators, and polarizing devices. Other applications include volume limiters and clamping circuits, square-wave clippers, radio testing instruments, meter rectifiers, volume expanders and compressors, rectifier bridges or varistors, and a variety of other functions.

Contained in tiny cartridges (Fig. 1), crystal rectifiers require no heater supply. They are affected less by temperature, humidity, and age than other types of dry rectifiers. They resist shock and vibration as well as or better than conventional vacuum tubes.

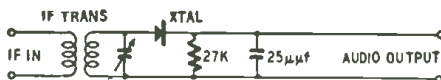

Fig. 2—Typical circuit of germanium diode as a half-wave detector in a superheterodyne.

Electrical features include small shunt capacitance (less than $1 \mu\text{f}$), low forward resistance, high back resistance, and the ability to work into a low resistive load with reasonable efficiency. The lack of a heater removes one common cause of noise and hum and permits connection of both ter-

minals well above ground potential when desired.

Another important characteristic of germanium crystal diodes is their remarkably long life. For instance, the type 1N34 is rated for service in excess of 5,000 continuous hours.

A few types of silicon crystal diodes, designed originally for microwave operation and obtainable through war surplus channels, can be used at lower frequencies. They must be operated at very low power and invariably suffer from reduced operational efficiency. Germanium crystals are desirable for most practical applications.

Crystal detectors

Using germanium crystal diodes to detect the i.f. output signal of conventional superheterodynes is satisfactory up to several hundred megacycles. At higher frequencies, silicon crystals are preferable.

A single crystal diode can be used as a half-wave detector as shown in Fig. 2. Full-wave rectification requires two crystal diodes (Fig. 3) of the same type, preferably with the same characteristics.

A.v.c. voltage can be supplied by a separate crystal diode arrangement, as shown in Fig. 4. Crystal A provides a negative voltage for a.v.c. action; crystal B functions as the second detector,

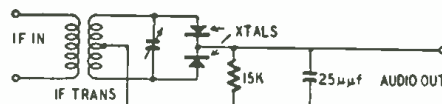

Fig. 3—Full-wave detector in superheterodyne set using two germanium crystal rectifiers.

but is connected with opposite polarity to that of crystal A to balance the load on the final i.f. stage of the receiver. Both crystals should be of the same type, but need not be perfectly matched.

Crystal diodes also are used in the second detector or discriminator stage of FM receivers, replacing the usual diode vacuum tubes. Since the discriminator has a balanced output, the two germanium crystal diodes used for full-wave rectification must have almost identical operating characteristics.

Ideal for this purpose is the type 1N35, consisting of two 1N34 diodes which are selected with great care at the time of manufacture so that their resistances are matched within 10% of their average value in the forward direction when measured at 1 volt. The reverse or blocking resistance must be

greater than 400,000 ohms for each crystal when measured at -10 volts.

FM receivers originally designed to operate only in the 42-50-mc band can be converted for reception in the 88-108-mc band with tubeless crystal converters now being marketed. These converters use germanium crystal diodes and require no power for operation. They are connected between the antenna and the input of old style receivers.

Television uses

Crystal diodes can perform at least two important functions in modern television receivers. They can be used for detection in the discriminator stage of the sound circuit and for low-power d.c. restoration of the picture signal.

Except for band-width requirements, the discriminator of a television set is similar to that of an FM receiver. For television, ± 25 -kc deviation is required; for FM, ± 75 kc.

A pair of matched type 1N35 germanium crystals is used for detecting television sound signals just as in FM receivers.

Crystal diodes are used in clamping circuits as d.c. restorers whenever the input voltage does not exceed the normal rating of the germanium rectifier. Type 1N34 is limited to approximately 60 volts; type 1N38 will accommodate voltages up to approximately 100 volts. For signals of greater amplitude, any number of additional crystal diodes (preferably of the same type) can be connected in series.

A typical clamping circuit is shown in Fig. 5. It uses a single crystal diode connected between the output of the final video amplifier and the grid input of the picture tube. Some form of d.c.

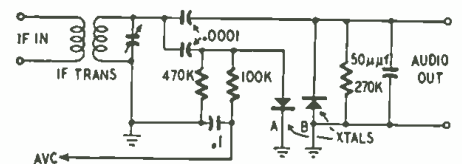

Fig. 4—Superheterodyne circuit using separate crystal diodes for detection and for a.v.c.

restoration is necessary at this point because a video amplifier is an a.c. amplifier and there is no d.c. component in the video output signal. The needed d.c. component represents the average illumination of the original scene, and, unless it is restored, proper scene illumination on the picture tube cannot be maintained.

The high back resistance of a germanium rectifier can be put to good use in many types of pulse-shaping circuits, since the crystal diode effectively supplies its own load resistance under most operating conditions. Thus, germanium diodes can also be used in electronic control devices. They offer a considerable advantage over any type of diode vacuum tube used in the same applications.

As a limiter, the crystal diode can be inserted in any circuit to remove undesired peaks. For example, when an electronic device requires a negative trigger pulse without positive overshoots, the undesired overshoots can easily be eliminated by connecting a crystal diode across the input of the trigger circuit.

Testing and servicing

Crystal diodes are very useful in radio and electronic maintenance.

A crystal diode can be used as the rectifying unit for a vacuum-tube voltmeter, permitting the compact construction of a practical, multipurpose a.f.-r.f. probe (Fig. 6).

Vacuum-tube voltmeters are essentially d.c. indicating devices, and require some kind of rectifier for a.c. measurements. Long leads introduce capacitive effects and are objectionable, and the rectifying unit should be installed in the test probe. A small diode vacuum tube could be used, but a germanium crystal is far more practical. It requires no power and is free from the contact potential effects normal to most diode vacuum tubes. The crystal is also smaller, making a more compact probe.

The maximum current rating of a crystal diode is considerably higher than that for diode vacuum tubes. Probes using crystal diodes have high input impedance and low capacitance, which reduce loading and detuning.

The frequency response of a germanium crystal diode is flat from zero to well over 100 mc, making it ideal for signal tracing and a.c. voltage measurements.

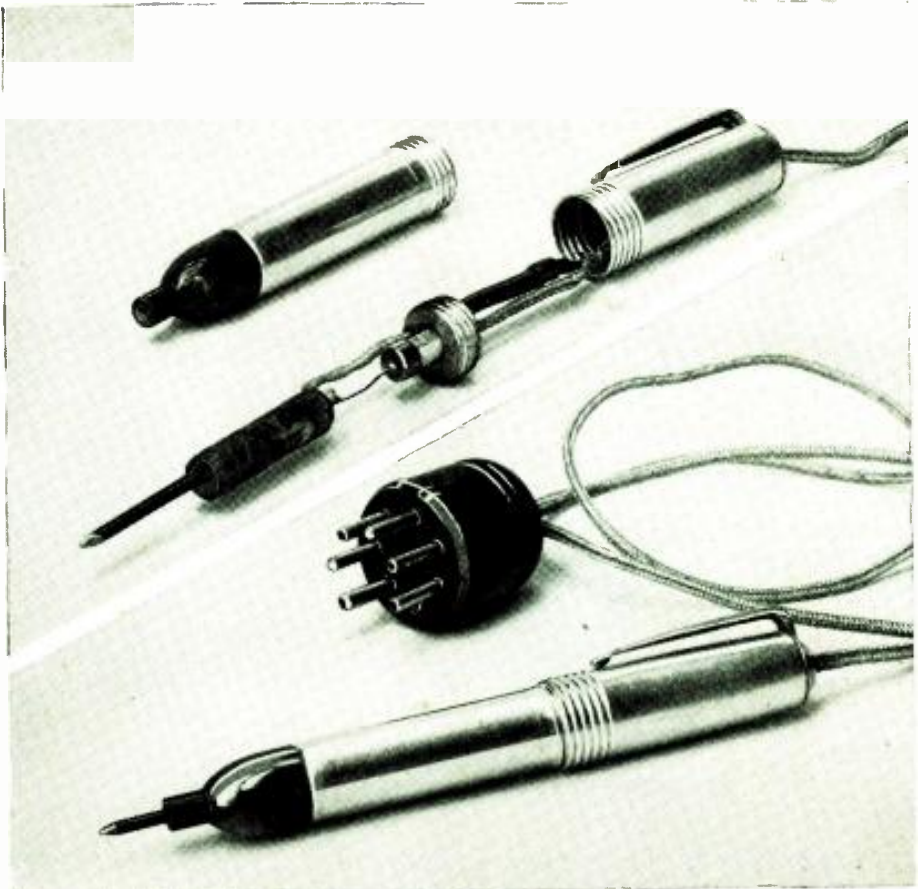

Fig. 6—Compact crystal probe for use with a v.t.v.m. is built in a small penlight case.

the apparatus being tested must also be grounded to the voltmeter by an additional wire and clip.

The single crystal diode employed in this circuit is adequate only for measuring signals of less than approximately 50 volts. To increase the voltage range of the probe, it is necessary only to connect a sufficient number of crystals in series across the input. Two 1N34's permit a.c. measurements up to about 100 volts.

When connected to high-resistance headphones, the probe can also be used for signal tracing, locating spurious oscillations or noise, and localizing distortion.

Crystal receivers

Inexpensive tubeless radio receivers can be constructed for local broadcast-band AM reception using any type of

being adjusted and fixed during manufacture for optimum operation.

Although lacking in both sensitivity and selectivity, these tubeless receivers provide fairly reliable local reception, with excellent fidelity.

Any of several circuits can be used. Fig. 8 shows a typical one. The tuning condenser has a maximum capacitance of 365 μ f.

The coil is wound on a cardboard or bakelite tube about 5 or 6 inches long with a diameter of 2 or 3 inches. Use No. 22 covered wire, and close-wind 90 to 140 turns on the coil form. Every 10 or 15 turns bring out a tap by twisting the wire, staggering the spacing so that a clip on the end of the antenna wire can be attached easily to any tap. Then scrape off the covering from each exposed tap to permit good contact.

The receiver will require a long antenna erected as high as possible and a good ground connection. Volume is varied by changing the tap to which the antenna clip is attached. No battery or other power source is necessary.

Ham applications

A simple device for determining the field strength or radiation pattern of a ham transmitter can be constructed around the crystal rectifier, requiring only a resonant dipole and a microammeter. These components are connected in what is effectively a closed series circuit (Fig. 9).

Since only relative readings are usual
(Continued on page 70)

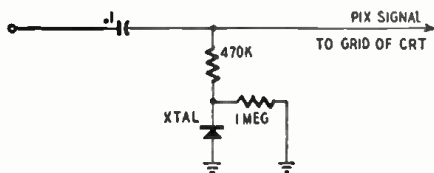

Fig. 5—Crystal diode used as clamper for d.c. restoration in video stage of a TV receiver.

A basic circuit for a crystal is shown in Fig. 7. The capacitor is used to isolate the probe from d.c. components present in the circuit being investigated.

The entire probe may be built into a small penlight flashlight case. One side of the capacitor is soldered to a short length of sharpened No. 8 wire; the other side is connected to the mounted crystal. A flexible shielded lead is used to connect the rectified output to the input of the vacuum-tube voltmeter or signal tracer. The frame of the penlight case must be grounded to the voltmeter via the wire shielding. The chassis of

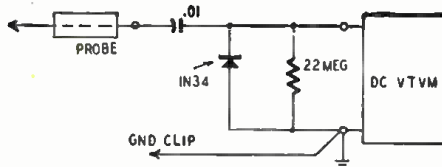

Fig. 7—Crystal probe circuit. Omit the 22-meg resistor if the v.t.v.m. has an internal shunt.

crystal diode as a detector. Here is a modern parallel to the crystal-and-cat-whisker era of the early days of radio. But the problem of finding the most sensitive spot on the detecting crystal is now eliminated, modern crystal diodes

locksmiting and key making

PRACTICAL UP-TO-DATE COURSE

How to pick locks, de-code, make master-keys, install, service, etc. New self-instruction lessons for every handyman, home-owner, carpenter, mechanic, service station operator, fix-it shop, hardware dealer, gunsmith, cycle shop. Good steady money-making trade!



53 EASY ILLUSTRATED LESSONS
Full price only \$3.95, nothing more to pay. Satisfaction or your money back. Fill in coupon at bottom of page and mail today.

NELSON-HALL CO.
1139 S. Wabash Ave., Chicago 5, Ill.

watch and clock repairing

LEARN AT HOME— IN YOUR SPARE TIME

Prepare now for a happy future of prosperity, security. Fascinating high-grade occupation for men of almost any age or physical condition. You can earn while you learn.

PRACTICAL COURSE IN HOROL- OGY. How-to-do-it lessons for beginners as well as those already in the trade. Thorough self-instruction training in American and Swiss watches, clocks. Contains a wealth of helpful photos, drawings, diagrams, charts, etc. Only \$4.95 for everything, complete. Satisfaction or refund guaranteed. Mail no-risk coupon below.

practical RADIO servicing

SELF-INSTRUCTION COURSE

Teaches you the practical side of radio repair, adjustment, operation, alteration, trouble-shooting. No previous knowledge necessary. Prepare to set up a shop of your own or train for the big industrial electronics field. Simplified lessons, including mathematics, review questions, problems, answers. Up-to-date! Only \$3.95, complete. Money-back guarantee. Use coupon below.



REAL ESTATE BUSINESS

The foundation of all wealth is land! Train yourself for a career in this booming profession. Here is the information you need on how to get started and how to get ahead in real estate. Includes instructions in appraisals, valuations, management, investments, practical real estate operating, low cost housing, the law on real estate including legal forms, etc., salesmanship, and many other subjects a successful real estate man must know. Strictly up-to-date. Complete, only \$6.95. Money-back guarantee. Use No-Risk coupon below.

Short-Cut Mathematics
COMBINED WITH
Practical Mechanics Simplified

Be a "master mind." Learn how to juggle figures, do baffling tricks with numbers. Add long columns of figures this lightning-quick, short-cut way. Multiply 4 figures by 4 figures without old-fashioned multiplication. Here are speedy, simplified systems used by stage "wizards," expert accountants, engineers. Only \$1.49. Course includes illustrations, problems, answers. Mail coupon below!

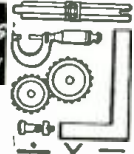

COMPLETE BLUEPRINT READING COURSE

Interesting, simplified self-instruction lessons for builders, mechanics, electricians, plumbers, welders, carpenters, automotive & aviation workers, etc. 24 volumes include over 600 actual blueprints, diagrams, other instructive step-by-step pictures. Unusual bargain for any practical man. Complete, only \$6.95, postpaid. Satisfaction or refund. Coupon below.

BUILD IT YOURSELF

Be a Practical handyman. Save time and money with these professional Trade-of-the-Trade. Carpentry made easy! New self-instruction course in one handy volume, complete with full page photographs, diagrams, etc. Teaches woodworking, painting & decorating, upholstering, power tools, cabinet making, etc. Full price only \$1.98. Money-back Guarantee. Mail coupon today!



Mail This No-Risk Coupon—Quick Action!

NELSON-HALL Co.,
1139 S. Wabash Ave., Dept. K-39, Chicago 5, Ill.

Please rush me the items I am checking below. It is understood that if I am not 100% satisfied I will send the material back within 10 days and you will make full immediate refund, without question or quibble.

- Watch & Clock Repairing.....\$4.95
- Locksmithing & Key Making..... 3.95
- Practical Radio Servicing..... 3.95
- Real Estate Business..... 6.95
- Short-Cut Mathematics..... 1.49
- Blueprint Reading Course..... 6.95
- Build It Yourself..... 1.98
- Apartment House Management..... 5.95
- Jewelers' Encyclopedia..... 1.69
- How to Sell Life Insurance..... 6.95
- Complete Shorthand Course..... 4.95

I enclose \$..... in full payment. Ship postpaid.
 Ship COD for \$..... plus postage and COD charges.

Name.....
Address.....

THE CRYSTAL DETECTOR

(Continued from page 69)

ly desired, accurate calibration is unnecessary. The crystal diode and the receiving dipole must be mounted rigidly in a fixed position with respect to each other. During field measurements, the crystal must not be jarred or shaken.

In the vicinity of very-high-power transmitters, it may be necessary to insert a small limiting resistor R (1 to 10 ohms) in the series circuit to obtain on-scale readings.

Using a stub dipole of appropriate size, the same crystal-microammeter arrangement can be used to explore the electric field distribution inside cavity resonators and wave guides.

If a pick-up coil is substituted for the resonant dipole, the arrangement can be used to indicate resonance in u.h.f. oscillator stages and transmission

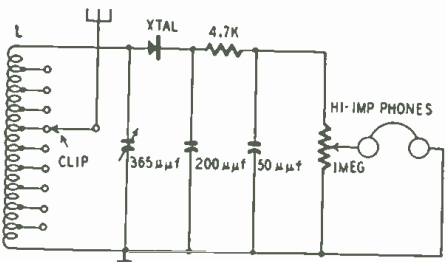

Fig. 6—Germanium crystal receiver for local broadcasts. The fixed crystal simplifies tuning.

circuits. The pick-up coil should have enough turns to insure on-scale meter readings; usually two or three turns are adequate. When used with high-power equipment, it may be necessary again to insert the limiting resistor R in series with the microammeter.

Crystal diodes can be used in place of diode vacuum tubes or other unilateral or nonlinear components in frequency meters, modulation meters, and other indicating devices. Other functions of crystal diodes—such as limiting, clamping, and voltage regulation—often can be applied to amateur rigs. Crystal rectifiers are particularly useful in port-

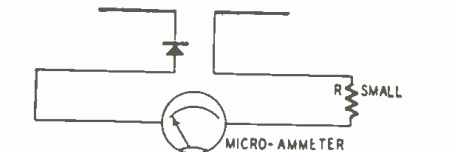

Fig. 9—Crystal rectifier circuit for measuring the field strength of the amateur transmitter.

able or mobile work since they require no power for operation.

Its characteristic relatively high back conductance upon breakdown makes the crystal diode useful as a voltage regulator, and excellent voltage control can be maintained with none of the disadvantages of gas-discharging tubes. The crystal is most effective when used to regulate voltages between 20 and 60 volts.

The crystal is connected, with a limiting resistor R, in a simple control cir-

cuit (Fig. 10). The value of R varies considerably, depending upon the magnitudes of the voltage and current. Any type of germanium diode is capable of handling an average current up to about 40 ma with a transient surge current, for some types, of 500 ma.

An important advantage of crystal diodes when used as voltage regulators is their ability to return to normal after the application of excessive voltages.

When four crystal diodes of the same type are arranged in a bridge network (Fig. 11), the circuit functions as a very effective voltage rectifier. Action of the bridge network is conventional. It accepts waves of any shape as long as the voltage does not exceed the rating of the germanium diode employed. In this case the network of four type-1N34 diodes accepts any wave form not exceeding 10 volts peak-to-peak value.

One important advantage in using crystals for bridge rectification is that the conducting resistance is much lower than when using vacuum tubes or any other unilateral devices. When a bridge network is used in connection with a.g.c. or impulse circuits, reflex action is much faster with crystal diodes than with any other type of rectifying element.

Crystal-diode bridge networks can be utilized to a great extent in ring modulators, carrier-suppression modulators, and similar modulation systems.

Such networks impose strict requirements on the four germanium crystals. The diodes must be selected with great care; their resistance (in the forward direction) must be balanced within 2.5% when measured at 1.5 volts, and in addition, the forward resistances of

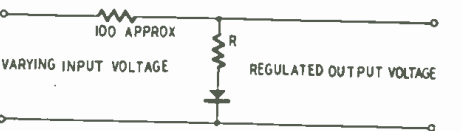

Fig. 10—Voltage regulator circuit. Germanium crystal is used. R is the limiting resistance.

each pair of crystal diodes must be matched within 1.5 ohms.

This is a long and costly procedure for the average user of crystal diodes. It led to the development of the varistor, a single unit enclosed in a metal tube envelope, containing a complete bridge

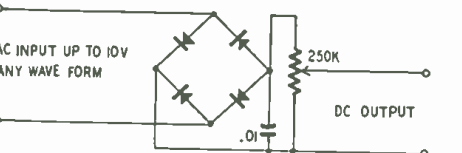

Fig. 11—Germanium crystals in bridge rectifier. Low conducting resistance is its feature.

network of four germanium diodes, matched and balanced at the time of manufacture. The varistor is extremely versatile and destined for wide use in a variety of future modulation and demodulation circuits.



NO NEED FOR

CONFUSION

Correspondence from service technicians and distributors suggests that many may be confused by the question, "What instruments do I really need to service TV and FM receivers?"

THERE IS NO NEED FOR CONFUSION! The answers are simple and direct . . . the new service techniques easy to master when pictorially presented. Only one new instrument must be added — some older instruments be replaced with new models for efficient and profitable TV and FM servicing.

THE ONE NEW INSTRUMENT needed is Model 911, a wide-range sweep generator for visual alignment. If you get the one the set makers themselves seem to favor you are naturally best equipped. Equally important, 911 comes to you with *new pictorial instructions*. Specially



**MODEL 911
TV/FM SWEEP GENERATOR.**

2 thru 226 mc.; electronic sweep adjustable 0 to 10 mc.; high output adjustable 0 to ½ volt. Separate 1 mc. and 5 mc. precision crystal marker oscillators to insure correct TV video i.f. curve shape and width; phasing control and 60~ sine-wave 'scope TV sweep voltage; 120~ saw-tooth FM 'scope sweep voltage. All this, yet only \$78.50 net.

designed for efficient TV and FM servicing, the new Silver Model 911 Sweep Generator takes all confusion out of TV and FM alignment.

REPLACEMENT OF OBSOLETE instruments with the new "VOMAX", the famous 906 FM-AM Signal Generator, adding new "SPARX" AM, FM, TV Signal Tracer, will really pay off in TV-FM service profits.



MODEL 900-A "VOMAX". The new "VOMAX" is the truly universal v.t.v.m. — makes TV, FM and AM measurements accurately — at highest meter resistance. Giant meter, non-breakable glass; 45 ranges; new single probe for a.c., d.c., a.f., r.f., volts, ohms, db. and current measurements. Advancing far beyond its predecessor, the overwhelming choice of experts, "VOMAX" equips you with the world's newest and finest meter for only \$68.50 net.



MODEL 906 FM-AM SIGNAL GENERATOR. Similarly the choice of the big engineering laboratories plus thousands of service technicians, 906 stands out as maximum value. 90 kc. thru 210 mc. in 8 ranges, $\pm 1\%$ accuracy; less than ½ microvolt, including strays to over 1 volt v.t.v.m.-metered output; multiple shielding; adjustable 0 to 100% amplitude modulation; adjustable 0 to 1,000 kc. FM sweep. Net price only \$116.50.

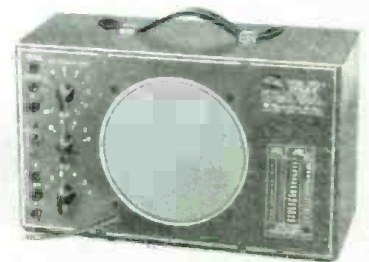

MODEL 905-A "SPARX". Combining signal-tracer and universal test speaker, 905-A is amazingly sensitive yet free of usual tracer hum. Vacuum-tube prod with r.f.-a.f. switching; high-gain high-fidelity amplifier; 6" PM speaker; 18-watt output transformer gives wide choice of impedances. Two essential instruments in one, 905-A is the finest 37 years of prize-winning radio engineering experience can design — value far exceeding \$44.50 net.

OVER 37 YEARS OF RADIO ENGINEERING ACHIEVEMENT

McMurdo Silver Co., Inc.

EXECUTIVE OFFICES: 1240 MAIN ST., HARTFORD 3, CONN.
FACTORY OFFICE: 1249 MAIN ST., HARTFORD 3, CONN.

Mail postcard for new catalog of LCETI — Laboratory Caliber Electronic Test Instruments . . . quality and prices which amaze even the experts.

RADIOMEN'S HEADQUARTERS * WORLD WIDE MAIL ORDER SERVICE !!

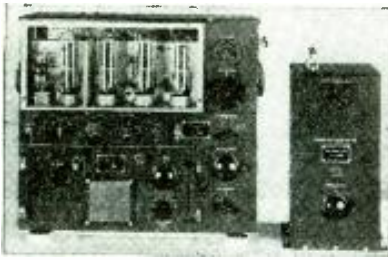

GENERAL ELECTRIC 150 WATT TRANSMITTER
Cost the Government \$1800.00 • Cost to You—BRAND NEW—\$67.50

This is the famous transmitter used in U.S. Army bombers and ground stations, during the war. Its design and construction have been proved in service, under all kinds of conditions, all over the world. The entire frequency range is covered by means of plug tuning units which are included. Each tuning unit contains its own oscillator and power amplifier coils and condensers, and antenna tuning circuit—all designed to operate at top efficiency within its particular frequency range. Transmitter and accessories are finished in black crackle, and the milliammeter, volt-500 KC and 1500 to 12,500 KC. (Will operate on 11 and 20 meter band with slight modification for which diagrams are furnished). **OSCILLATOR:** Self-excited, thermally compensated, and the milliammeter, volt-500 KC and 1500 to 12,500 KC. (Will operate on 11 and 20 meter band with slight modification for which diagrams are furnished). **POWER AMPLIFIER:** Neutralized class "C" stage, using 211 tube and equipped with antenna coupling circuit which matches practically any length antenna. **MODULATOR:** Class "B" uses two 211 tubes. **POWER SUPPLY:** Supplied complete with dynamotor which furnishes 100V at 350 MA. from either 12 or 24 volts. Complete instructions are furnished to operate set from 110V AC. **SIZE 21 1/2 x 23 x 9 1/2".** Total shipping wt. 300 lbs. complete with all tubes, dynamotor power supply, seven tuning units, antenna tuning unit and the essential plugs. **NOTE:** Price increases to \$100.00 effective Oct. 1, 1948.

GENERAL ELECTRIC RT-1248 15-TUBE TRANSMITTER-RECEIVER

TERRIFIC POWER—(20 watts) on any two instantly selected, easily pre-adjusted frequencies from 435 to 600 Mc. Transmitter uses 5 tubes including Western Electric 316 A as final. Receiver uses 10 tubes including 935's, an first detector and oscillator, and 3-7H7's as IF's with 4 slug-tuned 40 Mc. IF transformer, plus a 7H7, 7E6's and 77's. In addition unit contains 8 relays designed to operate any sort of external equipment when actuated by a received signal from a similar set elsewhere. Originally designed for 12 volt operation, power supply is not included, as it is a cinch for any experimenter to connect this unit for 110 AC, using any supply capable of 400 DC at 435 MA. The ideal unit for use in mobile or stationary service in the Citizen's Radio Telephone Band where no license is necessary. Instructions and diagrams supplied for running the RT-1248 transmitter on either code or voice in AM or FM transmission or reception, for use as a mobile public address system, on 80 to 110 Mc. as an FM broadcast receiver, as a Facsimile transmitter or receiver, as an Amateur Television transmitter or receiver for remote control relay pickups, for Griger-Mueller counter applications. It sells for only \$29.95 or two for \$53.90. If desired for marine or mobile use the dynamotor which will work on either 12 or 24V DC and supply all power for the set is only \$15.00 additional.

BRAND NEW BC-221 FREQUENCY METERS

with calibrating Crystal and calibration charts. A precision frequency standard that is useful for innumerable applications for laboratory technician, service man, amateur, and experimenter at the give away price of only \$75.00.

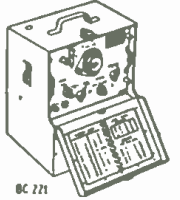

1949 MODEL MUTUAL CONDUCTANCE TUBE TESTER with new 9 pin socket to handle all future tube developments. **\$49.95**
 No possibility of good tubes reading "Bad" or bad tubes reading "Good" as on dynamic conductance testers or other ordinary emission testers. Attractive panel and case equal to any on the market in appearance. Large 4 1/2" micromho scale as well as a Bad-Good scale. Front panel fuse. Individual sockets for all tube base types—voltages from .75 volts to 117 volts and complete switching flexibility allow all present and future tubes to be tested regardless of location of elements on tube base. Indicates gas content and detects shorts or opens on each individual section of all local, octal and miniature tubes including cold cathode, magic eye and voltage regulator tubes as well as all ballast resistors. Name of the nationally known reading "Good" as on dynamic conductance testers or other Model "P"—Sloping front counter case. **\$49.95**
 Model "M"—Handsome hand-rubbed portable case. **\$4.95**
 Built-in roll chart with either of above \$5.00 extra.

RT1711 Brand New 12 Tube, 110 Volt Receiver-Indicator-Oscilloscope complete with all tubes and power supply. Has telescoping hood over scope tubes, which is equipped with a detachable calibrated screen. Has centering and amplitude controls and two video inputs. A natural for television. **\$39.95**

SELENIUM RECTIFIERS. All types are rated at 130 V.A.C. Do not assort to make quantity.

75 MA 70	10 for 6.50	50 for \$31.00
100 MA 75	10 for 7.00	50 for 32.50
150 MA 80	10 for 7.50	50 for 35.00
200 MA 1.05	10 for 10.00	50 for 47.50
250 MA 1.25	10 for 12.00	50 for 57.50

TERRIFIC VALUE—PORTABLE ELECTRIC DRILL

(Sold at less than established factory price so we cannot mention brand name.)
 Only \$19.95 equipped with 1/2" Jacobs Geared Chuck and Key. Not an intermittent duty drill, but a full size rugged tool. Most convenient type switch, natural grip handle, and balance like a six-shooter. Precision cut gears—turbine type cooling blower—extra long brushes. No stalling under heaviest pressure because of powerful 110 Volt AC-DC motor and multiple ball thrust bearing. Other bearings self-aligning lifetime-lubricating Chrysler Oilite type. Made for toughest year-in and year-out service in Plant or on construction jobs. Amazing post-purchase factory guarantee assures you of a lifetime of trouble-free use. 25% deposit on C.O.D.'s. Full refund if returned prepaid within five days.



HEAT GUN



Streamlined pistol grip heat gun in vivid red housing, that delivers a powerful 20 Cubic Ft per minute blast of hot air at 160 Fahrenheit. Ordinary blowers have small fan motors, but this has a lifetime lubricated AC-DC motor of the rugged vacuum cleaner type, that produces a hurricane of either hot or cold air. Perfect for blowing out dirt or dust from radio chassis, drying out ignition systems, warming up carburetors, quick-drying paint, thawing out radiators or water pipes, etc. Warning—Keep this away from your wife, or she will be using it to dry her hair because it will do it in half the time of her ordinary hair dryer. Make for toughest year-in and year-out service in Plant or on construction jobs. Amazing post-purchase factory guarantee assures you of a lifetime of trouble-free use. 25% deposit on C.O.D.'s. Full refund if returned prepaid within five days.

CONDENSERS—PAPER TUBULAR 100 WV.—001, 002, 005—8c; .01, .05—9c; .1c—2c; .2c—23c; .45 35c; **ELECTROLYTICS:** 2mf 200—20c; 1mf 35—20c; 5mf 150—23c; 20/20mf 150—35c; 30/20 150—46c; 5mf 150—43c; 8mf 475—34c; 16mf 350—55c; **OIL CONDENSERS:** 4mf 600v 49c; 2mf 600v—29c; 5X 1mf 600v—29c.

SPEAKERS These 12M speakers are the finest that are available. All have heavy oversize Alnico V magnets.

3 1/2" \$1.15	6 for \$6.60
4" \$1.15	6 for \$6.60
5" \$1.10	10 for \$9.50
6" \$1.50	6 for \$8.70
7" (Car Radio Size) \$4.50	6 for \$21.50
8" 21 oz. \$3.95	6 for \$20.50
8" 21 oz. \$4.95	6 for \$26.50
10" 21 oz. \$5.50	6 for \$30.00
12" 21 oz. \$7.95	6 for \$42.00

\$5.95 Takes Both BIG BARGAINS

1. **ALUMINUM GEAR BOX 144587** that contains two powerful electric motors and two matched gear trains, 62 gears in all varying in size from 1/2 to 4 inches in diameter. This unit is readily converted to rotate a beam antenna or any other similar use. **\$3.00**
 2. **SENSATIONAL FASCINATING, AMAZING SELSYNS:** Brand new selsyns made by G. E. Co. Two or more connected together work perfectly on 110 VAC. Any rotation of the shaft of one selsyn and all others connected to it will rotate exactly as many degrees in the same direction, following instantly as if the units were connected together by shafting instead of wires. This is true whether you twist the shaft of the motor into a fraction of a revolution or many revolutions. Useful for indicating the direction of weather vanes, rotating directional antennas, or controlling innumerable operations from a distance. Complete with diagram and instructions. Per matched pair. **\$4.95**

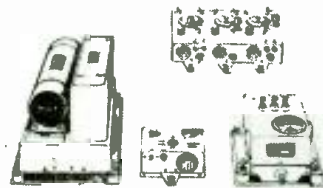

SCR-274N COMMAND SET

The greatest radio equipment value in history. A mountain of valuable equipment that includes 3 receivers that use plug-in coils, and consequently can be changed to any frequencies desired without conversion. Also included are two Tuning Control Boxes; 1 Antenna Coupling Box; four 28V. Dynamotors (easily converted to 110V. operation); two 40-Watt Transmitters including crystals, and Pre-amplifier and Modulator. 29 tubes supplied in all. Only a limited quantity available, so get your order in fast. Removed from unused aircraft and in guaranteed electrical condition. A super value at \$34.95, including crank type tuning knobs for receivers.

PE-109 32-Volt Direct Current Power Plant

This power plant consists of a gasoline engine that is direct coupled to a 2000 watt 32 volt DC generator. This unit is ideal for use in locations that are not serviced by commercial power or to run many of the surplus items that require 21-32V DC for operation. The price of this power plant is only \$79.95. We can also supply a converter that will supply 110v AC from the above unit or from any 32V DC source for \$12.95.

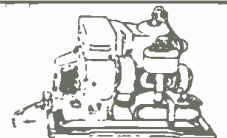

NOTE: Each of the PE-109 power plants that we sell has been actually run and tested for output by us before shipment. Above price is FOB Buffalo.

Cable Address: BUFRAD

BUFFALO RADIO SUPPLY, 219-221 Genesee St., Dept. RC-10 BUFFALO 3, N. Y.

RADIO-ELECTRONICS for

RADIOMEN'S HEADQUARTERS + WORLD WIDE MAIL ORDER SERVICE !!

BUFFALO RADIO SUPPLY, ONE OF AMERICA'S LARGEST ELECTRONIC DISTRIBUTORS, IS IN A POSITION TO SUPPLY MOST OF THE REQUIREMENTS OF FOREIGN PURCHASERS, DIRECTLY FROM ITS GIGANTIC STOCKS OR THOSE OF ITS AFFILIATES. EXPORT INQUIRIES ARE SOLICITED BOTH FROM EXPORT HOUSES AND FROM FOREIGN GOVT. PURCHASING COMMISSIONS HERE AND ABROAD. EXPENSE CAN BE REDUCED AND REQUIREMENTS FILLED WITH A MINIMUM OF DELAY BY CONTACTING BUFFALO RADIO SUPPLY INITIALLY.

SOS EMERGENCY TRANSMITTER SOS

This is the famous Gibson Girl Transmitter that saved so many lives during the war. It is used as a distress call transmitter on boats and airplanes. The Gibson Girl is the easiest transmitter in the world to operate. No instruction or experience necessary. No external power supply required for operation. It is merely necessary to turn the crank on the top of the transmitter and power is generated and the distress signal is automatically sent out on the international distress frequency. Brand New Gibson Girl Transmitter complete with tubes.....\$9.95

Antenna Kit for Gibson Girl transmitter. This kit was designed to improve the effectiveness of the Gibson Girl Transmitter by increasing the range several times. The kit includes 300 feet of special antenna wire, two balloons for raising the antenna in calm weather, two hydrogen generators to inflate the balloons, a special box kite for antenna erection in windy weather, and a searchlight, powered by the crank operated generator in the transmitter. Complete kit.....\$9.95

BUFRAD CAR RADIO ANTENNAS

All of our car radio antennas are made of triple plated Admiralty Brass Tubing, complete with low loss shielded antenna leads and high quality fittings.
SIDE COWL—BR-1, 3 sections extend to 66". Your price—single units—\$1.50; in lots of 12—\$1.35 ea.
SKYSCRAPER—BR-2 has 4 heavy duty sections that extend 98". This super-aerial must be seen to be fully appreciated. Your price—single units—\$2.45; in lots of 12—\$2.25 ea.
TILT ANGLE—BR-3, may be adjusted to all body contours, 3 sections extend to 66". Single unit price—\$1.50; 12 lot price—\$1.25 ea.
VERSATILE—BR-4, single hole fender or top cowl mounting may be adjusted to conform with all body contours, 4 sections extend to 56". Single unit price—\$2.90; 12 lot price—\$2.75 ea.
THE MONARCH—BR-5, single hole top cowl mounting, 3 sections extend to 56". Single unit price—\$1.90; 12 lot price—\$1.75 ea.



AFTER SEEING OUR ANTENNAS AND COMPARING, YOU WILL NEVER BUY ANY OTHER MAKE!

COMPRESSED AIR INSTANTLY, Anywhere!!



Portable Air Compressor and storage tank. Incredibly built of best materials using lifetime lubricated ball-bearing on connecting rod and oil impregnated main bearing on shaft. Unusual design forever eliminates valve trouble, the most common fault in all compressors. PATENTED unique air intake system increases efficiency tremendously over other compressors so that air output is much greater than that from larger compressors powered by heavier motors. Will deliver approximately 3500 cu. inches of air per minute at maintained pressure of 30 lbs., or will inflate a 90 ft. truck tire in less than one minute. Comes complete with 100 lb. gauge, although finger tip adjustment allows setting of output pressure at any value, which will automatically be maintained. Works from any 1/4 H.P. motor. Useful for spraying paints or lacquers, disinfectants, insecticides, annealing or brazing with natural gas, inflating tires, etc. Price \$14.50 postage prepaid anywhere in the U. S. Efficient, complete with 12 ft. of 100 lb. tested type spray gun, complete with 12 ft. of 100 lb. tested hose available for only \$7.75 with pint container, also prepaid, 25% required on all C.O.D. orders. Send for free catalogs of radio parts and surplus items.

- AUTO TRANSFORMERS**—Steps up 110v, or steps down 220v to 110v—\$1.95.
FILE TRANSFORMER—6.3v, 20 Amps.—\$1.98; Universal Output Trans.—8 Watt—89c; 18 Watt—\$1.29; 30 Watt—\$1.69. **AUDIO TRANSFORMERS**—S. Plate to S. Grid, 3:1—79c; S. Plate to P.P. Grids—79c; Heavy Duty Class AB or B. P.P. inputs—\$1.49; Midset output for AC-DC sets—69c. **WAKE TRANSFORMER** for T-17 Shure microphone, similar to UTC guncoder type—\$2.00. Stancor SR or DR nickel to line or add—\$1.95.
POWER TRANSFORMERS—Half-shell type, 110V, 60 cy. Center-tapped HV winding. Specify either 2.5 or 6.3V filament when ordering.
 For 4-5 tube sets—650V, 40MA, 5V & 2.5 or 6.3V.....\$1.49
 For 5-6 tube sets—650V, 45MA, 5V & 2.5 or 6.3V.....1.75
 For 6-7 tube sets—675V, 50MA, 5V & 2.5 or 6.3V.....1.90
 For 7-8 tube sets—700V, 70MA, 5V & 6.3 or two 2.5V.....2.35
 For 7-8 tube sets—700V, 70MA, 5V & 6.3 12: Cycle.....3.60
 For 8-9 tube sets—700V, 90MA, 5V-3A, 2.5V-3.5A, 2.5-10.5A.....2.85
 For 9-11 tube sets—700V, 5V & 6.3V-4A.....2.85
 For 9-15 tube sets—600V, 150MA, 5V & 6.3V.....2.95

BENDIX SCR 522—Very high Frequency Voice Transmitter-Receiver—100 to 156 MC. This job was good enough for the Joint Command to make it standard equipment in everything that flew, even though each set cost the Gov't \$2500.00. Crystal Controlled and Amplitude Modulated—HIGH TRANSMITTER OUTPUT and 3 Microvolt Receiver Sensitivity gave good communication up to 180 miles at high altitudes. Receiver has ten tubes and transmitter has seven tubes, including two 832's. Furnished complete with 17 tubes, remote control unit, 4 crystals, and the special wide band VHF antenna that was designed for this set. These sets have been removed from unused aircraft and are guaranteed to be in perfect condition. We include free parts and diagrams for the conversion to "continuously variable frequency coverage" in the receiver. The SCR 522 complete with 24 volt dynamotor sells for only \$37.95. The SCR 522 is also available with a brand new 12 volt dynamotor for only \$42.95.

STEATITE VARIABLE CONDENSERS

Ideal for high-frequency applications in receivers and low power transmitter stages.

STANDARD 1/4" DIA. SHAFTS		SCREW DRIVER ADJUSTMENT	
10 mmf	\$3.50-10 for \$2.90-100 for \$23.00	\$20-10 for \$1.80-100 for \$16.00	
15 mmf	\$3.50-10 for \$2.90-100 for \$23.00	\$20-10 for \$1.80-100 for \$16.00	
25 mmf	\$3.50-10 for \$2.90-100 for \$23.00	\$20-10 for \$1.80-100 for \$16.00	
35 mmf	\$4.00-10 for \$3.40-100 for \$28.00	\$20-10 for \$1.80-100 for \$16.00	
50 mmf	\$4.50-10 for \$3.70-100 for \$30.00	\$25-10 for \$2.30-100 for \$20.00	
75 mmf	\$5.00-10 for \$4.10-100 for \$38.00	\$25-10 for \$2.30-100 for \$20.00	
100 mmf	\$5.50-10 for \$4.50-100 for \$39.00	\$30-10 for \$2.70-100 for \$25.00	
140 mmf	\$8.00-10 for \$7.40-100 for \$64.00	\$30-10 for \$2.70-100 for \$25.00	
160 mmf	\$1.00-10 for \$8.50-100 for \$70.00	\$40-10 for \$3.60-100 for \$32.00	
140-140 mmf	\$1.60-10 for \$12.50-100 for \$100.00		

Butterfly condensers, rotor has two ball bearings and a 3/8" shaft.
 15 mmf. per section \$5.50-10 for \$4.50-100 for \$30.00
 30 mmf. per section \$6.00-10 for \$5.50-100 for \$50.00
 50 mmf. per section \$7.00-10 for \$6.50-100 for \$60.00

Manufacturers and distributors write for prices on larger quantities. WE HAVE OVER 250,000 VARIABLE CONDENSERS IN STOCK.

- FILTER CHOKES**: 200, 300, 400, 500 ohm light duty—59c; 200 or 300 ohm heavy duty—99c; 250 ma 35 ohm, made for U.S. Navy, fully shielded—\$1.95. 75 ohm 125 ma—25c; or 25 for \$4.25. "Wobler" type tapped filter chokes—25c; choke-condenser combination, ideal to replace any size speaker field when installing PM speaker—79c.
SPLATTER CHOKES—These Tapped "SPLATTER CHOKES" are used between Class C stage and Modulator to eliminate objectionable side band splatter. DC resistance 50 ohms. Our part No. 860—\$1.50.
SELENIUM RECTIFIERS—Dry disc types 1 1/2", 1", 1/2" Amp. maximum, suitable for converting DC relays to AC, for supplying filament source in portable radios, converting DC meters to AC applications, and also may be used in low current chargers—90c.
30 MC IF TRANSFORMERS, double slug tuned—25c.
30 MC VIDEO AMPLIFIER PLATE COILS—Single tuned—25c.

RT-1579 consists of a three stage, cascade 6SJ7's and 6F6 output stage high gain, high fidelity amplifier with 60 cycle, 110V power supply on the same 13 1/2x 1 1/2 chassis, which is protected by a substantial steel cover over tubes and parts. Made by Western Electric with typical quality components such as a husky power transformer and oil condensers, this unit is obviously intended to give years of trouble-free service with no more need for repairs than a telephone. Disconnecting one wire each, from the special input and output filters, will result in as high a fidelity amplifier as can be obtained. Your cost with tubes, diagram and parts list included—\$14.95.

RT-1655—11 tube crystal controlled superhet receiver for 34-28V DC operation. Beautiful chassis and cabinet. Uses latest tube types including 7 miniature 6AJ5's. Tubes and schematic supplied. Only a few available at.....\$14.95

SOLDER

KESTER ROSIN CORE SOLDER of NAVY instrument grade in 1/16" diameter. Made from virgin lead and tin and water-white rosin to the highest possible specifications, and guaranteed to contain at least 40% pure tin. You know how you cursed wartime solder that turned to mud on your iron in a minute. This solder will stay bright and clean on your iron longer than any you have previously used. Have your own stockpile against possible imminent hostilities. 20 lb. spool—\$11.95. Smaller quantities per lb.—75c.

1000 CYCLE AUDIO FILTERS

Navy PD52010-1 low pass audio filters as mentioned in the "Peaked Audio" article in June CQ, and designated by the above number, are the exact electrical and physical equivalent of commercial audio filter units selling for \$35.00 wholesale. They are infinitely better than the surplus "Radio Range Filters" being sold for reducing QRM, and at 2 KC off resonance for example, a 2 section filter using PD52010-1 is capable of twice the selectivity available thru the use of the Q5-er (the BC453 section of the 274N which has provided the amateur's previous highest standard of interference elimination). EXTRA SPECIAL—NAVY PD52010-1 with diagram...\$5.00

RADIO SET SCOOP. Product of a famous aircraft radio manufacturer who has abandoned the manufacture of table model radios because of the flood of government orders. All in 5 ply genuine mahogany cabinets, both regular and bleached. 6-tube models have tone control, Original list price given first—then your cost. Sensational discounts.

- Model 565, Mah. or blonde, \$34.95-\$16.97
- Model 6618, Mah. or blonde, \$44.95-\$20.97
- Model 663, Mah. or blonde, \$46.95-\$21.97

BUFFALO RADIO SUPPLY, 219-221 Genesee St., Dept. RC-10 BUFFALO 3, N. Y.

AMPERITE

Studio Microphones
at P.A. Prices

Ideal for BROADCASTING

- RECORDING
- PUBLIC ADDRESS

"The ultimate in microphone quality," says Evan Rushing, sound engineer of the Hotel New Yorker.

- Shout right into the new Amperite Microphone—or stand 2 feet away—reproduction is always perfect.
- The only type microphone that is not affected by any climatic conditions.
- Guaranteed to withstand more "knocking around" than any other type mike.

Special Offer: Write for Special Introductory Offer, and 4-page illustrated folder.



Models
RBLG—200 ohms
RBHG—Hi-imp.
List \$42.00



"Kontak" Mikes
Model SKH, list \$12.00
Model KKH, list \$18.00

AMPERITE Company Inc.

561 BROADWAY · NEW YORK 12, N. Y.

In Canada: Atlas Radio Corp., Ltd., 560 King St. W., Toronto

BREngle SHIFTS FIRMS
Ralph T. Brengle, president of the National Association of Relay Manufacturers, has recently announced that, effective July 1, 1948, he will devote his full time to Potter & Brumfield, Chicago, manufacturer of industrial relays.



Mr. Brengle is a substantial stockholder and officer of Potter & Brumfield, and for several years has handled their national sales and advertising. He has discontinued his operations as Ralph T. Brengle Sales Co., manufacturers representative, and has turned this phase of his business over to the newly formed Lund-Hansen Co., who will continue to represent Potter & Brumfield and other lines formerly handled by Mr. Brengle in the Chicago area.

GUSTAFSON GETS MEDAL

G. E. Gustafson, Zenith Radio Corporation's vice-president in charge of engineering, recently received the President's Medal of Merit for his contribution to victory in World War II. The medal was presented at a luncheon sponsored by the Chicago Association of Commerce and Industry. The Medal of Merit is the highest award given civilians by the President of the United States. It was presented to Gustafson for his war work as chief of Zenith's engineering research, which helped make possible that company's successful production of war material, including the V-T fuse.



R. W. METZNER DIES

General Electric Company has announced the death of Russell W. Metzner, sales manager of the replacement tube division. Mr. Metzner, known throughout the country as a top sales executive in the radio receiving tube field, died July 20 after a brief illness. Up to 1945, he was connected with Ken-Rad Tube & Lamp Corporation of Owensboro, Ky., and in that year he became associated with General Electric.

TURNER'S NEW CHIEF ENGINEER

Mr. Ronald P. Evans, Turner Company president, announced last month that Mr. Paul Thompson has been named chief electronic engineer of the Turner Company, Cedar Rapids, Iowa. Mr. Thompson, a graduate of the University of Minnesota with a degree in electrical engineering, comes to Turner with a wide range of experience in electro-acoustic engineering. As head of the Turner engineering staff, his attention will be devoted mainly to research and product development of microphones and electronic equipment.

AMPLIFIER AND KEYS

TG-10 AUTOMATIC KEYS—Amplifier 25 Watt. This well designed keyer can be used for radio classes. Photo cell is actuated by ink tape recording; can be converted easily to a 25 Watt amplifier. 110 Volt 60 cycle operation. Comes with two 6L6's, two 6SJ7's, two 6N7's, and one 5U4G output trans., 4, 8, and 15 ohm. Tape motor can be used as phono motor. Used (Tested) \$19.95



INTERPHONE AMPLIFIER BC-347

Army Aircraft Type: Uses 6F8 Tube. Contains two (2) Midget High Fidelity UTC speaker transformers (7/8" x 1 1/8"). Input 200 ohm to single or push-pull Grid; Output 200 ohm from single or push-pull plate; plus resistors, cond., etc. Completely enclosed. With Schematic. Size: 2 1/2" x 4" x 6". Less Tube—Price—79c

each—NEW Or: Three (3) for \$2.00

0-500 MICROAMMETER

0-15 and 0-600 D.C. Volt Scale with Multipliers. Price—NEW \$2.95

BC-223 TRANSMITTER TUNING UNITS

TU-17 Frequency 2000 KC to 3000 KC
TU-18 Frequency 3000 KC to 4500 KC
TU-25 Frequency 3700 KC to 5250 KC
Price—NEW \$4.50

B 19 MARK II TRANSMITTING & RECEIVING SETS

15 Tube SET, complete with all spare parts, ready to operate. Frequency 2 to 8 Mc. 235 Mc and two tube amplifier. Price—NEW \$59.50

U.H.F. COAXIAL CABLE—125 ohm, flexible Poly-styrene, beaded, cotton covered. Amp. 70-30. Prices: 50 Ft. roll \$1.25 Two 50 Ft. rolls for \$2.00

ADDRESS DEPT. RC Prices F.O.B., Lima, Ohio 25% DEPOSIT On C.O.D. Orders

SELSYN TRANSMITTER AND INDICATOR



Ideal as Radio Beam position Indicator, for Ham, Television, or Commercial use. Complete with 1-82 five inch indicator, Autocyan Trans. 12 Volt 60 cycle transformer, and wiring instructions. Price: NEW \$7.95

ANTENNA MAST MOUNT

Multiple Mast Mount—Can be mounted on chimneys, on gable, slanted, or flat roofs or on sides or corners of brick or frame walls. Ideal for holding all popular types of antenna in sizes up to 1 1/2" diameter. Made of aluminum, with steel hardware, plated. Complete \$6.95 with banding for chimney mounting. (NEW) Complete—less banding. (NEW) \$4.95

MG-149 F INVERTER

Used to operate Radio Compasses. Input 24 Volt DC; Output 26 Volts 400 cycle 250 VA or 115 Volt 400 VA 400 cycle. Used—Reconditioned and Tested \$9.95

DYNAMOTORS

MOBILE USE—9 Volt input; Output 405 Volts 95 MA. Also will operate from 6 Volt input; Output 280 Volts 95 MA. Size: 3" x 7" DM 635X \$3.95



BATTERY BALANCING SWITCH AND METER

Weston Meter 2" with 0-15 DC Volt Scale. Heavy Duty D.P.D.T. 20 amp. switch, Indicator Light, and S.P.S.T. Switch housed in metal box 3" x 1 1/2" x 6". Used for balancing load on batteries and reading voltage under load. Price: NEW \$2.95

FAIR RADIO SALES

132 SOUTH MAIN ST. LIMA, OHIO

Binaural Amplifier

By EDWIN BOHR

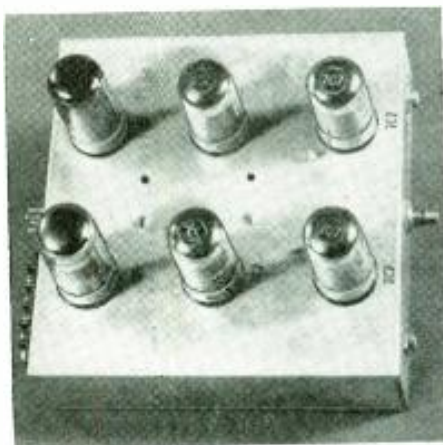

This amplifier has two identical channels.

MOST of the sound we hear does not come from the source of the sound straight to our ears. In an ordinary living room over 90% of the sound bounces several times from the walls, floor, ceiling, and furniture before we hear it!

Because we are used to this echoing it sounds natural to us. Unless it is very bad, as it might be in a large marble-walled chamber (a railroad station for instance), we can still tell from which direction a sound is coming. Our two ears are spaced several inches apart. We unconsciously calculate the intensity of the sound coming to each ear from the various directions and, because we are used to the echoes, our brain is able to focus attention on the sound we want to hear. The process is very much like that which surveyors call triangulation.

In Fig. 1, a top view of a pair of ears and a sound source, the path from the source to the right ear is shorter than that from the source to the other ear. The intensity of sound in the right ear, therefore, will be slightly greater. Depending on the difference of levels in the ears, we subconsciously plot the position of the source.

When there is some echo, the echoed sounds reach our ears with varying intensities. None of the echoes (in an average room) is as loud as the direct sound even though all the echoes added together may be much louder. The original triangulation still takes place, and the echo only gives naturalness to the sound, because we are used to it.

The ordinary electronic audio system has only one "ear," the microphone. The single microphone picks up sounds from all directions within its range with near-

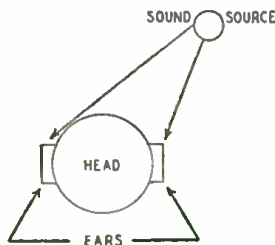
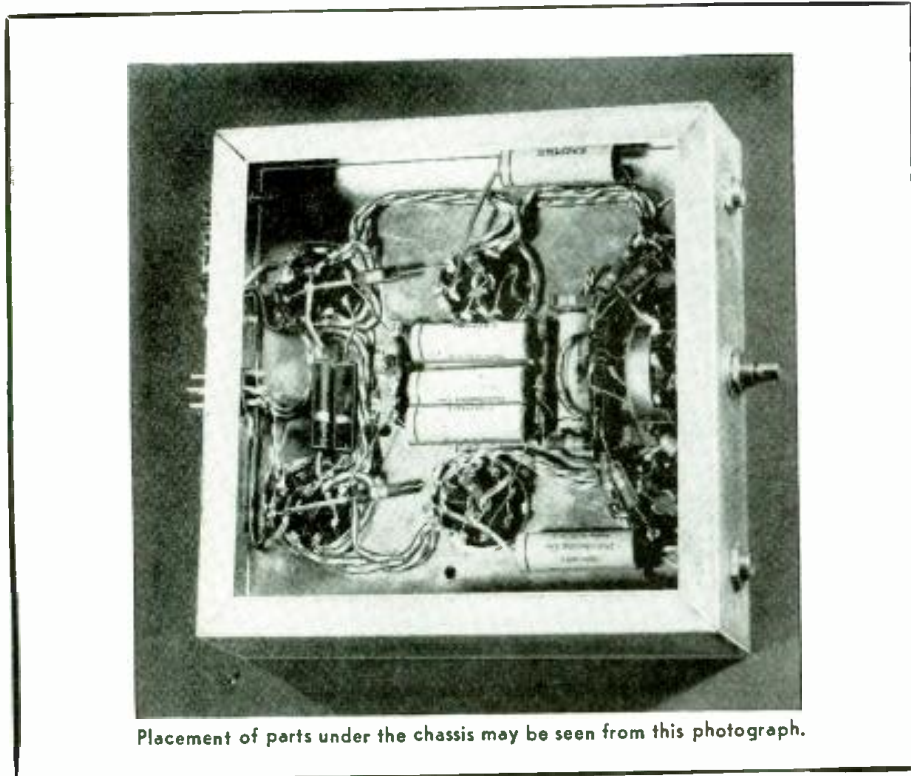

Fig. 1—How we know the direction of sounds.

ly equal efficiency. Even though the direct path from sound source to microphone may give louder amplifier out-



Placement of parts under the chassis may be seen from this photograph.

It's Mutual Help!

Give Us Your Order and We'll Give Low Prices on Your Radio and Electronic Requirements!

Here are Only a Few Specials!

Our 3-Item Special!

- 1—Standard-Phono Motor—9" Turntable
 - 2—Crystal-Pickup—incl. HDWE.
 - 3—Covered record Player Base—13x8/4x 3 1/2 with cut-out for Motor
- SPECIAL, ALL 3 for \$ 4.50
In Lots of 10 42.50

Over 100 Assorted Resistors	1-15
1/4 to 2 Watts	25.00
In Lots of 25	
50L6 Output Transformers, ea.	.32
In Lots of 25	7.50
12SR7 Sealed Carton Tubes	.30
100 or More	27.00
470 ohm-10W. Resistors	.07
40 ohm-10W. Resistor, Lots of 100	5.00
8 Ft. GE Approved Rubber Line Cord, each	.15
Lots of 100	12.00

All Merchandise Guaranteed
New and Standard Brands
Refund in 10 Days if Returned Prepaid
Send 20% Deposit With Order
Balance C.O.D. Merchandise F.D.B. N.Y.C.

WOrth 4-1368

ALMO ELECTRONICS INC.

135 Liberty St. New York 6, N. Y.
OUR ONLY BRANCH

Make Your Own

RECORDS

with RISCO 3-way Home Recorder

"Snapshots in Sound"

Over 10 minutes recording on a 10" record at dual speed—4 1/2 min. at single speed.

- High fidelity record player
- Uses professional recorder
- An auxiliary P.A. amplifier



Ready to operate with 6" spk, crystal mike. Ideal for music lessons, parties, your child's cute sayings—Speeches. Churches. **\$49.50**

Attractive Portable Case \$5 EXTRA FOR SEND FOR COMPLETE DETAILS DUAL SPEED

Make your own Record Library! Copy your friends records and Save Money

RECORDISC	RECORDING	BLANKS	We Sell Retail
Base	6 1/2 in.	8 in. 10 in.	Steel Stylus Cutting Needle, 3 for 79c. Tungsten tip p.c.d. 5,000 Playback Needle. \$1.00
Bond	9c	15c 21c	
Aluminum	18c	24c 36c	

25% on CDD orders—ORDER FROM THIS AD

RISCO ELECTRONICS

WHOLESALE DISTRIBUTORS
25 West Broadway, N. Y. 7, N. Y.

GREYLOCK

A Dependable Name in
RADIO TUBES

GT, Glass, and Miniature Types.
All Tubes Individually Boxed.
12SA7, 12SK7, 12SQ7, 50L6, 12AT6, 12BA6, 12BE6, 35W4, 50B5, 1R5, 1S5, 1T6, 35A, 3QA, 6AK5, 6AC5, 6AQ5, 6BE6, 6BA6, 6AU6, 6BJ6, 6X4, 11723, 32L7, 70L7, 117L7, each 59c
All Tubes carry RMA 90-Day Guarantee

PM SPEAKERS

4" Ainico No. 5 each \$1.19
5" Ainico No. 5 each 1.29

TERMS: Net CDD. No order accepted for less than \$5.00
WRITE FOR BARGAIN CATALOG C-10

GREYLOCK ELECTRONIC SUPPLY CO.
30 Church Street New York 7, N. Y.

NOW! BUILD 15 RADIOS \$14⁷⁵

COMPLETE KIT ONLY...



ABSOLUTELY NO KNOWLEDGE OF RADIO NECESSARY
YOU NEED NO ADDITIONAL PARTS!

THE PROGRESSIVE RADIO KIT is the ONLY COMPLETE KIT

Operates on 110-120 volts AC/DC. Contains everything you need. Instruction Book, Metal Chassis, Tubes, Condensers, Resistors, and all other necessary radio parts. The 36-page Instruction Book written by expert radio instructors and engineers teaches you to build radios in a professional manner. The first circuit built is a simple one-tube detector receiver. Each succeeding circuit incorporates new arrangements of detectors, RF and AF amplifiers. This kit is excellent for learning the principles of receiver, transmitter and amplifier design. It is used in many radio schools and colleges. All of the commonly-used detectors are used, including diode, grid leak, plate and infinite-impedance. The transmitters are designed with Hartley and Armstrong oscillators, using screen-grid and control-grid modulation. Both vacuum tube and selenium rectification

are employed in these circuits. The circuits are designed to provide excellent performance. Altogether, fifteen circuits are constructed, including 11 receivers, 1 audio amplifier, and 3 transmitters. The sets start with simple circuits of 1 tube plus rectifier, gradually grow more complex, and finish with several examples of radio sets using three tubes plus rectifier.

PROGRESSIVE RADIO KIT . . . ONLY \$14.75
SPECIAL FREE OFFER

Electrical and Radio Tester sent absolutely FREE with each Progressive Radio Kit. PLUS FREE membership in Progressive Radio Club. Entitles you to free expert advice and consultation service with licensed radio technician. Write for further information or ORDER your KIT NOW!

WE PAY POSTAGE ON PREPAID ORDERS

C.O.D. ORDERS SHIPPED COLLECT

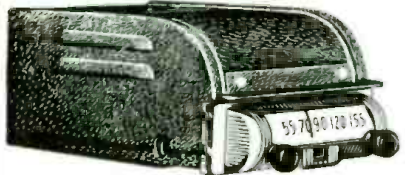

RECHARGE your AUTO BATTERY with the NEW AUTO RADIO

WITH BUILT-IN BATTERY CHARGER
 PAT. PENDING ALSO BUILT-IN POWERIZER FOR ELECTRIC SHAVER
SENSATIONAL FEATURES

- Powerful 6-Tube radio • 3 Gang Condenser • Extra R.F. Stage (for increased Sensitivity) • Large P.M. Speaker • Single Compact Unit • Easily Installed • Charges Through Radio • Simply Plug Radio Cord into 117 v.A.C. electric Outlet • Makes Winter Starting Sure • For Electric Shaver • Just Plug Shaver Into Radio Extension Cord.

ONLY **\$34⁹⁷** LIST PRICE **\$49.95**

Automatic AUTO RADIO

Tops in car radios, now at a new low price! Six-tube superheterodyne, with steady, full-toned reception. Mounting brackets included for easy installation in your car. Don't miss this big bargain!

- Six Tube Superheterodyne • Three Gang Condenser • Powerful Long Distance Reception • Fits All Cars, Only **\$27.97**
- Easy Installation • Mounting Brackets Included. LIST PRICE \$39.95

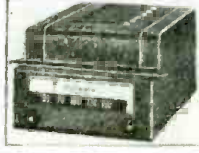

TOM THUMB BIKE PORTABLE RADIO

- TELESCOPIC ANTENNA • POWERFUL RECEPTION
- EASY MOUNTING • BEAUTIFULLY FINISHED METAL CASE

Can be mounted on bicycle or carried as a personal portable radio. Supplied complete with all bicycle mounting hardware and telescopic antenna. Simple mounting—quickly detachable. Whip antenna, slide rule dial, vernier tuning, full size alnico 25 speaker—operates on inexpensive flashlight cells and standard 67½ volt "B" battery. Attached handle for ease in carrying as a regular portable. Light weight case, beautifully hammer-tone finished. Mounting bracket features anti-theft locking device. Size 7¼ x 4¼ x 3½, Weight 3 lbs. 3 oz.



ONLY **\$17.47** LIST PRICE \$24.95

ATTENTION RADIOMEN!! Send for Your FREE DEALERS catalog and Price List Today!

- RADIO KITS • AMPLIFIER KITS • FM COIL & CONDENSER KITS • RESISTOR KITS
- CONDENSER KITS • RADIO TOOL KITS • FM-AM CHASSIS • SPEAKERS • RADIO PARTS • PORTABLE RADIOS • CAMERA-RADIOS • TUBES • AUTO RADIOS • HOME RADIOS • TELEVISION SETS • TELEVISION CABINETS • TEST EQUIPMENT • FM TUNERS

PROGRESSIVE ELECTRONICS CO.

DEPT. RC-18 497 UNION AVE. BROOKLYN 11, N. Y.

speaker is still not natural because it has been picked up and comes out from only one point (the speaker), even though the source may be a large symphony orchestra spread over a wide stage.

It is possible to make a sound system which is actually *binaural*. That is, it gives the same effect as hearing with both ears. It does this by using two microphones, placed approximately the same distance apart as a person's ears (Fig. 2). Each microphone feeds a separate amplifier and the output of each amplifier is fed to a single earphone. When one of these earphones is worn against each of the listener's ears, the sound he hears is truly binaural because each ear is effectively placed just where the corresponding microphone is located.

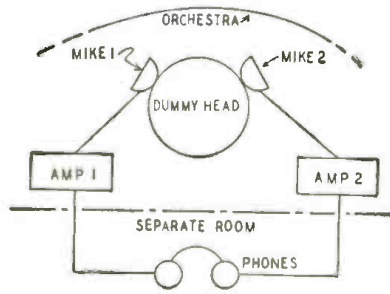

Fig. 2—Binaural sound and audio equipment.

A number of interesting effects ought to result. Wearing the headphones and unable to see the room in which the microphones are placed, the listener ought to be able to tell whether voices and music come from the left or the right. If a person walks across the room, speaking all the time, the headphone-wearer ought to be able to "follow" the speaker in his path from one side of the room to the other.

We decided to find out how well this theory reduces to practice.

Fig. 3 shows the amplifier used. Actually there are two completely separate amplifiers here, both built on the same chassis. Each has its own input and output. However, the gain controls are ganged so that the gain of both amplifiers will always be very nearly the same. Ganged 1-megohm potentiometers should not be hard to find as they are stock items. They do not have to be used, though, since ordinary single controls will give the same results if they are provided with dial scales so that they can be set to the same points by hand.

put, the echoes become very annoying because the single ear cannot perform the triangulation necessary to focus its attention on a particular spot. As a result, echoes, air noises, clocks ticking, footsteps, and all sorts of noises become very obtrusive in the loudspeaker. They may even drown out the desired sound or make it unintelligible. They sound unnatural at the very least. The effect can be simulated in a noisy location by stopping up one ear and noting the apparent increase in background noise and the difficulty of understanding speech from any distance.

To overcome this, broadcast and recording studios are acoustically treated to deaden a large part of the echo. Sound-absorbent material is placed on the walls and ceiling, and echo is re-

duced enough to kill interfering noises. But the sound coming from the loud-

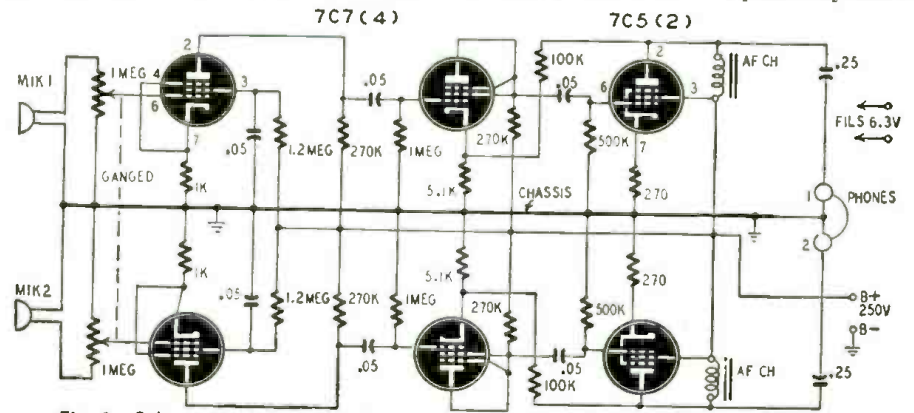

Fig. 3—Schematic of amplifier. Any two amplifiers may be used if they are identical.

No construction details are given, as any *exactly similar* pair of amplifiers may be used.

The two microphones should be identical. Use the same length of cable for both to reduce output and high-frequency response by the same amounts (if at all). The higher the fidelity of the whole system the better, but both channels must be the same in every detail.

The power supply was built on a separate chassis to minimize inductive hum pickup. Almost any audio chokes can be used. Do not put loudspeakers on the amplifier outputs, as the binaural effect is best with headphones.

The two microphones were placed in a room about 15 x 20 feet. They were spaced about 8 inches apart. The listener wearing the headphones was in a separate room. In the room with the microphone two people were holding a conversation and a radio was playing softly.

First, just one microphone was connected. As expected, the sound seemed to come from a deserted armory, the usual effect with single-channel systems when the sound source is 'way off mike. The conversation was hard to understand, and the rustles of cloth and the hiss of air movement were very obtrusive.

Now we connected both microphones. Immediately the background noise seemed to lessen. The voices could be understood clearly. We could sense that the voices came from one direction and the music from a different point.

The phones used were magnetics and we thought higher-fidelity phones might improve results. So we connected in a pair of crystal units. The results were very much improved. The higher-frequency sounds, whose reflection as echoes are much more efficient, were heard and more realism and sense of direction were felt. The sound was natural in a different sort of way from the usual "high-fidelity" reproduction. There was a sense of "presence," as if the listener were actually in the same room as the sound. This is impossible with single-channel systems because the directional distribution of the sound cannot be transmitted.

It is very possible that binaural transmission will be introduced to the public before very long. Experiments have been carried out in England with two microphones, two transmitters, and two receivers. In the United States experiments of the McClatchy Broadcasting Company have definitely shown that audiences prefer double-channel reproduction.

In June of this year, Marvin Camras of the Armour Research Foundation demonstrated binaural reproduction before the New York Section of the IRE. He used a specially built dual-channel magnetic recorder which carries two separate sound tracks at the same time. The output of each one is fed into a separate loudspeaker, and the two speakers are located at a distance from each other.

FULL 13 CHANNEL TV-FM COVERAGE!

It's Here...
**NEW JFD
Super-Beam HI-LO
Duo-Orienting Array**

FEATURES!

- ✓ JFD All-Angle Steel Mounting Bracket for erection of masts anywhere.
- ✓ Corrosion-proof 7 1/2' mast.
- ✓ Frequency Range 44-216 mc. and -- 4.2 DB gain.
- ✓ Minimized ghost effects.
- ✓ U-Bolt Clamp securely attaches array to mast, provides unlimited spacing of bays and allows them to be oriented independently.
- ✓ Unbreakable polystyrene Rotolock insulator insures high frequency insulation.
- ✓ Lightning-fast assembly time -- no hardware bag.

Folded Dipole with Reflector
No. TA115

RECOMMENDED

For use with Hallicrafter, Philco, RCA, Stromberg-Carlson, Emerson, Admiral, Crosley, Dumont, DeWald, Motorola, Teletone, Fada, Garod and other television sets.

Write for the New JFD 16-page Super-Beam Catalog, No. 7810S.



MANUFACTURING CO. Inc.

4112 Ft. Hamilton Pkwy.

Brooklyn 19, N. Y.

AUXILIARY SPEAKER

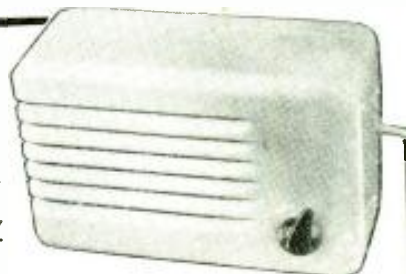

Control distribution of sound with supplementary speakers connected to radio, TV receiver, phonograph or P-A amplifier.

Ideal for homes, bars, grills, hospitals, fairs, etc., for more and better sound where you want it.

- ★ Fully enclosed unbreakable cast-aluminum case.
- ★ Built-in volume control. • Best 4" P.M. speaker.
- ★ Simple to install—directions with each shipment.
- ★ As many as 8 speakers have been connected to standard radio or TV receiver without alterations.
- ★ In 7 beautiful glossy colors—Ivory, Red, Mahogany, Light Blue, Nile Green, Gray and White. Unless otherwise specified, speakers will be shipped in Ivory.

Size: 5" x 7" x 3" deep.
Open back, \$5.75. Closed back, \$6.95.
Fully guaranteed. Money refunded if not fully satisfied.

Also available in vertical waterproof model for outdoor theatre use, with L-pad volume control and waterproof speaker. Full details on request.

TARRYTOWN METALCRAFT CORP., 84 Chestnut St., Tarrytown, N.Y.

HOW TO GET THE MOST from only BASIC TEST EQUIPMENT

Servicing by Signal Substitution
The Simple, Modern, Dynamic Speed approach to receiver alignment and adjustment problems, FM-AM-TV.

- Nothing complex to learn
- No extra equipment to purchase
- Universal — non-obsolete
- Employs only Basic Test Equipment



S-S tells HOW — in simple, direct language.

New 9th edition now off the press. 100 pages of valuable information.

Available from all leading radio parts and equipment distributors or directly from factory at only 40c per copy.

PRECISION APPARATUS COMPANY, Inc. • 92-27 Horace Harding Blvd., Elmhurst 4, N. Y.

New practical ELECTRICAL guide



For easier, better work, and more profits on down-to-earth electrical jobs—new handbook gives hundreds of useful facts, data, and methods, in handy form, at low price of only

\$2.50

Just Out!

ELECTRICIANS' POCKET COMPANION

By Benjamin Goldberg

Formerly Electrical Inspector, New York City

375 pages 4½ x 7, hundreds of illustrations, charts, diagrams, and tables

Here, at your fingertips is a comprehensive selection of the important facts, figures and data the electrician needs to know about modern electrical work. The Electricians' Pocket Companion answers your questions, gives needed information based on the National Electrical Code and Underwriters' requirements; supplies diagrams; tells what to do. It covers the entire range of subjects from meters, meters and transformers to lighting, wiring, and literally hundreds of others. In addition it contains a clear explanation of electrical fundamentals and mathematics. The author is a practical electrician of broad experience and has made a good choice of the most helpful practical material—and the price is much less than that of other handbooks. While smaller and more convenient, The Electricians' Pocket Companion presents all tables, diagrams, etc., in large, easily read size. Four different indexes give quick access to any fact need in your work.

SAVE TIME - WORK MORE EFFICIENTLY

With helpful data, diagrams and tabulations on subjects like these:

Electrical Fundamentals
Meanings of Terms Commonly Used in Electrical Work
Electricians' Tools
Methods of Work
Electric Meters
Transformer Connection Schemes
Electric Motors
Typical Control Schemes for AC Starters
Lighting and Signal Circuits
Insulation Resistance Testing
Electrical Equipment Troubles
Illumination Values
Residence Wiring Systems
Electrical Symbols and Abbreviations
Electrical Formulas and Their Applications
Electrical Code Tables, Diagrams and Examples
Standards for Electrical Materials, Equipment and Installations
Domestic Heating System Controls
Safety Cautions and Emergency First Aid . . . and many more

HOW TO REPAIR ELECTRIC MOTORS

Also published by Murray Hill Rosenberg's ELECTRIC MOTOR REPAIR fully and plainly covers repair and rewinding of all kinds of motors, also motor controls, 560 pages, 600 illustrations, \$5.00. Try it 10 days at our risk.

TEN DAYS' TRIAL

Dept. RC-108, Murray Hill Books, Inc.,
232 Madison Ave., New York 16, N. Y.

Send the books checked below for 10 days' examination on approval. In 10 days, I will pay for books plus a few cents postage, or return them postpaid. (Postage paid on cash orders; same return privilege. Books sent on approval in U. S. only.)

ELECTRICIANS' POCKET COMPANION, \$2.50
 ELECTRIC MOTOR REPAIR, \$5. (5.50 outside U.S.A.)

Name

Address

City, Zone, State

Occupation

European Report

By Major Ralph W. Hallows

RADIO-ELECTRONICS LONDON CORRESPONDENT



THE British gramophone or radiogramophone (radiogram, for short), called in America the phonograph or radio-phonograph, is a considerably more important provider of home entertainment in Britain than in the United States. The main reason, I fancy, is that our folk have a much smaller choice of radio programs. Even if you live in or near London and have a reasonably good radio receiver, your available programs during the daytime, when continental stations on the 500-1500-ke waveband don't usually provide worthwhile reception, are not generally more than three. The BBC offers two, called the Home Program and the Light Program, and you may be able to pull in Luxembourg. It's only natural that this selection can't please everyone; but if you have a radiogram—forgive me, a radio-phonograph—and a good selection of records, there's no need to shed any tears over that problem, unhappy as it may be.

The phonograph pickup

Naturally we pay a lot of attention to pickups. The chief aims of inventors are to reduce needle scratch to a minimum and to obtain the maximum frequency response. The two are hardly compatible, since the better the upper a.f. response of the pickup, the more is surface noise brought out. Still, several recent tests before audiences with trained musical ears seem to show that reproduction with plenty of top and a good deal of needle scratch is far more acceptable than that with not very much of either.

A novel ribbon pickup was demonstrated by its inventor, J. H. Brierley, to an important London musical society last month. The construction is shown in Fig. 1. The ribbon is a U-shaped piece of foil lying parallel to the plane of the lines of force of the magnetic field. The bridge piece, of light plastic material, is cemented to the foil

and carries a stylus of tungsten carbide. A non-flaking carbide—many times harder than sapphire—is used. As the moving parts have less than one twentieth the weight of an ordinary needle, record wear is very light. This pickup has an excellent response from about 30 to 15,000 cycles a second. The musical quality is certainly there—but so, alas, is the surface noise!

Phonograph and broadcasting

So much use is made of recordings for broadcasting and so important have the phonograph and other instruments become for this purpose, that the BBC has for some time now had one of the country's leading research and development departments in the recording field, headed by M. J. L. Pulling. The standard maintained is a high one: at all frequencies between 50 and 8,000 cycles the relative levels at the output of a reproducing chain must be within plus or minus 2 db of those at the input of the recording chain; noise of all kinds introduced by both chains must be at least 55 db below peak signal level.

Many ingenious improvements have been made. The discs normally used are of 17¼-inch diameter and run at either 78 or 33 1/3 r.p.m. It is not always realized that the track speed of the record sets the upper limit of the a.f.'s that can be reproduced. With a disc revolving at a constant rate, track speed decreases as the cutter moves inward. In fact, if a reproducer were designed to give a de-

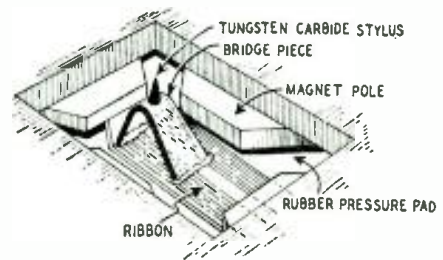

Fig. 1—Details of new Brierley ribbon pickup. sired response near the start of the grooves, the upper a.f. limit halfway to the center would be a whole octave lower.

There are several ways out of this difficulty. One is to use only a small band near the outside edge of a large disc for recording. The drawback here is that even large-diameter records made in this way have only 2 to 3 minutes playing time for the best results.

Another is known as automatic radius compensation. A frequency discriminator network with several variable elements is used. As the recording head travels over the disc a progressive variation takes place, giving more and more pre-emphasis to the upper frequencies

TUBES! NATIONALLY ADVERTISED BRANDS TUBES!

RCA — Kenrad — Sylvania — Tung-Sol — National Union — Raytheon — Philco — Hytron
All new tubes, 100% guaranteed. Individually boxed.

SPECIAL PURPOSE RADIO TUBES

Cathode Ray	Special Purpose
3API ... \$2.95	10Y ... \$.95
3BP1 ... 2.95	3B22 ... 3.95
5CP7 ... 3.95	C6J ... 3.95
5FP7 ... 3.95	4B24 ... 3.95
7BP7 ... 3.95	531 ... 9.95
9LP7 ... 4.95	717A ... 1.95
12GP7 ... 8.95	86485
	725A ... 11.95
	730A ... 5.95
	215A ... 1.95

SPEAKERS

4" PM Speaker.....	\$1.25
5" PM Speaker.....	1.25
6" PM Speaker.....	1.98

SPECIAL! VOLUME CONTROL 99C

1/2 meg with switch... 3 for
TERMS: 25% with Order—
Balance C.O.D.—F.O.B. Chicago
Prices Subject to Change
Without Notice

TYPE	PRICE	TYPE	PRICE	TYPE	PRICE	TYPE	PRICE	TYPE	PRICE	TYPE	PRICE
O1A	\$.05	3Q5GT	\$.80	6N5	\$.80	6U6GT	\$.65	7C6	\$.65	32L7GT	\$1.15
OZ4	.80	3S4	.65	6N7	.80	4U7G	.54	7C7	.65	33	.96
IA3P	.65	3R4GY	1.15	6P5GT	.65	3V6GT	.65	7E6	.65	34	.96
IA5GT	1.15	5U4G	1.45	6P7G	1.15	3V7G	.65	7E7	.80	35A5	.65
IA6	.96	5V4G	.80	6Q7	.65	5W7G	.80	7F7	.80	35L6GT	.54
IA7GT	.65	5W4GT	.65	6R7G	.54	3X5GT	.45	7G7	.96	35W4	.45
IB4P	1.15	5X4G	.54	6S7G	.96	8Y6G	.80	7H7	.80	35Y4	.65
IB5	.96	5Y3GT	.40	6S8GT	.80	6Y7G	.80	7J7	.96	35Z5GT	.45
IC5	.65	5Y4G	.45	6SA7GT	.54	6Z5	1.15	7L7	.80	36	.80
IC7G	.96	5Z3	.54	6SC7	.65	6Z7G	1.15	7N7	.80	37	.54
ID5G	1.15	6A3	.96	6SD7GT	.65	7A4	.65	7O7	.65	38	.65
ID7G	.96	6A4 LA	.96	6SF5	.54	7A5	.65	7V7	.96	39	.80
ID8G	1.15	6A5G	1.15	6SF7	.65	7A6	.65	7W7	.96	40	.80
IE5GP	1.15	6A6	.80	6SG7	.65	7A7	.65	7X7	.96	41	.80
IE7G	1.15	6A7	.65	6SH7GT	.65	7A8	.65	7Y7	.96	42	.54
IF4G	.80	6AB7	.96	6SK7GT	.54	7B4	.65	7Z4	.65	43	.54
IF6G	1.15	6AC7	.96	6SK7GT	.80	7B5	.65	12A	.45	45	.54
IF7	1.15	6AD6	.80	6SN7GT	.80	7B6	.65	12A5	1.15	45Z3	.54
IG4G	.65	6AE5GT	.65	6SQ7GT	.54	7B8	.65	12A6	.96	45Z5GT	.54
IG5G	.80	6AF5G	.96	6SR7	.54	7C4	.65	12A7	.80	46	.80
IG6G	.80	6AG5	.96	6S7G/6G5	.65	7C5	.65	12A8	.65	50	1.15
IH4GT	.65	6AG7	.96					12B6	.65	50A5	.80
IH6G	.96	6AK5	.80					12C8	.96	50B5	.65
IJ6G	.96	6AL5	.65					12F5GT	.54	50L6GT	.80
IL4	.65	6AT6	.54					12H6	.54	50X6GT	.80
ILA4	.96	6B4G	.96					12HG7	.45	53	.80
ILB4	.96	6B8	.96					12K8	.80	56	.54
ILC5	.96	6C4	.54					12SA7GT	.65	57	.65
ILD5	.96	6C5	.54					12SC7	.65	58	.65
ILH4	.96	6C6	.65					12SF5	.54	70L7GT	1.15
ILN5	.96	6C8G	.96					12SF7	.65	71A	.65
IN5GT	.65	6D5	.65					12SG7	.65	75	.80
IN6G	.65	6E5	.54					12SH7	.65	76	.54
IQ5GT	.96	6F5GT	.54					12S17GT	.65	77	.54
IR4	.96	6F6	.65					12SK7GT	.54	78	.54
IR5	.65	6F6GT	.54					12SL7GT	.80	79	.80
IS4	.80	6F7	.96					12SN7GT	.80	80	.45
IS5	.65	6F8G	.96					12SQ7GT	.54	81	1.15
IT4	.65	6G6G	.80					12SR7	.65	82	.80
IT5GT	.80	6H5GT	.54					12T3	.80	83V	.96
IW	.65	6J5GT	.50					14A7	.80	84/6G4	.54
2A3	.96	6J5G	.50					14N7	.96	85	.65
2A4G	1.15	6J6	.96					14O7	.65	89	.65
2A5	.65	6J7GT	.65					14R7	.80	117L7GT	1.15
2A6	.80	6J8G	.96					25L6GT	.54	117M7GT	1.15
2B7	.80	6K6GT	.54					25Z5	.54	117P7GT	1.15
2X2/879	1.15	6K7	.50					25Z6GT	.54	117Z3	.65
3A4	.65	6K8	.80					26	.65	117Z6GT	.80
3B7/1291	.96	6L5G	.80					26A7	1.15	VR90	.80
3D6/1299	.96	6L6GA	.96					27	.45	VR105	.80
3Q4	.65	6L7G	.80					30	.65	VR150	.80
								31	.80	9001	.80
								32	.96	FM-1000	1.15



ELECTRIC PORTABLE PHONOGRAPH

Leatherette Covered. 2 Watt Amplifier. Plays 12 inch records with cover closed. 5 Inch Alnico 5 Speaker. Rim drive constant speed. Self starting motor. High fidelity pickup. Size 17"x13"x7 1/2".
List Price \$29.95.
NET PRICE \$15.95
LOTS OF THREE \$14.95

FRANKLIN-ELLIS CO. 1313 West Randolph Street
Dept. RC-10 Chicago 7, Illinois

as it approaches the center of the disc. Another method is now under development which would seem to give the perfect answer—if only it could be produced in troublefree form at reasonable cost. What is wanted is a means of rotating flat disc records at constant track speed instead of at constant angular velocity. Several methods have been suggested; but all so far have been too complicated or too expensive. One way out of that difficulty would be to use cylindrical records of the original Edison type. The trouble is that they are too fragile and need too much storage space.

"Second-hand" recordings
All disc recorders and reproducers used by the BBC consist of dual units. When a long program is being recorded the turntables of both units revolve, though as a rule only one disc is being cut. Monitoring is perfect, for following just behind the recording head is a reproducing head which can be brought into action by a pushbutton switch. It is also possible by using another switch to make the reproducing head on recorder No. 1 feed the cutter on recorder No. 2. And, having made what we may call a second-hand record on recorder No. 2, a most interesting experiment can be made.

The original piece comes to an end. Put a new disc on recorder No. 1 and record on this the second-hand record

from No. 2, making a third-hand recording. You can continue the process as long as you like. Some while ago I was given a very interesting demonstration of what happens if you do. You have to listen pretty hard to notice much difference between first-hand and third-

hand recordings. There is a perceptible difference at fifth-hand and by about eighth-hand the record becomes unacceptable. This is good proof that the system is effective, for any distortion or frequency discrimination introduced by
(Continued on following page)



Fig. 2—With this device the operator can "tap in" or find any desired point on a recording.

IF . . .

there is something in this issue that you would like to own or see demonstrated . . .

WRITE

to: The West Coast Headquarters for SOUND EQUIPMENT or . . .

VISIT

our Sound Demonstration Rooms.

KIERULFF & COMPANY

820-30 W. Olympic Blvd.
Los Angeles 15, Calif.
Richmond 70271

STEADY PROFITS



Your Own Business with

CORADIO

The Coin Operated Radio. Place these specially built radios that play 1 or 2 hours for 25c in the thousands of available hotel rooms, tourist courts, etc. They yield immediate profits and steady income. Install Coradio, the finest made. Limited capital required. Send for further information. Write today.

CORADIO Coin Operated Radio

Dept. B.

212 Broadway, Phone: BEekman 3-0038-9
NEW YORK 7, N. Y.

PEN-OSCIL-LITE

Extremely convenient test oscillator for all radio servicing: alignment • Small as a Pen • Self powered • Range from 700 cycles audio to over 600 megacycles u.h.f. • Output from zero to 125 v. • Low in cost • Used by Signal Corps • Write for information.

GENERAL TEST EQUIPMENT

38 Argyle Ave. Buffalo 9, N. Y.

TUNERS

AM ——— FM

For Your Favorite Amplifier. A complete line of AM, FM and AM-FM Tuner chassis. Distinctive in styling. Outstanding in performance. Features include built-in phono pre-amp. For the ultimate in listening pleasure choose tuner units backed by twenty years of electronic research and manufacturing experience.

Write for literature.

The SARGENT - RAYMENT Co.
212 Ninth St., Oakland 7, Cal.

WANTED RADIO SERVICE MEN

Experienced men with cars for part-time work on AC-DC receivers. Some traveling required. Must be bondable. Pleasant work with good compensation. Need men in or near Davenport, Iowa, Chicago, Indianapolis, Buffalo, Rochester, N. Y., Pittsburgh, Philadelphia, Washington, D. C., Baltimore, Md., and Boston, Mass.

Address box number 01
c/o Radio-Electronics
25 W. Broadway New York 7, N. Y.

SUPER-MITE RADIO

- SUPER-MITE FEATURES!**
- World's most powerful miniature radio.
 - Uses War-Born midget electronic tubes.
 - Coast-wide reception obtained.
 - Powered by midget hearing-aid battery.
 - Picture diagram for radio beginners.

PACKS AMAZING POWER!

\$3.99



Brilliant red chassis, chrome and black dial, streamlined bakelite knobs. Complete kit ready to wire as shown Only \$3.99 Post Paid. Tubes 95c each. This high quality set not available elsewhere at 10 times this price!

ELECTRONIC RESEARCH LABS.
1216 Park Row Bldg., Dept. RC, New York City 7



PHONO-AMP COMPLETE WITH TUBES.. \$4.89

PHONO-OSC COMPLETE WITH TUBES.. \$4.49

WRITE FOR LITERATURE



FM TUNER KIT
One tube experimental FM tuner. Amazing performance. Complete with tube, punched chassis and full instructions. \$2.95

SIGNAL GENERATOR
456 kc—465 kc—400 kc—1400 kc. Fully Guaranteed—Full Instructions. Complete with tubes. \$9.95 ready to use AC DC.

SIGNAL TRACER
Built-in spkr. AC DC. Highly sensitive injector circuit. Complete with tubes. \$10.95
5" dynamic spkr. New 500 ohm field, torn cones .30

YORK DISTRIBUTORS
523 Knickerbocker Ave., Brooklyn 21, N. Y.

32 FACT-PACKED PAGES



Elements of **MAGNETIC TAPE RECORDING** and 999 Applications by **A. C. SHANEY**

Only 25c **AMPLIFIER CORP. of AMERICA**
398-10 Broadway New York 13, N. Y.

EUROPEAN REPORT
(Continued from page 79)

progressive stages multiplies rather than adds.

Topping in

It is often required to "tap in" on a disc, that is, to start playing at a particular point between the beginning and the end of the record. The BBC calls this groove-locating. A clever piece of apparatus has been developed which enables the exact point required to be found with absolute precision. The reproducer has a tracking rod placed tangential to the turntable. Over this rod moves the carriage with a straight arm supporting the pick-up. Above the tracking rod is a vernier scale, showing the exact position of the carriage and the pick-up. A switch operates a lever mechanism, enabling the stylus to be lowered onto the record or raised from it at will.

The readings on the vernier scale at which the desired passage begins and ends having been noted, it is a simple matter to play just the excerpt required. The apparatus is illustrated in Fig. 2. You'll see the idea at once and it may interest and amuse you to evolve something on the same lines for your own phonograph.

Radar shipping control

A remarkable system of radar shipping control (the first of the kind in the world) has just been brought into action at Liverpool. This is one of England's most important seaports. It lies some distance upstream from the mouth of the estuary of the River Mersey and, as veterans who were there during the war may remember, there are dense fogs during the colder part of the year. Miles upon miles of docks are situated on both banks of the river at Liverpool and Birkenhead and there is always heavy traffic, not only up and down stream, but also by the cross-river ferries. Many accidents have occurred in the past and shipping has suffered heavy delays in thick weather. The radar equipment is of the scanning beam type, with PPI tube display. Five PPI tubes are used. The first gives a small-scale picture of the whole estuary and its approaches over a range of 20 miles. The next three give large-scale pictures of the same area in three sections. The fifth enables an extra-large-scale picture of any small part of the area to be obtained at will. Ships do not receive orders from the controller at the radar station, for the connin- and navigation of a ship must always be the responsibility of the captain or the pilot in charge. But indications and warnings are sent out continually by radio and a navigator can ascertain at any time not only the exact position of his own vessel, but also the positions of other vessels and of danger points. The apparatus was installed during the summer so that it might be checked and adjusted and its operators thoroughly trained under conditions of good visibility.

RADIO-ELECTRONICS for

FM-AM DETECTOR

? I want to experiment with the FM-AM detector described in the patent reviewed on page 64 of the November 1947 issue of RADIO-CRAFT. Can you supply experimental circuit constants?—J.E.G., Oceana, Va.

A. Here is the circuit with constants added. A 6SF5 a.f. amplifier has been included on the diagram. It may be necessary to experiment with the cathode choke and the resistor in the plate circuit of the 6SQ7.

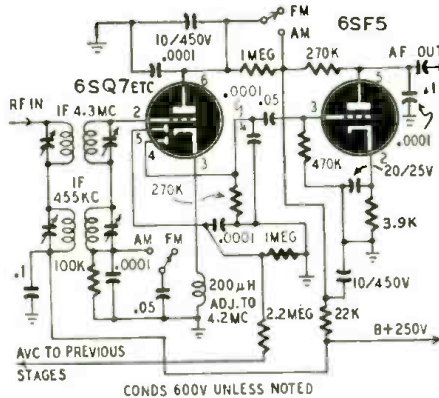

SUPERSONIC GENERATOR

? Please show a circuit of a 40-watt supersonic generator. I want to apply vibrations of various frequencies to a laboratory flask or beaker. What type transducer do you recommend?—A.M.H., Kekaha, Hawaii.

A. This supersonic generator will develop up to 40 watts at 25 kc. You can change the frequency by varying L, C1, or both. Adjust the taps on L1 for stable oscillations. A crystal transducer is recommended over the magnetostriction type because of its wider frequency range. This may be one of the Brush

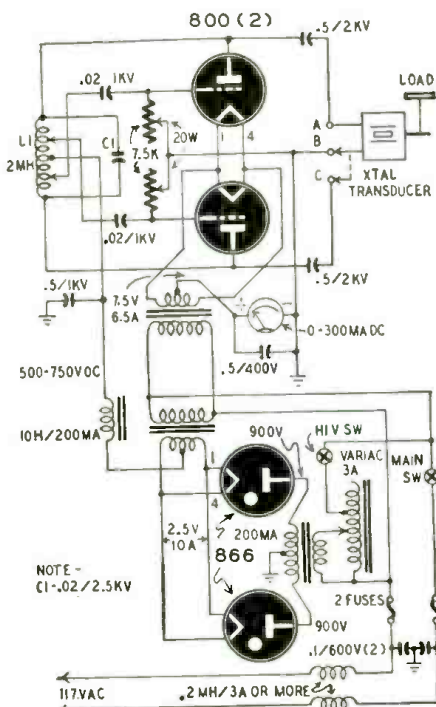

Development Co. Models AX-171, AX-178, AX-180 or equivalent. Be sure that the model you select can handle the power you develop in the generator. There are three output terminals. Connect the transducer across any two of them. The ones you use depend on the type and operating limits of the transducer.

COLOR ORGAN

? Some years ago I saw a device that converted sound to colors that changed with the frequency and amplitude of the sound. Can you supply a circuit showing how I may make one of these devices to connect to the output of my radio or phono amplifier?—J.F.G., Los Angeles, Calif.

A. The device shown was originally described in the January 1941 issue of *Electronics*. It is designed so that colored lamps respond to changes in frequency and amplitude. The lamps may be concealed behind a frosted glass or plastic panel or in frosted tubes. The arrangement is left to the ingenuity of the builder.

The device is fed by a two-channel power amplifier. Lamps, 1, 2, and 3 respond to frequency, and A, B, C, and D to amplitude. Lamps 1, 2, and 3 are connected across 234 volts a.c., developed by T3, through R1, R2, and R3. These resistors limit the current so the lamps will not light. The filaments of V1, V2, and V3 are connected across the 5-ohm tap of T1 through resonant circuits. The tubes are connected so their internal plate resistance shunts the dropping resistors. When the impedance in the filament circuits is low, the filaments heat and the plate resistance drops so that the tube passes enough current to light the lamp in series with

hallicrafters
proudly
presents
the SX-62!



\$269⁵⁰
(slightly
Higher West
of Rockies)

Communications-type
Broadcast Receiver
540 KC to 110 MC

* For discriminating listeners on all wave bands (FM/AM) . . . who appreciate the thrill of superior performance . . . with high-fidelity audio . . . who want a few extra controls but not too many.

An "SWL" version of our famous SX-42. Two stages RF, three stages IF amplification—14 tubes plus Rectifier and Voltage Regulator. See it at your local Hallicrafters dealer.

the hallicrafters co.
4401 W. FIFTH AVENUE
CHICAGO 24, ILLINOIS

the BIG 4 in TWIN-TRAX TAPE RECORDERS

Make Your Recording Dollar Go Twice as Far

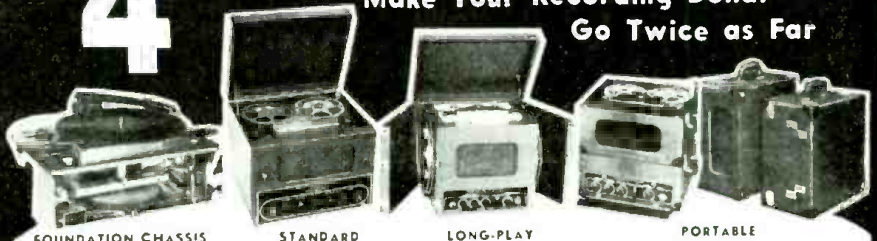

ALL TWIN-TRAX Recorders actually cut tape costs in half! The only Recorder line operating on the revolutionary principle of using two isolated and independent sound tracks on standard 1/4" wide tape. Records on one track during forward tape travel and on the other track during reverse; rewinding thus eliminated. Tape reversal is automatic and instantaneous. Mechanically and electrically, these recorders embody every design advance in the recording field. There's a model available for everyone! A basic foundation chassis for the technician;

standard one-hour-play model; an ingenious two-piece portable that divides the weight for easy carrying; and a compact long-playing model providing four continuous playing hours at high fidelity. All can be adapted for rack panel mounting. The ideal line for use in the home, laboratory, broadcast station, recording studio, etc. You can't afford to buy any Recorder until you have sent for and read full technical specifications of the revolutionary TWIN-TRAX Recorder!

*Trademark

AMPLIFIER CORP. OF AMERICA

398-10 Broadway, New York 13, N. Y.

We're GILDING the LILY!

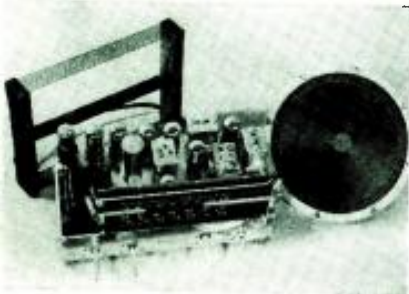

The

NEW, IMPROVED Model 7-B-1, engineered to meet YOUR needs!

Carefully engineered, and manufactured of the finest materials, the ESPEY Model 7-B-1 is specifically designed to meet the most exacting requirements for a replacement chassis, and will lend itself to any type of installation. This model is drift-compensated, AM FM, with 10 tubes plus rectifier. Supplied complete, ready to operate.

Send to DEPT. C-10 TODAY for FREE LITERATURE

ESPEY MANUFACTURING COMPANY INC.
822 EAST 77th STREET - NEW YORK 21, N.Y.

"ESTABLISHED - 1928"

RADIO MADE EASY!

A JRI Trainer

A NEW APPROACH to radio receiver repairing. Here is a METHOD of radio repairing that can be LEARNED QUICKLY—Begin repairing immediately. The electronic field is wide open. Prepare yourself for a GOOD INCOME NOW! Discover for yourself that radio repairing is EASY TO LEARN by this NEW METHOD. Send for the JRI Home Trainer TODAY. \$2.00 postpaid or plus c.o.d. charge. Satisfaction guaranteed.

THE JRI TRAINERS

P. O. Box 2091, Dept. 100, Chicago 9, Ill.

NEW POWERFUL ELECTRIC MOTOR

For Rotating Ham, FM, Television Antennas, Barbique Spits, Min. RR Turntables, Telescopes.
• Operates on 110V AC, 60-Cps. (Requires only 12MFD Cnstr.)
• Appr. 3/4 RPM—H1-Torque—No Free Swing
• Quiet
• Easy to Mount
• With Full POSTPAID INSTRUCTIONS \$5.95 CONT. USA
ALVARADIO, Dept. RC-4
907 S. Alvarado, Los Angeles 6, Cal.



it. L1 is a low-inductance choke consisting of about 1,000 turns of No. 26 enameled wire on an adjustable laminated or powdered-iron core. L2 is made the same as L1, but using only 800 turns. Vary the number of turns and position of the cores to get the most pleasing effect.

The amplitude-sensitive lamps are connected in pairs, A, B, C, and D, each letter representing two lamps. With no signal input, lamps A and B are in

series across 235 volts developed by T3. A will glow because of its lower wattage, but B will be dark. The plate resistance of V4 is in parallel with A. When the voltage across the secondary of T2 is high enough to heat V4, it passes current to lamps B and bypasses A. V5 and V6 are across taps of lower impedance than V4; therefore higher output is required to light them so they will pass current to C and D.

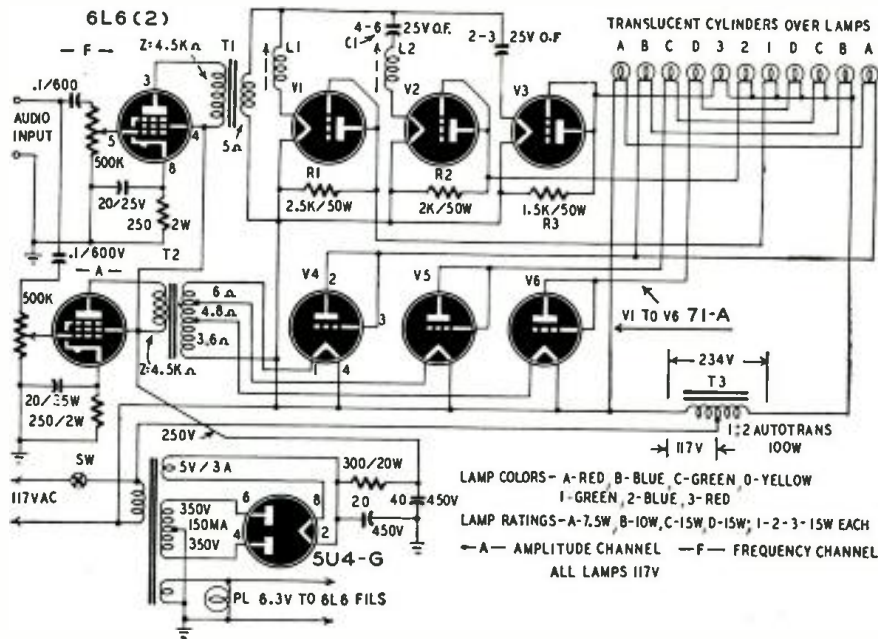

STROBOSCOPE

I would like a circuit to amplify the ticking of a watch and convert each tick to a light pulse. The watch ticks about 350 times per minute. Can this be done with a relay and strobotron?—E.C., Leamington, Ont.

A. Some types of telephone relays can follow 10 pulses per second. However, the circuit shown does not require a relay to operate. The R4350 strobotron gives a blue-white light and operates at a maximum rate of about 15 flashes per

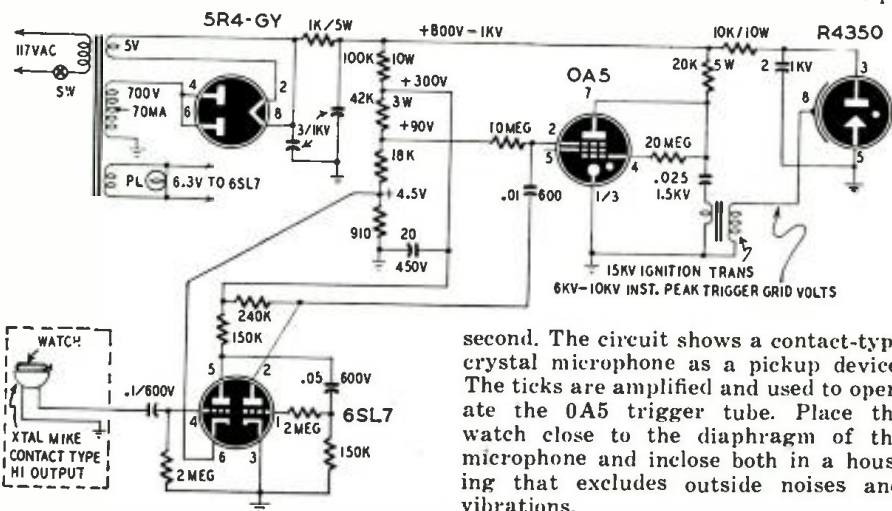

second. The circuit shows a contact-type crystal microphone as a pickup device. The ticks are amplified and used to operate the OA5 trigger tube. Place the watch close to the diaphragm of the microphone and enclose both in a housing that excludes outside noises and vibrations.

Question Box queries will be answered by mail and those of general interest will be printed in the magazine. A fee of \$1.00 will be charged for questions requiring no research or schematics. Write for estimates on questions requiring diagrams or considerable research. Be sure to give full specifications and details on the application. Due to the nominal fees charged for this work, it must be handled as a spare-time proposition. Therefore rapid service is impossible. Six to 8 weeks is required to draw up answers involving large schematics or research.

... CHECKING OSCILLATORS

Another receiver can be used to find out whether the local oscillator in an apparently dead receiver is operating.

Tune the good receiver to a frequency equal to the dead receiver's i.f. plus 550 kc and the dead receiver to about 550 kc. A beat note should be heard in the good receiver. The sets may have to be coupled fairly closely if the dead one is well shielded. It may be necessary to use capacitive coupling between the oscillator and the antenna of the good set. A 2-turn gimmick around the oscillator grid or anode may be used to couple to the antenna.

THOMAS P. MOTTLEY,
Ocean Grove, N. J.

... WESTINGHOUSE MODEL H-126

The set went on and off intermittently. One lead of the speaker voice coil is grounded to an eyelet on the speaker frame. Remove this lead and solder it directly to the speaker frame.

FLOYD D. GOFF,
Black Mountain, N. C.

... PHILCO PORTABLE MODEL 250

Hum on battery and a.c. operation can sometimes be traced to the grounded side of the volume control which is connected to the A-minus lug through a 1,000-ohm resistor. The hum is caused by a poor ground connection. Simply tighten the nut on the volume control.

BENNIE ONDRAK,
Idaho Falls, Idaho

... OUTPUT TRANSFORMERS

I had several output transformers that I could not identify. I used an a.c. voltmeter with 0-10- and 0-150 voltage ranges to determine the turns ratio and from this was able to find the impedance ratio. The characteristics of the transformer were found by the following method:

Check the transformer for shorts and grounds. Apply a known a.c. voltage to the high-resistance winding, and measure the voltage developed across the secondary. The *turns ratio* is the ratio of the voltages. The *impedance ratio* equals the square of the turns ratio,

$$(\text{turns ratio})^2 = \frac{\text{Primary impedance}}{\text{Secondary impedance}}$$

so we can find the best plate-load resistance to match the secondary impedance.

For example, a transformer develops 5 volts in the secondary with 125 volts on the primary. The turns ratio is 125/5 or 25:1. The primary impedance is the product of the turns ratio squared and the secondary impedance or 625:1 (25 x 25/1 x 1). This transformer will match the 3-ohm voice coil most efficiently to a 1,875-ohm source, (1,875/3 = 625/1). Tubes designed to work into a 2,000-ohm load, such as 25L6's and 50L6's, will work effectively.

FRANK SORENSEN,
Brooklyn, N. Y.

Mr. Radio Serviceman

ADDITIONAL \$\$\$\$ FOR YOU EVERY WEEK REPAIR ELECTRICAL APPLIANCES



The Model 40 Utility Tester comes housed in a rugged crackle finished steel cabinet with portable cover, complete with all test leads and operating instructions—only

\$15⁷⁵

WITH THE AID OF THE NEW MODEL 40

UTILITY TESTER

A NEW KIND OF INSTRUMENT FOR TESTING ALL ELECTRICAL CIRCUITS AND APPLIANCES SUCH AS—

- *RANGES *WASHERS *VACUUM CLEANERS
- *SHAVERS *FANS *AIR CONDITIONERS
- *HEATERS *MOTORS *REFRIGERATORS
- *IRONERS *TOASTERS *SUN LAMPS
- *WASHING MACHINES *ALL TYPE MOTORS FROM FRACTIONAL H.P. TO 2 H.P.

THE MODEL 40 UTILITY TESTER

Will test Thermostats under ACTUAL WORKING CONDITIONS: Will measure the ACTUAL CURRENT CONSUMPTION of any appliance either A.C. or D. C. WHILE THE UNIT IS IN OPERATION—reading will be direct in amperes—the appliance or utility may be plugged directly into front panel receptacle—a special pair of insulated clip-end leads is provided for motors; incorporates an ultra-sensitive direct-reading resistance range which will accurately measure all appliance and utility resistances down to a fraction of an ohm; Will test bulbs, fuses, condensers, field coils, etc.; Is ideal trouble shooter as it will instantly locate opens, shorts and grounds; Will locate cause of failure in three way heat control switches; will indicate when one side of an appliance or motor connected to line under test is "grounded"; Will indicate excessive leakage between a motor and a line; Will indicate when a three phase motor is running erratically due to a "blown" fuse; Will indicate whether the voltage is 110 Volts or 220 Volts, if the current is A.C. or D.C. and if the frequency is 25 cycles or 60 cycles.

GENERAL ELECTRONIC DISTRIBUTING CO. 98 PARK PLACE, Dept. R.C. 10
NEW YORK 7, N. Y.



"It's Fun to STRIP"

— WIRE —

Says Speedy

with the



Speedex

WIRE STRIPPERS

- Strip 300 ohm Twin F.M. and Television lines
- Strip all types wires sizes 8 to 30

G-C announces a new television and F.M. tool for 300 ohm twin line. It will easily strip both wires at the same time. Just place the wire between the jaws and squeeze—insulation will come off instantly without moving the wire. A great time-saver on installations.

No. 733-H Regular Twin Line Strippers \$3.60 Net
No. 744-H Automatic Twin Line Strippers \$1.80 Net

Other models available for all size wires—write for catalog Dept. D or see your Distributor.
(DISTRIBUTORS, WRITE FOR DETAILS)

Manufactured by

GENERAL CEMENT MFG. CO.
ROCKFORD, ILL. U.S.A.



NET PRICE ONLY
\$3.60
REGULAR MODEL

TECHNICAL KO's

OIL-FILLED CONDENSERS		TRANSMITTING MICAS	
.05 MFD 1000V	\$0.35	.00005	2500V \$0.15
.05 " 500V	.14	.00005	3000V .85
1 2500V	.75	.00005	5000V .85
1 " 700V	1.65	.000067	" 20
1x1 7000V	4.10	.00007	2500V .20
1.2 15000V	7.35	.00025	2500V .25
2 1800V	2.15	.00025	5000V .25
2.5 4000V	2.15	.00025	2500V .25
2.5 6000V	3.75	.00072	3000V .85
10x.25 600V	1.05	.0008	5000V .85
5 600V	.28	.0001	2500V .25
5 1000V	.40	.0011	5000V .85
5 2000V	.75	.002	3000V .20
.75 600V	.35	.003	5000V .85
.85 600V	.45	.003	3000V .65
1.0 200V	.20	.004	500V .30
2.0 600V	.40	.005	1000T.V .15
5.0 1000V	.60	.005	3000V .35
1.0 600V	.60	.005	900V .15
1.0 1000V	1.60	.008	1200V .15
1.0 220VAC	.53	.01	1200T.V .15
6.0 1000V	1.43		
8.0 600V	.85		
10.0 600V	1.75		
30.0 90V AC	1.40		
30.0 330V AC	3.75		

TUBES-CHOKE-POTS	
Tubes—5V Metal	\$0.89
Tubes—12KA Metal	.29
Choke—100MA-10H	2.10
Pots: 20K-50K-100K	1.59
Dual 1/2 Meg	.19
250K-50K	.30

25.0 Electrolytic 25V	.40
100.0 " 25V	.50

SHIELDED WIRE #22	50 Ft. for	.65
RESISTOR KIT Assorted 1/4 & 1W 100	for	1.49
BATHTUB KIT 3x1, 5, .05, ETC. 10	for	.58
CONDENSER KIT .01-.00001...100	for	2.99
MICAS .01, .002, .005, ETC. All Values	.08	
.01 150V PAPER (MIDGET)	.60	for 1.00
0.1 600V PAPER	8	for 1.00

\$2.00 min. order F.O.B. N.Y.C. Add postage 50¢ deposit, balance C.O.D. with all orders. Manufacturers Inquiries Invited. Send for Flyer. Prices are subject to change without notice.

TECHNICAL RADIO PARTS CO.

265 Greenwich St. Dept. RC-5 N.Y. 7, N.Y.

BA **EXCITING! EXCITER BARGAIN**

25 to 40 WATTS
10 to 80 METERS FOUNDATION KIT

Engineered around the BC-610 series of plug-in tuning units. Described in the 11th edition Radio Handbook. Completed exciter uses 6AG7 crystal or electron coupled oscillator, 6L6 buffer-doubler and 807 amplifier. Kit includes four tuning units (illustrated at right above with cover removed), special 5 1/4" aluminum relay rack panel, socket for plug-in units and special hardware, together with full instructions and diagrams for assembling complete exciter.
No. 31A28, FU-40 Foundation, Spec. **\$9.95**

PARTS KIT. Everything needed to complete exciter except tubes and power supply. Includes all mica condensers, resistors, RF chokes, sockets, meter switch, Q-200 ma meter, key jack, and miscellaneous parts.
No. 31A28A, Special Per Kit, Each **\$9.31**

DID YOU GET IT?
THE BIG B-A 1948 Catalog No. 481 — Everything in Radio and Electronics. Write if you have not received it. **FREE** on request.

BA **BURSTEIN-APPLEBEE**
1012-14 MCGEE STREET, Company
KANSAS CITY 6, MISSOURI

TELEVISION RECEIVER—\$1.00
Complete instructions for building your own television receiver. 16 pages—11"x17" of pictures, pictorial diagrams, clarified schematics. 17"x22" complete schematic diagram & chassis layout. Also booklet of alignment instructions, voltage & resistance tables and troubleshooting hints.—All for \$1.00.
CERTIFIED TELEVISION LABORATORIES
Dept. C, 5507-13th Ave., Brooklyn 19, N. Y.

CODE OSCILLATOR

This simple code oscillator can be used by itself, or in conjunction with another unit just like it for 2-way communication or code practice.

The circuit is that of an ordinary relaxation oscillator using a neon lamp.

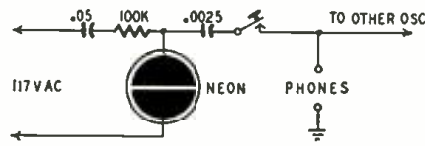

I found that the GE type NE-2 lamp worked best.

If two oscillators are used, they should be connected together as the diagram indicates.

Connect the free end of the headphones to a good ground. It may be necessary to reverse the line plug to obtain oscillation. Change the value of the .0025-uf capacitor if a different tone is desired.

JOHN V. MULLENDORE,
Boonsboro, Md.

HIGH-FREQUENCY TUNER

Here is a simple method of making a high-frequency tuned circuit. It can be used when the original coil consists of just one or two turns of wire.

Make a loop of a strip of sheet copper, the width of the strip to be determined

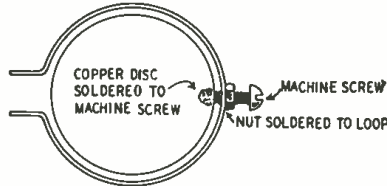

experimentally. Make a disc of the same sheet copper to fit inside the loop.

Solder a nut to the loop, as shown in the diagram, and fasten a screw to the disc. Now the disc can be turned within the loop, varying the inductance of the coil over a wide range.

R. A. CUNNINGHAM,
Newport, Ky.

2-METER TRANSCEIVER

The transceiver shown in the diagram can be fitted into a very small space. Power may be taken from a receiver or amplifier or a pair of 90-volt batteries

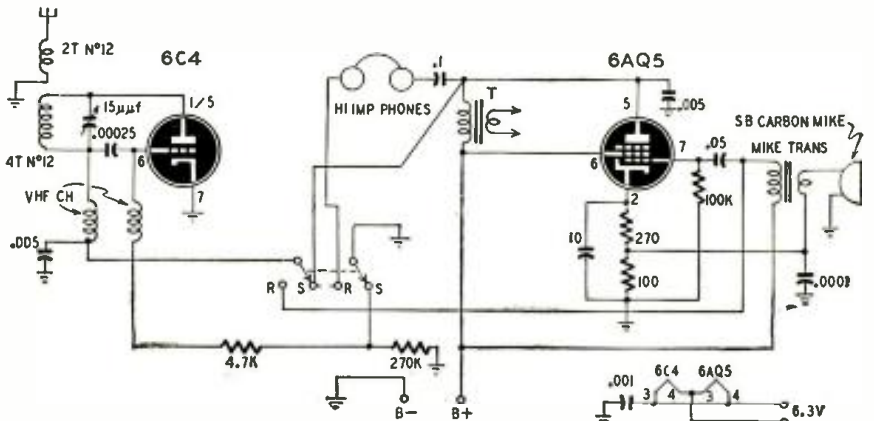

and a 6.3-volt battery can be used for portable or mobile operation.

The 6C4 is used both as transmitting and receiving oscillator. When receiving, the plate-current variations appear as a varying voltage across the mike transformer secondary and the sound, amplified by the 6AQ5, is heard in the phones.

When transmitting, the oscillator receives its plate voltage through T, which acts as a Heising modulation choke. The microphone is energized by voltage taken from the 6AQ5 cathode resistor. T is an audio output transformer, of which only the primary is used. If several transformers are in the junk box select the one which works best. An audio choke can also be used.

Adjust the coupling between the antenna and the oscillator plate coils for best results when receiving.

FRED W. CREED, VE3BUC,
Toronto, Canada

CRYSTAL PICKUP CONNECTION

The phono and microphone inputs on my amplifier are both 500 ohms. I wanted to connect a crystal pickup.

Connecting a crystal pickup through a transformer, even one with a 100,000-ohm primary, would have destroyed the low-frequency response, to say nothing of other frequencies where a resonance between the capacitive crystal and the inductive transformer might have created large peaks.

The small 1-tube amplifier shown in the diagram was the solution. The 6C5 is used as an ordinary resistance-coupled amplifier. The output, instead of being taken from the plate, is taken from a small resistor R in series with the 47,000-ohm equivalent of the follow-

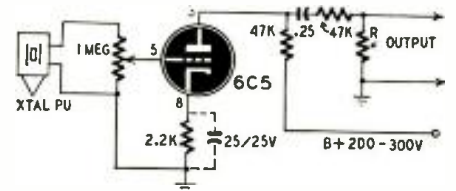

ing grid resistor. R is equal to the impedance of the amplifier input, 500 ohms in this case.

Since the output arrangement acts as a voltage divider, output voltage is less than the tube input voltage. However,

the amplifier input transformer steps it up so that a normal phono channel gives the proper gain. If higher output is wanted, use a plate-to-line transformer.

The 6C5 is mounted inside the phonograph case. A cable brings filament and plate voltages to it from the main amplifier.

ARMAND BRISSAC,
Fond-du-Lac, Mich.

1-TUBE AMPLIFIER

Here is a 1-tube phonograph amplifier with sufficient output for comfortable listening if a high-output crystal pickup

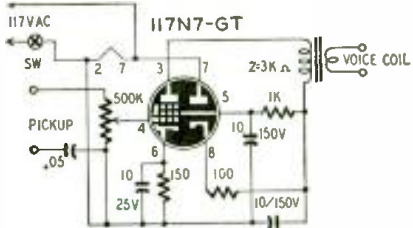

is used. No tone control was found necessary, but if one is desired, a capacitor and 1-megohm variable resistor may be placed in series between the amplifier grid and common negative.

HARRY C. AICHNER, JR.,
Erie, Pa.

A NO-LOSS EQUALIZER

When an R-C equalizer is added to an existing amplifier, its insertion loss reduces the over-all gain of the circuit. Often the amplifier does not have sufficient reserve voltage gain.

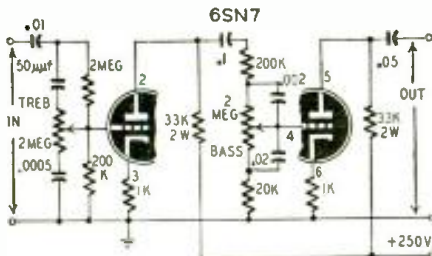

The equalizer controls both treble and bass. The equalizer controls both treble and bass. The equalizer controls both treble and bass.

This equalizer, described originally in *The Review of Scientific Instruments*, can be added to audio amplifiers without reducing the gain. As shown in the graph, it provides up to 20 db of boost or attenuation in the bass and treble channels. Both channels are controlled with logarithmic potentiometers so that

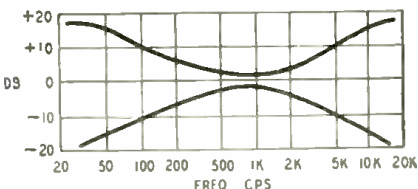

Graph shows maximum possible tone variations. the equalizer response is flat when control shafts are at mid-points in their arcs. At these settings, the insertion loss of each channel is 20 db. The losses are compensated by 20-db triode amplifiers following each network.

Insert the equalizer at a point in the amplifier where the input signal does not exceed 5 volts. This prevents overloading at maximum boost.

Are YOU Fixing Radios this New, EASY Way?



REMARKABLE NEW FEILER "STETHOSCOPE" Method Guaranteed to Lick Toughest Jobs!

SENSATIONAL—NEW! FM & TELEVISION CATHODE-RAY STETHOSCOPE—only \$89.95. Get manual for full details.

Why let old-fashioned servicing methods and equipment hamper your servicing ability? Thousands of radio servicemen—many with little experience—are already fixing radios this remarkable, "automatic" way. It's as simple as A.B.C. because Stethoscope Servicing is the newest, most basic method yet devised to simplify all repairs. Stethoscope Servicing is guaranteed to speed-up and improve your servicing ability or your money will be refunded. You owe it to yourself to find out how you, too, can begin cashing in. Stethoscopes come in a wide variety of prices from \$9.85 to \$89.95. There's a Stethoscope to meet every need. Don't delay—send coupon today.

Get This FREE New Technical Manual Today.



"The Inside Story" contains valuable hints and tips. This new complete illustrated 28-page technical manual tells the inside story of an amazing new servicing method—also contains many valuable hints and knacks for every radio serviceman. Send stamp to cover handling only manual FREE.

DON'T DELAY—GET YOUR MANUAL TODAY

FEILER ENGINEERING CO., Dept. 10RC8
945 George St., Chicago 14, Ill.
Please rush new manual "The Inside Story." I enclose stamp to cover handling.

Name
Address
City State

SURPLUS SPECIALS! ORDER NOW—BY MAIL!

- TS-11 HANDSETS* \$2.95 #
 - T-10 TUNING UNITS, New 2.50
 - RM-38 CONTROL BOX, New 2.00
 - RANGE FILTERS, New, UTC Navy Type with cord and plug 2.95
 - ARC-5 JACK BOX49 #
- BC-348 ACCESSORIES**
- COIL ASSEMBLIES, Complete
 - ANT. HF DET. New, Each \$1.29 #
 - AF. TRANS. #12 KC49 #
 - CRANK TUNING KNOB39 #
 - RL-42A REEL MOTOR & GEAR BOX* 1.95
 - AIRCRAFT GUNSHIGHT NOISE FILTER29 #
 - WE-AN-II-1 HEADPHONES, Lo-Z*98 #
 - PL-291-A PLUGS, New, 15¢ each or 7 for 1.00 #
 - GE-R1 RECEIVER COILS, 2-Band*59
 - AN-51A DIPOLE & REFLECTOR 3.95
 - EE-8 FIELD TELEPHONE* 8.95
 - AIRCRAFT KNIFE SWITCH, Hyv. Dty., 3PDT69
 - DPDT49
 - APS-13 DYNAMOTORS, New 2.95
- *Used, but good condition #Price Includes Postage

ALVARADIO Min. Order \$2.00
Dept. RC-5, 907 S. Alvarado 25% Dep. Los Angeles 6, California Bal. C.O.D.

EASY TO LEARN CODE

It is easy to learn or increase speed with an Instructograph Code Teacher. Affords the quickest and most practical method yet developed. For beginners or advanced students. Available tapes from beginner's alphabet to typical messages on all subjects. Speed range 5 to 40 WPM. Always ready—no QRM.

ENDORSED BY THOUSANDS!
The Instructograph Code Teacher literally takes the place of an operator-instructor and enables anyone to learn and master code without further assistance. Thousands of successful operators have "acquired the code" with the Instructograph System. Write today for convenient rental and purchase plans.

INSTRUCTOGRAPH COMPANY
4701 Sheridan Rd., Dept. RC, Chicago 40, Ill.

LEARN RADIO



LEARN FAST... LEARN RIGHT... AT A PRICE YOU CAN AFFORD

Easy-to-understand **BASIC TRAINING FOR BEGINNERS**
(Used by U.S. Army & Navy)
The best training costs the least! Actually, Ghirardi's famous 972-page RADIO PHYSICS COURSE book has given more Radio-Electronic beginners their start than any other book or course ever published. Contains complete basic training to fit you for a career in any phase of Radio-Electronics work. Over 300 pages make Basic Electricity easy to learn. Other subjects include 36 courses in Radio Transmission; Broadcast one giant book.

Only \$5 RADIO PHYSICS COURSE

36 courses in Radio Transmission; Broadcast one giant book. Stations; Receiving Units; Vacuum Tubes; Detection; Amplification; Photoelectric Cells; Short Waves—a total of 36 basic subjects. If broken into lessons and sold as a "course," you'll regard this big book as a bargain at \$50 or more! Over 100 illustrations. Use coupon. Read it for 5 days at our risk!

A Complete Course in RADIO-ELECTRONIC SERVICING

Learn professional service work at home!
Study now for a good job as a Radio-Electronic service repair expert! It's easy to learn from Ghirardi's 1300-page, profusely illustrated MODERN RADIO SERVICING book that costs you only \$5 complete. Covers all phases of the work. Explains service test instruments and when, where and why to use each type. Even tells how to troubleshoot all kinds of radios, analyze their circuits, test components, make all types of repairs, adjustments, installations, etc. Even explains how to start a successful radio service business. See Money-Saving Combination offer.

Only \$5 MODERN RADIO SERVICING
Learn to be a Service Expert — at home — without an instructor!

CUTS SERVICE TIME IN HALF ON 4 JOBS OUT OF 5

Whether you repair radios professionally or only work with them occasionally... **RADIO TROUBLESHOOTER'S HANDBOOK** can save you time and needless testing on almost any job! Just look up the make and model of the radio you want to fix. Book covers common troubles in over 1000 receivers by 202 manufacturers. Tells what to do—exactly how to do it. Over 300 additional pages contain charts, data, tube information codes, etc. that will help you save time, do better work in repairing any radio ever made. 711 big, manual size pages. Weighs almost 4 lbs. Use coupon. See Money-Saving Offer!

Only \$5 RADIO TROUBLESHOOTER'S HANDBOOK
NOT a "study" book!

SAVE MONEY! Let **RADIO TROUBLESHOOTER'S HANDBOOK** save you time on common service jobs! Let **MODERN RADIO SERVICING** train you for truly professional radio-electronic service work. Get both big books for special price of only \$9.50 for the two. Use coupon.

5-DAY MONEY-BACK GUARANTEE

Dept. RC-108, Murray Hill Books, Inc., 232 Madison Ave., New York 16, N. Y.

Enclosed find \$..... for books checked; or send amount plus a few cents postage. In either event, it is understood I may return books after 5 days if not satisfactory and my remittance will be refunded.

RADIO PHYSICS COURSE \$5 (\$5.50 foreign)

MODERN RADIO SERVICING \$5 (\$5.50 foreign)

RADIO TROUBLESHOOTER'S HANDBOOK \$5 (\$5.50 foreign)

MONEY-SAVING COMBINATION
Both Modern Radio Servicing and Troubleshooter's Handbook for only \$9.50 for the two (\$10.50 foreign)

Name
Address
City & Zone State

Here's a SENSATIONAL BUY!

COMBINATION INTERCOM & RADIO

Customers Say—

"Intercom alone is worth your low price. You get free a 6 tube radio in this deal plus real utility!"

A REAL MONEY MAKER FOR YOU



Intercom Sub-Station Master Intercom Station, Including 6-Tube Radio

Combines a top-quality 6 tube superhet receiver, plus office or home intercom system in handsome walnut-veneer cabinets. Hi-Amplification 3 tube intercom permits instant communication between radio-master and up to 4 remote sub-stations. Any remote station can call the master while radio is playing; call can be returned to any remote station. Operates on 110 volts AC or DC.

It's handsome—it's easy to install—it's easy to use! Price Includes Radio Master, 1 Remote, 50' wire

Original retail price was \$84.50 with 4 remotes. Buy from RSE and SAVE OVER 50%.

\$29.95

Brand new—only 400 available.

Extra Remotes—\$3.95

MIDGET I.F. TRANSFORMERS

Back again—by popular demand!



RSE scores again with a new and better I. F. 400-500 KC range—1 1/4" square x 3" high—ceramic based mica trimmers—high gain iron cores—pep up old receivers. Ideal for new construction—and now available in either input or output types—for peak performance! Individually boxed in the colorful RSE carton. List price \$2.10. LR1—input; LR2—output;

Specify Type.

Each	Matched Pair	Dozen	Egg Crate of 100
36c	69c	\$3.95	\$29.00



VOLUME CONTROLS

• Our own private brand—made by a nationally known manufacturer. • The same kind that net for \$1.09. • Noise-free carbon construction, standard shaft and bushing. • Individually boxed in our colorful carton carrying the RSE equality seal of approval. • Complete with switch, full range of sizes.

10 M ohms	100 M ohms	each	59c
15 M ohms	250 M ohms		
25 M ohms	500 M ohms	per 10	\$5.50
50 M ohms	1 Meg ohms		
2 Meg ohms		asstd.	
500 M Knurled Shaft			
500 M ohms less switch, 39c each,			100 for \$35.00

TUBES

"The All-American Five"

Here they are—the fastest movers ever made—at RSE's long discount. Brand new, tested top-grades with regular RMA guarantee. Individually boxed in eye-appealing cartons. Know your supplier—his reputation. Shoot us an order to-day—watch your profits zoom tomorrow!



125A7GT...65	125K7GT...65	125Q7GT...59
35Z5GT...49	50L6GT...65	

"All-American Kit", one each of above . . . \$2.98

ORDER INSTRUCTIONS

Minimum order—\$2.00. 25% deposit with order required for all C.O.D. shipments. Be sure to include sufficient postage—excess will be refunded. Orders received without postage will be shipped express collect. All prices F.O.B. Detroit.



Demand This Seal of Quality

RADIO SUPPLY & ENGINEERING CO., Inc.
85 SELDEN AVE. DETROIT 1, MICH.

ADJUSTING TV SETS

When I go to a customer's home to adjust a television receiver I carry a mirror with me. Most of the adjustments are on the rear of the set. I have an assistant hold the mirror as the sketch indicates so I can see the face of the

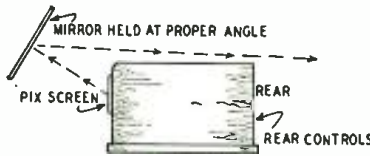

picture tube. This not only speeds up the installation process but also makes for more accurate adjustments than the usual method of going around to the front of the set after each trial setting of the controls.

H. L. FRAZIER,
Jersey City, N. J.

LINE-VOLTAGE CONTROL

Poor line-voltage regulation is a common evil in rural sections. Here is an economical and effective way to compensate for the drop in voltage which usually occurs at night.

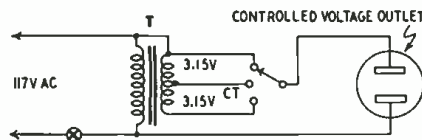

Connect a 6.3-volt filament transformer as shown in the diagram. The secondary should be rated at 1.2 amperes or higher and should be center-tapped. Rotating the selector switch will give three different voltages, the line voltage and two higher values. If the other values are lower than the line voltage reverse the connections to the secondary.

RICHARD L. PARMENTER,
Middleboro, Mass.

SPEAKER PROTECTION

Speakers are very readily damaged while being carried from customers' homes to the shop and back. To prevent tearing the cone, I carry a 13-inch-square sheet of heavy cardboard and four screws and nuts with washers. The cardboard is fastened to the front of the speaker by passing the screws through the cardboard and the speaker mounting holes. The washers are used under the screwheads to prevent the screws from pulling through the cardboard.

The few seconds necessary to attach the cardboard to a speaker will often save costly cone replacements.

ROBERT M. BOSCH,
Philadelphia, Pa.

DIAL SLIPPING

When I get a receiver in which the dial cord slips on the tuning shaft, I first remove the cord. After wrapping two thicknesses of rubber tape around the shaft, stretching the tape fairly tight, I restring the cord—and go on to the next repair. It's a sure cure!

JOSEPH A. DESBIENS,
Fall River, Mass.

Radio - Television - Electronic Parts & Equipment Specials

TELEVISION-CATHODE RAY HIGH VOLTAGE

2000 volt D.C. Power Supply
For an unbelievably low price, we can supply a completely filtered television or cathode ray 2000 volt D.C. power supply. Why bother with bulky and dangerous 60 cycle supplies or expensive R.F. power supplies when you can purchase a complete 2000 volt D.C. unit (not a kit), ready to plug into the 110 volt A.C. power line. The ridiculously low price has been made possible by a fortunate purchase of high quality components. These units are brand new, completely tested and guaranteed.

Price \$7.95

4000-6000 VOLT TELEVISION SUPPLY

Similar to the unit above, but has a much higher D.C. output voltage suitable for use with the new 7" and 10" television tubes.

PRICE \$12.50

RADIO NOISE FILTERS

Eliminates extremely noisy radio reception due to power line disturbances caused by lights, refrigerators, washing machines, vacuum cleaners, elevators, oil burners, diathermy machines, etc.

Filters out man-made noises in the broadcast, short-wave, and ultra-high frequency bands. Designed for all radios, appliances, and electrical equipment consuming up to 1300 watts (12 amperes) at 120 volts AC or DC.

Housed in a metal case 1 3/4" x 3" x 7 1/2" complete with male and female line connectors.

PRICE ONLY \$1.95

Industrial Type Radio Noise Filter—Will handle up to 50 amperes. Housed in shielded case 3 3/4" x 3 3/4" x 2 1/2".

PRICE \$3.95

EASILY ASSEMBLED RADIO KITS

5 Tube AC-DC superhet kit furnished in a brown plastic cabinet of artistic design, cabinet size (9"x5"x6")

Variable condenser tuned; with 2 double tuned I. F.'s.

Tubes used: 1-12SA7, 1-12SQ7, 1-12SK7, 1-35Z5 and 1-50L6

PRICE \$11.95 Including 5 Standard tubes

6 TUBE 3 WAY PORTABLE KIT

• For operation on 110 volt AC or DC and battery

• Superheterodyne circuit

• Full vision dial

• High gain loop

• Cabinet of Blue Aeroplane cloth finish, size 13x9 1/2 x 7"

• Tubes used 1A7, 1H5, 3Q5, 117Z6 and 2-1N5

PRICE \$13.75 Not including tubes

Extra for kit tubes \$3.75

6 TUBE, 2 BAND SUPERHET KIT

Bands covered BC 550-1600 KC and 6-18 MC

Power supply 105-125V AC, DC

Full vision dial

Variable condenser tuned, with two double tuned I. F.'s 455KC

Walnut veneer wood cabinet

PRICE \$15.75

A SCIENTIFICALLY DESIGNED PHONO SCRATCH FILTER

Resonated at approximately 4500 cycles effectively reducing objectionable needle scratch without affecting the brilliancy of reproduction.

Contains a HI-Q SERIES resonated circuit. Tested by means of an audio oscillator and an oscilloscope to give 22 db. attenuation with very low signal loss. Attenuation may be regulated by means of a SPECIAL MINIATURE gain control.

EASY TO ATTACH

Just two wires to clip on. Compact. Price \$1.65

THREE TUBE PHONO AMPLIFIER

An assembled unit ready for installation using tone and volume control and six feet of rubber cord

(Not including Tubes) Price \$2.95

With Complete Set of Tubes \$3.95

PHONO OSCILLATOR

Wireless phono oscillator transmits recording for crystal pick-ups or voice from carbon mike through radio without wires. Can also be used as an intercomm by using P.M. speaker as mike. Price \$2.95 (excluding tubes)

With Complete Set of Tubes \$3.95

SPECIAL! SPECIAL!

Mammoth assortment of radio and electronic parts, not less than TEN POUNDS of new transformers, chokes, condensers, resistors, switches, coils, wire, hardware, etc. A super-buy for experimenters, service-men, and amateurs for only \$1.25

Satisfaction guaranteed on all merchandise.

All prices F.O.B. New York City

WRITE FOR FREE CATALOGUE

RADIO DEALERS SUPPLY CO.

135 Liberty St. New York, N. Y.

Radio Thirty-Five Years Ago In Gernsback Publications

HUGO GERNSBACK

Founder

Modern Electrics	1908
Electrical Experimenter	1913
Radio News	1919
Science & Invention	1920
Radio-Craft	1929
Short-Wave Craft	1930
Wireless Association of America	1908

Some of the larger libraries in the country still have copies of ELECTRICAL EXPERIMENTER on file for interested readers.

In ELECTRICAL EXPERIMENTER, October, 1914

- Rotary Adjustable Variable Condenser by Frank H. Broome
- The Colin-Jeance System of Radiotelephony
- An Experimental Wireless Telephone by Paul Shney
- A Neat Lead-in Insulator by H. Clifford Bullard
- A Non-Inductive Potentiometer by Clifford G. Burr
- How to Make a Variable Condenser by Edgar Felix
- "Aeroplane Wireless"
- The Lieben-Reisz Gas Relay vs. the Audion
- by Eugen Reisz

INCLUDES KITCHEN SINK



This unique televiser is able to appeal to the taste, as well as the sight and hearing of the looker-in. Everything is here but the bathtub.

SIMPLE HEARING AID



Originally made for King George IV, and now demonstrated by Donna Meinzer of Zenith's hearing aid division, this 24 karat gold instrument was the most advanced modern hearing aid of 1829. It is strictly non-electronic.

OCTOBER, 1948

4 TERRIFIC BUYS!



FM and TELEVISION SWEEP SIGNAL GENERATOR \$34.95

Accurate!—Aligns FM and television receivers. Frequency range 2-227 MC. Output modulated or unmodulated. High frequency insulation throughout, built-in power line filter and special Midline capacity tuning condenser. Easy to operate—use it to adjust to new TV channels. AC only. Exceptional opportunity to purchase instrument of this kind direct from manufacturer at a tremendous saving!



AM SIGNAL GENERATOR \$32.50

8 RF bands. Frequency coverage 100 KC. 75 MC. Ultra stable 2 terminal RF oscillator, internal modulator, 3 step RF attenuator, Cathode follower output tube, AC only. An indispensable service shop instrument.



2-WAY INTERCOM SYSTEM \$14.95

Master and sub in black plastic with 50 feet of cable. Has 4" PM speaker and 3 tube amplifier. 105-125 Volts, AC-DC (Formerly priced at \$37.50)lots of 6—\$12.95

DYNAMOTOR \$5.95

For transmitters of Public Address Outlets, Mobile or Yacht Installations. Output 500 Volts at 200 MA continuous or 400 MA intermittent. Input 12 or 24 Volts, DC. Type 1P315AX; power supply for BC223.



Backed by ECA with RMA Guarantee

- Enclosed find check (or money order) in full
- 20% deposit, bal. CDD for the following:
- Send me FREE ECA Bargain Bulletin
 - FM Sig. Generator \$34.95 Dynamotor \$5.95
 - AM Sig. Generator \$32.50 Intercom \$14.95

Name

Address

City Zone State

ELECTRONIC CORP. OF AMERICA
353 W. 48th St. New York 19, N. Y.

FOR LEOTONE VALUES!

SAVE ON TUBES! STOCK UP NOW at up to 80% off list. Perfect condition, unsealed cartons. Most types in stock—ALL GUARANTEED FOR 90 DAYS!

27, 35, 36, 37, 39, 77, 84, 85, 89, 5W4, 5Y3, 5Z3, 6110, 6K7, 6L7 or 6X3	39c
24, 75, 76, 78, 5Y4, 5Y3, 5Y4, 1A7, 1L6, 6A1, 6A7, 6H7, 6C5, 6F5, 6G5, 6L5, 6K9, 6L9, 6S7, 6S17, 6S17, 6SK7, 6H7, 7A7, 7B8, 7Y1, 12SK7 or 50H5	49c
Miniature (1" sq. x 2 1/4")	Per 100 \$.98
GT size (1 1/4" sq. x 3 1/4")	Per 100 " 1.25
Medium (1 1/2" sq. x 4 1/4")	Per 100 " 1.49
Large (2" sq. x 5")	Per 100 1.79

WIRE RECORD-PLAYBACK HEAD—Precision built. Triple-coil (record, playback, erase); 4-pin plug-in type. Moulded bakelite housing (1 1/4" x 1 1/2" x 7/8"), accurately "V" grooved for maximum fidelity & sensitivity. For replacement of new applications.

WIRE HEAD SOCKET—Polarized, moulded bakelite. Fully shielded.

\$6.95

Only 35

Here's a Terrific Item . . . **POWER CONTROL UNIT**—25 watt-350 ohm rheostat, mtd. in weather-proof metal case, (3 1/2" sq. x 3 1/2"), Ceramic insul. bronze potentiometer knob. Shpg. wt. 4 lbs. . . . 98

"OUNCER" OUTPUT TRANSFORMER (7/8" x 1 3/16") 2000 ohm tapped double primary in wire coil. Excellent with Beam Power type tubes. 12 for 5.00

UNIVERSAL AUTO SUPPRESSORS for spark plug or distributor. Elbow type . . . ea. .07 18 for 1.00

SOMETHING NEW . . . Brand new precision made unit containing: miniature, 3 1/2 meg. output choke (2500 ohms DC); resistors, condensers, etc. All on bakelite chassis 2" x 2 1/2" x 1/2".

HEARING AID SUB-ASSEMBLY Only . . . \$1.49

RECEIVED YOURS YET? Supplements listed below are FREE. FOR THE ASKING. Write today for any that interest you.

- "RECORDING & COMPONENTS & ACCESSORIES"
- "HEARING AID & MINIATURE PARTS"
- ALNICO MAGNETS
- "RADIO & ELEC. TRONIC COMPONENTS"

RHEOSTAT SPECIALS!!

All famous makes:

- 1/4" shafts.
- 2 1/2 watt — 250 ohms. 39c
- 6 for 1.98
- 50 watt — 15 ohms. 98c
- 6 for 5.00
- 100 watt — 75 ohms. ea. 2.49

CRYSTAL MICROPHONE, Sensitive diaphragm type. Small size (1 3/4" O.D., 1 1/4" deep) ideal for REGULAR or CONTACT MIKE or as PILLOW SPEAKER. Rubber shock-mtd. metal frame. Less housing. . . . ea. 98

ALNICO MAGNETS—EXPERIMENTAL KIT containing 10 ass'd. powerful Bar, C, U, Circular, Block, etc. for every purpose. . . . 1.98

LEOTONE'S "JUMBO RADIO PARTS KIT"

BIGGER & BETTER THAN EVER!!!

Yes, the NEW "JUMBO RADIO PARTS KIT" HAS PROVEN ITS VALUE to hundreds of Radio-men—17 FULL POUNDS of new & dismantled radio & electronic parts—COILS, TRANSFORMERS, WIRE, SPEAKER REPAIR PARTS, RESISTORS, CONDENSERS, KEY, HARDWARE, etc., etc. All these and MUCH MORE \$2.95 for only (Shipping weight 21 lbs.)

RCA VICTOR POWER TRANSFORMERS for models R-32, 45, 52 or 75. Unshielded. Shpg. wt. 7 lbs. \$5.95

110V. AC MOTOR, Approx. 1750 RPM. Shaded pole. Frnt. H.P. Quiet operating for Record Players, Blow-ers, etc. 3 1/2" shaft. Overall: 2 1/4" x 2 1/4" x 1 1/2". Shpg. wt. 2 lbs. . . . 1.29

Min. Order \$2.00. 20% Deposit Req. on all COD'S PLEASE ADD SUFFICIENT POSTAGE . . . EXCESS REFUNDED

LEOTONE RADIO CO.

MAKERS OF CONES AND FIELD COILS
65-67 DEY STREET, NEW YORK 7, N.Y.
WORTH 2-0284-5
12,000 SQ. FT. OF RADIO PARTS

EVERY SERVICEMAN
CAN afford
SUPERIOR
TEST-EQUIPMENT

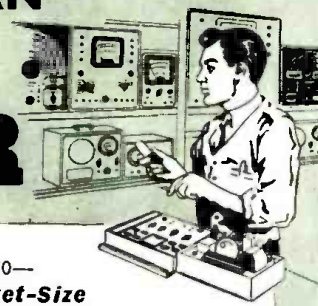

THE NEW MODEL 770—
**An Accurate Pocket-Size
VOLT-OHM MILLIAMMETER**
(SENSITIVITY: 1000 OHMS PER VOLT)

Features:

- Compact—measures 3 3/4" x 5 3/4" x 2 1/4".
- Uses latest design 2% accurate 1 Mil. D'Arsonval type meter.
- Same zero adjustment holds for both resistance ranges. It is not necessary to readjust when switching from one resistance range to another. This is an important time-saving feature never before included in a V.O.M. in this price range.
- Housed in round-cornered, molded case.
- Beautiful black etched panel. Depressed letters filled with permanent white, insures long-life even with constant use.

Specifications: 6 A.C. VOLTAGE RANGES: 0-15/30/150/300/1500/3000 volts.
6 D.C. VOLTAGE RANGES: 0-7 1/2/15/75/150/750/1500 volts.
4 D.C. CURRENT RANGES: 0-1 1/2/15/150 Ma. 0-1 1/2 Amps.
2 RESISTANCE RANGES: 0-500 ohms. 0-1 Megohm.

The Model 770 comes complete with self-contained batteries, test leads and all operating instructions.

\$13.90
NET

We manufacture a complete line of radio test equipment. Write Dept. RC-10 for FREE catalog today!

MFD. BY



SUPERIOR INSTRUMENTS CO.

227 Fulton St., New York 7, N. Y.

at your regular jobber

Collins Announces:
COLLINS CUSTOM COMPONENTS

A complete high fidelity radio receiving system from antenna to loud speaker matched by engineers.

FM — AM — TV — PHONO

Matched units—May be purchased separately or as a complete package—Add-a-unit system

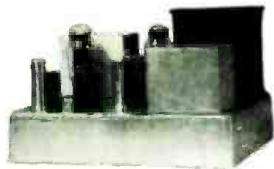
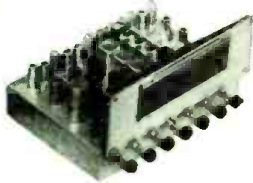

THE COMPLETE SYSTEM COMPRISES:

1. New, improved Collins 19 tube FM/AM tuner with Bass and treble tone controls, FM squelch, Pickup equalizer tube.
2. High fidelity amplifier (12 watts, triode output)
3. Record Changer (intermix, with G.E. cartridge)
4. 12" P.M. speaker (wide range)
5. Antenna system (for FM and TV)
6. Transcription player (dual-speed, precision arm)
7. Television chassis (12" and 15" screen)

Write for interesting brochure describing this wonderful equipment. Learn how you may obtain the very finest radio receiving equipment—all from one source. No more hap-hazard purchasing of different makes of equipment with matching problems. COLLINS CUSTOM COMPONENTS are matched at the factory for top-notch, efficient operation. You will save money too.

COLLINS AUDIO PRODUCTS CO., INC.

P. O. BOX 368

Phone WE-2-4390

WESTFIELD, N. J.

HARMONIC GENERATOR

Patent No. 2,443,094

Wendell L. Carlson and

Hugh L. Donley, Princeton, N. J.

(assigned to Radio Corp. of America)

These inventors use a nonlinear ceramic condenser to generate r.f. harmonics. The element may be 80% barium titanate oxide and 20% strontium titanate oxide. This dielectric is coated with metal electrodes. The unit may be about 1.5 mils thick and 5 mils in diameter. Such a condenser has almost no resistive component so

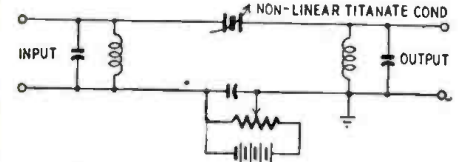

there is negligible power loss. Its nonlinear transmission produces harmonics.

The ceramic capacitor is used to couple two resonant circuits. The input is tuned to the fundamental, and the output to the desired harmonic. A battery and bypass condenser are also connected between the circuits. The capacitance varies with the voltage across the ceramic unit. When the d.c. bias is set to zero, only odd harmonics can be generated because both halves of the wave are affected equally. With the application of d.c. bias, the r.f. current becomes nonsymmetrical and even harmonics are generated. The bias may be set to optimum for the desired harmonic.

PHASE SHIFT

Patent No. 2,442,097

Stuart W. Seeley, Roslyn Heights, N. Y.

(assigned to Radio Corp. of America)

Out-of-phase currents into a goniometer coil system are generated by this system. The two coils L in Fig. 1 are fixed and at right angles to each other. Currents through them must be

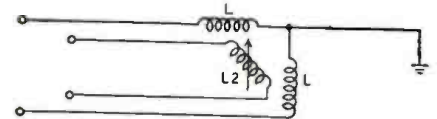

Fig. 1—Coils L are fixed. L2 may be rotated.

90 degrees out of phase. The movable coil L2 is coupled to the others. When it is rotated, there is more coupling to one fixed coil and less to the other.

The bridge circuit in Fig. 2 is the general schematic of this invention. The two fixed, similar goniometer coils are shown as L and their internal resistance as R_i. The two condensers C are equal and the resistors R are also equal. Calculation shows that, under these con-

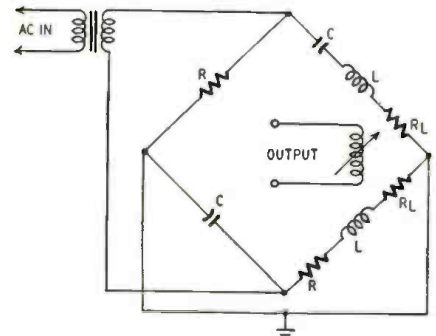

Fig. 2—Bridge shows theory of the invention.

ditions, ambient temperature variation may change the Q of the coils, but does not affect the phase of currents through L. This is very important in precise systems such as shoran and loran.

PULSE TIMING

Patent No. 2,442,769

David E. Kenyon, Smithtown, N. Y.

(assigned to Sperry Corp.)

Pulses controlled by an R-C circuit are not as reliable as those controlled by a tuned circuit containing inductance and capacitance. However,

RADIO-ELECTRONICS for

accurate timing can be provided by coupling a multivibrator to a resonant circuit as is done here.

V1 and V2 in Fig. 1 are the multivibrator tubes. They feed into a cathode-follower stage V3 which includes the parallel tuned circuit L-C1. This controls the multivibrator input. Resistor R is used only to limit plate current of V3. Initially V1 conducts because it has no

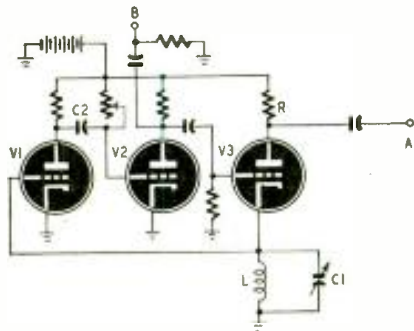

Fig. 1—The LC circuit serves to time pulses.

grid bias. The large V1 plate current produces a negative pulse through C2 at the V2 grid, cutting off this tube. V3, in turn, conducts. A short time later (shown as t1 in Fig. 2) condenser C2 has discharged enough to permit V2 to conduct and to cut off V3. At this instant a positive pulse with a flat top appears at terminal A. At the same time a differentiated pulse may be taken from B.

The abrupt drop in V3's current induces a large negative voltage across L-C1 and therefore causes V1 to cut off. The tuned circuit tends to oscillate at its resonant frequency. After a half-cycle, however, the V1 grid returns to zero and starts to go positive. This places a low-re-

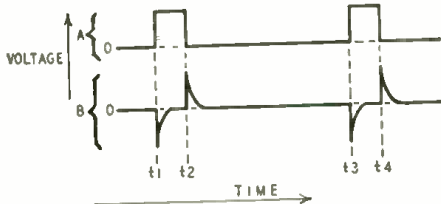

Fig. 2—Pulses which appear at the terminals.

sistance shunt (grid-cathode circuit of the tube) across the tuned circuit and damps out oscillations. As V1 conducts, V2 cuts off and V3 conducts. At this time (t2 in Fig. 2) the flat-topped pulse ends.

After a definite interval, condenser C2 is discharged enough to permit V2 to conduct again. This is time t3. Now the previous cycle repeats itself.

The duration of the flat-topped pulses is governed by a tuned circuit and all pulses are exactly the same. Duration between pulses is controlled by the discharge time required for the capacitor C2.



Suggested by:
E. R. Donohue, Walla Walla, Wash.

"Don't mind me Lady—I'll have this radio fixed in a jiffy."

OCTOBER, 1948

Lightest Most Efficient Crystal Pickup Cartridge Ever Conceived!

ACTUAL SIZE →



← WEIGHS ONLY $\frac{1}{5}$ OZ.

NEW
SERIES 12



BETTER COUPLING OF RECORD GROOVE TO CRYSTAL

Exclusive Electro-Voice development now brings amazing improvement in record playing . . . *outmodes existing crystal pickup cartridges* . . . opens up vast new replacement opportunities. Fully tested and proved . . . the new Series 12 TORQUE DRIVE provides a more rugged cartridge for everyday use in home phonographs, booth demonstrators, and coin-operated machines. Assures finer reproduction, less surface noise, less needle talk, less record wear, longer record life, more needle plays!

3 BASIC MODELS REPLACE OVER 100 STANDARD TYPES

Comes in low, medium and high voltage outputs to provide universal replacement. Speeds servicing, steps up your profit. Installation is simple. Each cartridge is furnished with replaceable Osmium-tip or Sapphire-tip long-life whisker needle. It is available individually or in kits.

Series 12 with Osmium-tip needle. List price, \$7.50
Series 12 with Sapphire-tip needle. List price, \$8.50

Ask your E-V Distributor, or send now for
Bulletins 141 and 142

ELECTRO-VOICE, INC., BUCHANAN, MICH.
Export: 13 East 40th St., New York 16, U.S.A.
Cables: Arlab

New MICROGROOVE Model L-14 TORQUE DRIVE Crystal Cartridge now available—at same price.
New Model 20 MAGNETIC Pickup Cartridge also available for REGULAR or MICROGROOVE records. Uses matching Transfilter.

ANOTHER FIRST BY

Electro-Voice

Edited By **ELMER R. FULLER**



**SOUND EQUIPMENT,
SOUND VALUES
IN RADIONIC'S
FREE CATALOG**

MONEY SAVING PRICES

On all Public Address and Inter-communicating Equipment

**NEW!
WEBSTER-CHICAGO**

33 1/3 RPM Record Changer for new Columbia type microgroove long playing records. With base. Similar in appearance to Model 55. Model No. 133—
Your Price **\$38.75**

For 33 1/3 and 78 RPM. With automatic stop. Similar to Model 156. Plays new and old type records. Model No. 266.
Your Price **\$34.60**

Model 246. Similar to Model 256 above but less automatic stop.
Your Price **\$29.85**

FREE



CHOCK FULL OF BUYS!

RADIONIC EQUIPMENT COMPANY
170 NASSAU ST., NEW YORK 7, N.Y.

Tribune Theatre Entrance
Tel. WOrk 2-0421 • Cable "CHANSOR"

RADIONIC EQUIPMENT CO., Dept. 1010
170 Nassau Street, New York 7, N.Y.

Send at once your free catalogs, supplements and bargain lists as published—listing products of leading manufacturers of radio-electronic parts and equipment.

NAME
P.O. BOX or STREET
TOWN STATE.....

MAIL TODAY!

UNUSUAL OFFER Basic 'Scope Kits!

Use for oscilloscopes—modulation monitors—television repeaters—experimental jobs. Buy complete at special savings or any item separately at these bargain prices

3" TUBE KIT

HERE'S WHAT YOU GET

- 1—Power Transformer: Pri-115/230V 50-70 cts Sec-500V CT/55ma, 325V/1.5ma, 2.5V/1.75A, 6.4V/6A, 6.4V/3A \$5.25
- 2—Filter Chokes: 8 Hy. 110ma \$1.25 ea. 2.50
- 1—Conn. 2x.25mf, 2000V DC oil filled 1.25
- 3—Cond. 4mf, 600V DC oil filled 60c ea. 1.80
- 1—3HP-1 Cathode ray tube 2.50
- 1—Diheptal socket for 3HP-135

\$13.65

Yours Complete at ONLY **\$9.95**

5" TUBE KIT

- 1—H.V. Power Transformer: Pri-115/230V 35-60cps Sec-1200V/2ma, 2.5V/1.75A, 6.4V/6A, 6.4V/3A \$5.50
- 1—L.V. Power Transformer: Pri-115/230V 35-60cps Sec-500V CT/110ma, 6.5V/1A 4.75
- 2—Filter Chokes: 8 Hy 110ma \$1.25 ea. 2.50
- 1—Cond. 2x.25mf, 2000V DC oil filled 1.25
- 3—Cond. 4mf, 600V DC oil filled, 60c ea. 1.80
- 1—5CP-1 Cathode ray tube 3.50
- 1—Socket for 5CP-135
- 1—Clip for 5CP-1 third anode25

\$19.90

COMPLETE ONLY **\$14.50**

SCOOP PACKAGE

6—3HP-1 Cathode Ray Tubes—New—In original cartons. **A BUY at \$9.60**
Minimum order—\$9.60. 25% deposit with order required for all C.O.D. shipments. Be sure to include sufficient postage—excess will be refunded. Orders received without postage will be shipped express collect. All prices F.O.B. N. Y. City.

S. KLEINMAN

96 Gold St. New York 7, N. Y.

WELL, fellas, you asked for it, and here it is. I've got a job to do, a BIG job, and I need your help to put it over. In the future, this department will be published in two installments. Then we will skip one issue, in which the FM station list will appear. The station list will thus be printed complete in two issues instead of three as in the past. Now then, here is what we have to do: show that the readers of this magazine really want this department, that they are reading it, enjoying it, and wish to see it not only continued, but enlarged to its pre-war status. Many of you will remember this department when it was called "On the Ham Bands" and will remember the features of that era. Well, we are going to put those same features back into print again. I have been looking over some of the station lists of those days, and the old ideas are gradually taking shape again. Several of them will be put into use in future issues. Pictures? Yes, we want pictures of listening posts, rare verification cards, and the like. Here is where your help comes in. Send reports on your shortwave activities, and any information you may have on schedules and frequencies. If you have good up-to-date photos of listening posts, good verification cards send them to us and we will give the sender full credit if they are used, and will see that they are safely returned to the lender, if he informs us that they are desired.

Recently we received a new book which was published recently in Denmark. It is known as "The World-Radio Handbook for Listeners." This is the best book of its kind that I have ever seen, and I heartily recommend it to all of our readers. It gives information on

world shortwave stations that can be found in no other volume in as complete a form. It is to be printed twice a year and the third edition will be published in November.

SEAC, in Colombo, Ceylon, is now being heard weekdays from 2330 to 0130 on 15.120 mc. Other programs are heard on 9.520 and 17.730 mc, but we do not have the schedule of these transmissions from Ceylon.

The Danish station is now being heard on 15.165 mc from 0900 to 1100, EST, and reports of reception will be very much appreciated. They may be sent direct to the station at Rosenorssalle 22, Copenhagen, Denmark. Reports will be answered by letter from the director of the shortwave department.

The State of Israel is being heard very well on the east coast several times each day. The present schedule is from 2155 to 2245; 2400 to 0015; 0330 to 0500; 0600 to 0615; and 0930 to 1345. The frequency in use is 6.840 mc.

If you want a really neat card to put in your collection, listen for ZQP on 3.910 mc from 1000 to 1200. The announcements are in English on Mondays and Saturdays. The quarter-hour time interval is the beating of African drums. Other frequencies used are 7.220 megacycles and 9.700 mc.

Let's hear from you, and give us the help we need to put this department in the number one spot of RADIO-ELECTRONICS. My boss tells me that if I can supply any *really good* material he can find space to publish it. This removes the war-imposed barrier of lack of space, and gives us a wide-open challenge. So, you can see, your editor is in need of help from the readers, and here's hoping that they make good for him—Hi!

Freq.	Station	Location and Schedule	Freq.	Station	Location and Schedule
2.500	WWV	WASHINGTON, D. C.; U. S. Bureau of Standards; continuously	4.810	HJBB	CUCUTA, COLOMBIA; 1700 to 2200
3.310	YV1RO	TRUJILLO, VENEZUELA; 1700 to 2130	4.820	XEJG	GUADALAJARA, MEXICO; 2200 to 2100
3.340	UD3	DELHI INDIA; 1200 to 1245	4.820	HJEO	CALI, COLOMBIA; 1900 to 2200
3.370	YV1RT	MARACAIBO, VENEZUELA; 1730 to 2230			
3.380	YV5RY	CARACAS, VENEZUELA; 0930 to 2230			
3.390	YV4RK	MARACAY, VENEZUELA; 1800 to 2230			
3.390		COLOMBO, CEYLON; 0730 to 1200			
3.400	YV5RW	CARACAS, VENEZUELA; 0530 to 2230			
3.420	YV2RC	MÉRIDA, VENEZUELA; 1800 to 2130			
3.440	YV1RU	MARACAIBO, VENEZUELA; 1900 to 2130			
3.460	YV4RP	VALENCIA, VENEZUELA; 1730 to 2130			
3.480	YV4RQ	PUERTA CABALLO, VENEZUELA; 1700 to 2130			
3.480	ZQ1	JAMAICA, BRIT. WEST INDIES; 1400 to 2200			
3.490	YV3RS	BARQUISIMETO, VENEZUELA; 1630 to 2130			
3.500	YV5RX	CARACAS, VENEZUELA; 0930 to 1400; 1530 to 2230			
3.510	YV6RC	BARQUISIMETO, VENEZUELA; 1800 to 2130			
3.530	YV5RS	CARACAS, VENEZUELA; 0530 to 2230			
3.910	ZQP	LUSAKA, SOUTHERN RHODESIA; 1000 to 1200			
4.040		PONTA DEL GADA, AZORES; 1500 to 1900			
4.100	HCJB	QUITO, ECUADOR; 1800 to 2230			
4.700	ZQ1	KINGSTON, JAMAICA; 1630 to 1830			
4.750	YV1RV	MARACAIBO, VENEZUELA; 0530 to 2130			
4.770	YV1RY	CORO, VENEZUELA; 1600 to 2130			
4.780		SINGAPORE, MALAYA; 0345 to 1000; 2130 to 0130			
7.780	YV4RO	VALENCIA, VENEZUELA; 1630 to 2130			
4.780	HJAB	BARRANQUILLA, COLOMBIA; 1700 to 2255			
4.790		BANDJENG, NETHERLAND EAST INDIES; 0730 to 0800			
4.810	YV1RL	MARACAIBO, VENEZUELA; 0530 to 2230			



Suggested by Arthur Trauffer, Council Bluffs, Iowa

"The Unfinished Symphony."

RADIO-ELECTRONICS for

- 4.830 YV2RN SAN CHRISTOBAL, VENEZUELA: 100 to 2130
- 4.840 YV1RZ VOLERA, VENEZUELA: 1630 to 2145
- 4.850 HJCA BOGOTA, COLOMBIA: 1900 to 2200
- 4.860 PRCS BELEM, BRAZIL: 0600 to 0700; 0900 to 1100; 1530 to 2600 except Sundays
- 4.880 HJFH ARMENIA, COLOMBIA: 0600 to 2200
- 4.890 HJCH BOGOTA, COLOMBIA: 1800 to 2200
- 4.900 ZOH COLOMBO, CEYLON: 0430 to 1145
- 4.920 CR7BU LOURENCO MARQUES, MOZAMBIQUE: 1330 to 1600; Sundays, 1000 to 1500
- 4.920 YV5RN CARACAS, VENEZUELA: 0600 to 2230
- 4.920 HJAP CARTAGENA, COLOMBIA: 0600 to 1300; 1700 to 2200
- 4.940 HJCV BOGOTA, COLOMBIA: 0645 to 1115; 1600 to 2315
- 4.950 HJCV BOGOTA, COLOMBIA: 1000 to 1400; 1700 to 2300
- 4.960 HJAE CARTAGENA, COLOMBIA: 1600 to 2230
- 4.970 YV5RM CARACAS, VENEZUELA: 0530 to 2230
- 4.990 YV3RN BARQUISIMETO, VENEZUELA: 1630 to 2230
- 5.000 WWV WASHINGTON, D. C.: U. S. Bureau of Standards; continuously day and night
- 5.810 MOSCOW, U.S.S.R.: schedule unknown
- 5.840 PZH5 PARAMARIBO, SURINAM: 1800 to 2145
- 5.870 HRN TAGUCIGALPA, HONDURAS: 0800 to 1000; 1300 to 1500; 1800 to 2300
- 5.880 ZRK CAPE TOWN, SOUTH AFRICA: 2345 to 0130; 1100 to 1600
- 5.980 ANDORRA: 0800 to 0830; 1300 to 1900
- 5.990 MOSCOW U.S.S.R.: 0800 to 1645
- 5.990 OAX4Z LIMA, PERU: 1630 to 2330
- 5.910 OZX4V LIMA, PERU: 1800 to 2400
- 5.950 HH2S PORT-AU-PRINCE, HAITI: 0600 to 0815; 1100 to 1300; 1730 to 2130
- 5.950 RV15 MOSCOW, U.S.S.R.: 2300 to 1000
- 5.970 HJ1 VATICAN CITY: 1000 to 1100
- 5.980 LRS1 BUENOS AIRES, ARGENTINA: 1800 to 2300
- 6.000 ZFY GEORGETOWN, BRITISH GUIANA: 0745 to 0745; 0945 to 1145; 1415 to 1945
- 6.000 CFCX MONTREAL, CANADA: 0700 to 2315
- 6.000 HPSK COLON, PANAMA: 0730 to 2300
- 6.010 ZRH JOHANNESBURG, SOUTH AFRICA: 2345 to 0130; 0900 to 1100
- 6.010 CJCX SYDNEY, NOVA SCOTIA: 0530 to 2200
- 6.020 HJCV COLOMBO, CEYLON: 1930 to 1200
- 6.020 HJCV BOGOTA, COLOMBIA: 0700 to 0800; 1400 to 2315
- 6.020 XEUW VERA CRUZ, MEXICO: 0700 to 0100
- 6.020 FZ1 BRAZAVILLE, FRENCH EQUATORIAL AFRICA: 1800 to 1845; 0000 to 0130
- 6.020 PGD HILVERSUM, NETHERLANDS: 1745 to 2300; Tues. 0300 to 0430; Wed. & Sat. 1030 to 1200; 1600 to 1730
- 6.030 MOSCOW, U.S.S.R.: schedule unknown
- 6.030 CFYP CALGARY, CANADA: 0730 to 0100
- 6.030 HPSB PANAMA CITY, PANAMA: 1800 to 0030
- 6.040 RA00N BURMA: 0915 to 1015
- 6.040 COBF HAVANA, CUBA: 0800 to 2300
- 6.040 XETW TAMPICO, MEXICO: 0745 to 0045
- 6.040 WRUS BOSTON, MASSACHUSETTS: 1900 to 2230
- 6.060 TETUAN, SPANISH MOROCCO: 0230 to 0300; 1330 to 1500
- 6.060 KNBA DIXON, CALIFORNIA: 0130 to 1005
- 6.070 GRR LONDON, ENGLAND: 2300 to 0030
- 6.070 CFRX TORONTO, CANADA: 0600 to 0030
- 6.080 CKFX VANCOUVER, CANADA: 0930 to 0300
- 6.080 Munich MUNICH, GERMANY: 1100 to 1700
- 6.090 LRY1 BUENOS AIRES, ARGENTINA: 0645 to 2200
- 6.090 LUXEMBOURG: 0010 to 0030; 1400 to 1630
- 6.090 CBFW MONTREAL, CANADA: 0730 to 1945; 2000 to 2100
- 6.090 ZYB7 SAO PAULO, BRAZIL: 1600 to 2150
- 6.100 VUD3 DELHI, INDIA: 1200 to 1245
- 6.100 PRE9 WARSAW, POLAND: 1100 to 1800
- 6.110 GSL FORTALEZA, BRAZIL: 0900 to 1200; 1600 to 1900
- 6.120 HP5H LONDON, ENGLAND: 2300 to 0215; 1015 to 1215
- 6.130 XEUZ PANAMA CITY, PANAMA: 0630 to 2400
- 6.130 CHNX MEXICO CITY, MEXICO: 1500 to 0030
- 6.130 CHNX HALIFAX, NOVA SCOTIA: 0700 to 2000
- 6.130 COCD HAVANA, CUBA: 0700 to 2100
- 6.140 HJDE MEDELLIN, COLOMBIA: 1100 to 2300
- 6.150 GRW LONDON, ENGLAND: 1515 to 1600; 2000 to 2215
- 6.150 CKRO WINNIPEG, CANADA: 2300 to 0300
- 6.150 EOB TEHRAN, IRAN: 0930 to 1400; 2230 to 2315
- 6.150 TIRH SAN JOSE, COSTA RICA: 2130 to 2400
- 6.150 CS2WD LISBON, PORTUGAL: 1330 to 1800
- 6.160 HJCD BOGOTA, COLOMBIA: 0700 to 0800
- 6.160 CBRX VANCOUVER, CANADA: 0900 to 0200
- 6.160 HHCM PORT AU PRINCE, HAITI: 0500 to 0830; 1100 to 1400; 1700 to 2145
- 6.160 HER3 BERNE, SWITZERLAND: 0245 to 0715; 1200 to 1700; 2030 to 2230
- 6.200 HJCT BOGOTA, COLOMBIA: 1000 to 1400; 1800 to 2315
- 6.200 YV6RD CIUDAD BOLIVAR, VENEZUELA: 1500 to 2315
- 6.200 FK8AA NOUMEA, NEW CALEDONIA: 0200 to 0400; 0430 to 0500
- 6.230 HRD2 LA CEIBA, HONDURAS: 1200 to 1400; 1900 to 2300
- 6.330 COCW HAVANA, CUBA: 0600 to 2400
- 6.240 HJCF BOGOTA, COLOMBIA: 1700 to 2300
- 6.240 HJIN CIUDAD TRUJILLO, DOMINICAN REPUBLIC: 1600 to 2230
- 6.280 HCJB QUITO, ECUADOR: 1800 to 2400
- 6.310 HJ1Z CIUDAD TRUJILLO, DOMINICAN REPUBLIC: 1600 to 2255
- 6.360 HRP1 SAN PEDRO SULA, HONDURAS: 1100 to 1415; 1800 to 2330
- 6.370 CSX LISBON, PORTUGAL: 1230 to 1800
- 6.450 COH1 SANTA CLARA, CUBA: 0630 to 2400

(Continued on following page)

OPPORTUNITY AD-LETS

Advertisements in this section cost 25c a word for each insertion. Name, address and initials must be included at the above rate. Cash should accompany all classified advertisements unless placed by an accredited advertising agency. No advertisement for less than ten words accepted. Ten percent discount on six issues, twenty percent for twelve issues. Objectionable or misleading advertisements not accepted. Advertisements for November, 1948, issue, must reach us not later than September 11, 1948.
Radio-Electronics, 25 W. Broadway, New York 7, N. Y.

26 YEARS EXPERIENCE RADIO REPAIRING AT your fingertips. I've perfected simple system you can follow step by step. No formulas or calculations. Cuts repair time to minimum. Total price \$2.00 postpaid or C.O.D. Money-back guarantee. Ross Radio 14615-T Grandriver, Detroit 27, Michigan.

RADIOMEN, SERVICEMEN, BEGINNERS — MAKE more money, easily, quickly, \$250 weekly possible. We show you how. Information free. Merit Products, 216-321, 132nd Avenue, Springfield Gardens 13, New York.

RADIO AS A HOBBY CAN PAY ITS WAY, AND yours too. Write: Grand Federal Argentine, Box 57C, Kansas City 3, Kansas.

THROAT MICROPHONE COMPLETE BRAND NEW T-30-S, 50c or 3 for \$1. Merchandise list free. SASCO, 10838 Ventura, North Hollywood, Calif.

TELEVISION: BUILD YOUR OWN. OUR DETAILED plans \$1.00. Teleprint, 834 1/2 E. 74th St., Los Angeles 1, Calif.

YOU CAN ACCURATELY ALIGN SUPERHETERODYNE receivers without signal generator. Complete instructions \$1. Money-back guarantee. Chas. Gates, Peecos 2, Texas.

AMATEUR RADIO LICENSES. COMPLETE THEORY preparation for passing amateur radio examinations. Home study and resident courses. American Radio Institute, 101 West 63rd St., New York City. See our ad on Page 91.

SELECTED GROUP OF MEN, GRADUATES OF WELL-known trade school, desire employment in Radio Field. Will travel anywhere. Qualified in radio servicing, installation, test instruments, circuit operation, etc. Contact Placement Dept., Eastern Technical School, 888 Purchase Street, New Bedford, Mass.

MAGAZINES (BACK DATED)—FOREIGN, DOMESTIC, arts, books, booklets, subscriptions, plus-ups, etc. Catalog 10c (refund). Cleeron's, 863 First Ave., New York 17, N. Y.

WE REPAIR ALL TYPES OF ELECTRICAL INSTRUMENTS, tube checkers and analyzers. Hazelton Instrument Co. (Electric Meter Laboratory), 140 Liberty Street, New York, N. Y. Telephone—B-Arley 7-4239.

LANCASTER, ALLVINE & ROMMEL, 436 ROWEN Building, Washington 5, D.C. Registered Patent Attorneys. Practice before United States Patent Office. Validity and infringement investigations and Opinions. Booklet and form "Evidence of Concealment" forwarded upon request.

BRITISH RADIO DEVELOPMENTS. EXPERTS IN Britain are producing many new ideas. Details of these advances, fully explained by leading technicians are included regularly in foremost British radio monthly, PRACTICAL WIRELESS. Features include constructional details, help and advice columns, and much of unique interest to both amateur and serviceman expert. Read everywhere by enthusiasts who wish to "keep ahead" in International trade or amateur DX field. Buy order now. For annual subscription mailed direct from London, send only \$2.00 to George Nevins, Ltd., (P.W.14), 312 Madison Avenue, New York 17.

BOTH BOOKS FREE

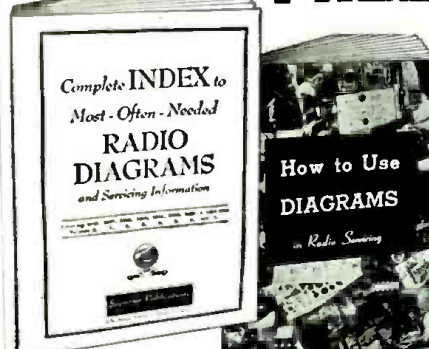

FREE to every reader of Radio-Electronics. No strings, nothing to buy. "How to Use Diagrams" gives hints, suggestions, short cuts on the use of diagrams in radio servicing. The 26-page INDEX will tell you just what models are included in "SUPREME" Most-Often-Needed Radio Diagrams. If you need a circuit at any time, the INDEX will tell you where to get it. Get both books in 2-in-1 volume FREE. Just send 2c stamp for postage.

SUPREME PUBLICATIONS 3727 W. 13th St. Chicago 23, ILL.

FREE!
It's nearly ready... the new, bigger, better-than-ever Walter Ashe Catalog of Radio and Electronics for 1949!
For "priority" delivery, reserve your free copy of this helpful, informative buying guide now. Simply write: "1949 Catalog" on a penny post card. Sign your name and address. Mail to:
WALTER ASHE RADIO CO.
1125 PINE ST. ST. LOUIS 1, MO.

ONLY \$89.50 IS THE COST!

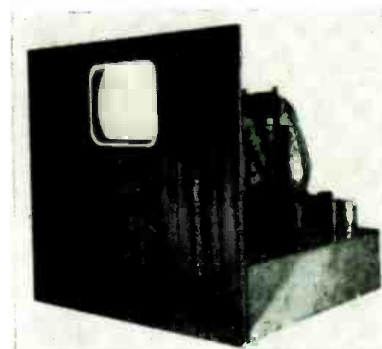

for the SENSATIONAL-NEW-IMPROVED

10 INCH TELEVISION KIT
less tubes

Complete with 13 channel tuner, all parts and easy step-by-step following instructions and schematics.

\$89.50 less tubes
Kit complete with all tubes \$149.50
Cost of cabinet \$25.00

Using the new 13 CHANNEL TUNER which is pre-wired and factory aligned for the entire television spectrum. The kit builder merely installs this unit into his chassis and makes three connections. Contains an R.F. stage, oscillator and mixer. It is extremely small and compact. Using new I.F. coils which provide maximum gain and picture definition. Sound reception is high quality F.M. for complete listening pleasure.

SAME TELEVISION KIT—7 INCH. complete less tubes \$59.50; complete with all tubes \$99.50

IMMEDIATE DELIVERY FROM STOCK

The New Model B-45 Battery Operated **SIGNAL GENERATOR**
for servicing AM, FM and Television Receivers. H. F. frequencies from 150 Kilocycles to 50 Megacycles (150 Kc. to 12.5 Mc. on Fundamentals and from 11 Mc. to 50 Mc. on Harmonics). Complete with shielded test lead, self-contained battery and instructions. NET \$27.75

The New Model TC-50 **TUBE AND SET TESTER**
A complete laboratory, all purpose test-instrument, this versatile combination tube and set tester will accurately test all up-to-date designed tubes. The multi-meter section affords many necessary measurements for everyday's service work.
The New Model TC-50 Tube and Set Tester combines seven instruments. D.C.V., A.C.V., D.C.M.A., Ohms, Output Meter, Decibel Meter and Tube Tester. Full scale accuracy to 2%. English Reading (400) and (BA) scale for testing tubes. Obscureness reduced to absolute minimum. Simple and quick reading charts for tube testing. Multimeter section affords most popular everyday's measurements.
Model TC-50 Tube and Set Tester operates on 90-120 Volts 60 cycles A.C. Housed in a sturdy beautiful portable, hand-rubbed cabinet. Complete with test leads, tube charts and all detailed operating instructions.
Size 8" x 10 1/2" x 5".....NET \$39.50
IMMEDIATE DELIVERY FROM STOCK

All orders filled same day received
Metropolitan ELECTRONIC & INSTRUMENT CO.
Dept. RC9 42 WARREN ST. N. Y. 7, N. Y.

REVOLUTIONARY SOLDERING IRON

TRANSVISION Soldetron

For Easier, Better Soldering—on Any Job!

- Weighs only 3 ozs., yet can do the job of a 200 watt iron.
- Heats up in twenty seconds from a cold start; saves time.
- Fingertip control; permits soldering without fatigue.



Ready for attachment and operation on 110 V. A.C., 50-60 cycles, through transformer supplied with iron, or 6-8 volt A.C. or D.C. without transformer (from an automobile battery). Overall size 9 1/2" x 15 1/8"; ship. wt. approx. 4 lbs.

- Ideal for fine precision work in "hard-to-reach" places.
- Readily interchangeable tip-heads; no cleaning or filing.
- Retains heat with switch off up to 1 minute; efficient.
- Bakelite handle, cork covering, for comfortable cool grip.

PRICE, including transformer and Tip-Head "A," \$13.95
5% higher west of Mississippi; fair traded.

Ask your distributor, or for further information write to:
TRANSVISION, INC., Dept. RC, NEW ROCHELLE, N. Y.
In Calif.: Transvision of Cal., 8572 Santa Monica Blvd., Hollywood 48

The HOUSE OF A MILLION RADIO PARTS

- No. 10 Y Tubes 49c
 - No. 1626 Tubes 49c
 - No. 1625 Tubes 49c
 - CRYSTAL PICKUPS
 - List \$6.50, our price \$1.95
 - McClintock Meters
 - 0-500 MA 3" square \$1.95
- Thousands of other bargains.
Write for our bulletin No. C-911

Lifetime Sound Equipment Co.

911-913 Jefferson Ave., TOLEDO 2, OHIO

Write for FREE specifications on these
GOV'T SURPLUS—JAN-INSPECTED TUBES
RCA 1630 UHF—ORBITAL beam amplifier
tremendous possibilities, high ampl. factor, 6.3 volts, 12GF7, 954, 304TH, 5LP7, 854, 304TH, 5CP1, 800, 393A, 5AP4, 559, 371B, 5AP1, 2X2A, 3B24, 4AF10, HY1110, 434A, ML502, 8013, WL468

All tubes made for U.S. during the war, all arc boxed. Attractively priced to quantity buyers. Some tubes as low as five cents each. Eimac & Ken-Rad 304TH tubes in stock.

GOULD GREEN
107 W. Broadway New York City 13

★ POLICALARM
F. M. RADIO RECEIVER
\$39.95

Excise tax included. F.O.B. Indianapolis. \$10 cash, rest C.O.D. Slightly higher west of Rockies.

TUNES 152-162 MEGACYCLES
6-tube superheterodyne, ready to operate. Veneer cabinet 9 1/2 x 6 1/4 x 5 1/4 deep, wt. 6 lbs. Schematic inside back cover, warranty outside. 2 stages high gain 10.7 megacycle I. F.'s. Guaranteed reception from local F.M. transmitters with attached antenna—police, cabs, others. Ready to plug in and use. 115 volts, A.C.-D.C. Power consumed 2B watts.

SOME CHOICE DEALERSHIPS OPEN . . . WRITE

RADIO APPARATUS CO.
729 N. BANCROFT ST. INDIANAPOLIS 1, IND.

● TUBE SPECIALS ●

AC-DC Ave—50L6GT, 35Z6GT, 12SA7, K7, 07GT, \$1.90
Miniature Ave—5015, 35A3, 12AT6, 12A6, BE6, \$1.90
★ **TWO JUMBO ASSORTMENTS** ★
40-3723, 20-50L6, 10 ea. 35L6, 12SA7, K7, Q7, 100 tubes.
40-35W4, 30-5015, 10 ea. 12AT6, 12A6, BE6, 100 tubes.
Either of the above specials at only \$34.00
Every tube new and perfect. Guaranteed 100%.

Selenium rectifiers 100MA—ten for \$7.20
Postage extra. 20% deposit on C.O.D. orders.
Send for our new bargain C.O.D. orders.

HALLMARK ELECTRONIC CORPORATION
592 Communipaw Ave. Jersey City 4, New Jersey

COUPON-OF-THE-MONTH

TUBES—STD. BRAND 35Z6GT or 35W4 10 for \$3.90
TUBES—STD. BRAND 12SQ7 or 12AT6 10 for 4.90
TUBES—STD. BRAND 50L6GT or 50B5 10 for 5.90
SAPPHIRE PHONO NEEDLES (List \$2.50) 10 for 2.90
STD. BRAND tube Superhet. (Nat. Known) 13.95
STD. BRAND—40-40 MPD 10 for 4.40
BY-PASS CONDENSERS—.005 or .01 MFD 10 for 5.40
600V

• Combination Kit—All Above Items—Only \$37.50
WITH THIS COUPON—ORDER AT ONCE

• RADIO: 3 tube Superhet. (Nat. Known) 6.95
• RADIO: 1 tube Superhet. (Nat. Known) 13.95

Write for Monthly Coupons and Bulletin

RADIO DISTRIBUTING CO. PASADENA 18, CAL.

"POCKET TALKIE"

Assemble World's Smallest
for as low as \$9.95

REALLY WORKS—talk and hear 2-10 miles or more—FITS IN YOUR POCKET! Uses flashlight batteries. ABOUT SIZE OF 2 PACKS CIGARETTES! Wt. 1 LB.

SEND ONLY \$1.00. Includes cash, check or M.O. or pay postman \$1.52 C.E.D. For photos, picture blueprints, instruction book, parts list, list with DETAILED CATALOGUE ON 135 OTHER PRODUCTS SUCH AS: (\$1.00 refunded on parts orders)

3-tube Pocket Radio
Cigar Box Vacation Transmitter
Electronic Burglar Alarms
Dash Car Transmitter
Radio Garage Door Openers
3-tube Heating Aid

MOTOR INDUSTRIES CO., Dept. RW-9 Kearney, Neb.

Get Started in Radio

10 "HOW-TO-DO-IT" BOOKS

Get a solid foundation in radio by means of these 10c timely text books. Each clearly written, profusely illustrated, contains over 15,000 words. You'll be amazed at the wealth of information packed into these handy books. Excellent for reference—ideal for technical library. Your money back if not satisfied.

5 BOOKS for 50c
10 BOOKS for \$1.00

Sent to You Postpaid (Leading Terms)

No. 1—How To Make Four Doerle Short Wave Sets
No. 2—How To Make The Most Popular All-Wave 1 and 2 Tube Receivers
No. 3—Alternating Current for Beginners
No. 4—All About Aerials
No. 5—Beginners' Radio Dictator

No. 6—How To Have Fun With Radio
No. 7—How To Read Radio Diagrams
No. 8—Radio for Beginners
No. 9—Simple Electrical Experiments
No. 10—Television or money register letter if you send cash or stamp.

RADIO PUBLICATIONS
25A West B'way, New York (7)

Freq.	Station	Location and Schedule
6.510	CP40	COCHAHAMBA, BOLIVIA; 1930 to 2200
6.620	TG2	GUATEMALA CITY, GUATEMALA; 1800 to 2300
6.700	YNDS	MANAGUA, NICARAGUA; 0800 to 1000; 1700 to 2330
6.770	CP49	LA PAZ, BOLIVIA; 0700 to 0900; 1100 to 1200; 1930 to 2100
6.770		SINGAPORE, MALAYA; 0330 to 1200
6.850	YNOW	MANAGUA, NICARAGUA; 0800 to 2100
6.910	YNQW	MANAGUA, NICARAGUA; 1300 to 2300
6.980		MOSCOW, U.S.S.R.; 1600 to 1745; 2315 to 2345
6.980	F08AA	PAPEETE, TAHITI; Tuesdays and Fridays, 2200 to 2100
7.010	XPSA	KWEIYANG, CHINA; 2330 to 0030; 0430 to 0900
7.100		BISSAU, PORTUGUESE GUIANA; 1315 to 1730
7.120	GRM	LONDON, ENGLAND; 1115 to 1215; 1445 to 1715; 2330 to 2315
7.130	VQ6MI	HARGEISA, BRITISH SOMALILAND; 0800 to 1030; 1200 to 1300
7.150	XGOY	CHUNGKING, CHINA; 0530 to 0730; 0715 to 0945; 1000 to 1045
7.160	KWS4	VIENNA, AUSTRIA; 2345 to 2030
7.220	JCKW	JERUSALEM, PALESTINE; 2330 to 1600
7.220		SINGAPORE, MALAYA; 2330 to 0130
7.250	PJCI	WILLEMSTAD, CURACAO; 1130 to 1300; 1630 to 2130
7.250	Munich II	MUNICH, GERMANY; 1100 to 1700
7.260	GSU	LONDON, ENGLAND; 2315 to 2330; 2315 to 0130; 1000 to 1500
7.280	JLW	TOKYO, JAPAN; 0300 to 0900; 1600 to 1800; 2200 to 0230
7.290	VUD3	DELHI, INDIA; 0800 to 1100; 1730 to 1825; 2100 to 2300
7.290	ZOY	ACCRA, GOLD COAST; 1045 to 1300
7.300		MOSCOW, U.S.S.R.; 1300 to 1800; 1815 to 2100
7.310	YSN	SAN SALVADOR, SALVADOR; 1300 to 1500; 1900 to 2300
7.380	HEK3	BERNE, SWITZERLAND; 1000 to 1015; 1515 to 1530
7.570	EAJ43	SANTA CRUZ, CANARY ISLANDS; 0730 to 0900; 1230 to 1700
7.570		TIRANA, ALBANIA; 1300 to 1630
7.570		CAIRO, EGYPT; 1400 to 1920
7.570		ALICANTE, SPAIN; 0700 to 1000; 1100 to 1800
7.850	ZAA	BEIRUT, LEBANON; 0900 to 0115; 0515 to 0800; 1030 to 1500
7.820	SUX	HAVANA, CUBA; 0700 to 2330
7.950		CAMAGUEY, CUBA; 2000 to 0030
8.030	FXE	HAVANA, CUBA; 0530 to 0030
8.030	COBZ	SANTIAGO, CUBA; 0600 to 2300
8.080	CNR3	HAVANA, CUBA; 0700 to 0100
8.080		RABAT, MOROCCO; 0145 to 0500; 1315 to 1900
9.180	CR6RB	BENGUELA, ANGOLA; 1330 to 1430
9.180	HEF4	BERNE, SWITZERLAND
9.210	H12G	CIUDAD TRUJILLO, DOMINICAN REPUBLIC; 0530 to 0830; 1300 to 1330; 1700 to 1845
9.230	COBQ	HAVANA, CUBA; 0800 to 1200; 1730 to 2330
9.270	COCX	HAVANA, CUBA; 0700 to 0030
9.330		SOFIA, BULGARIA; 2300 to 0100; 0530 to 0700; 1100 to 1330; 1400 to 1515
9.340	HBL	GENEVA, SWITZERLAND; 1300 to 1500
9.370	EAQ	MADRID, SPAIN; 1330 to 1600; 1830 to 2200
9.380	COBC	HAVANA, CUBA; 0700 to 2400
9.380	OTC	LEOPOLDBVILLE, BELGIAN CON. FED.; 0800 to 0200; 1100 to 1500
9.420		BELGRADE, YUGOSLAVIA; 0900 to 1230; 1630 to 0115; 1000 to 1045; 1100 to 1125
9.440	FZ1	BRAZZAVILLE, FRENCH EQUATORIAL AFRICA; 0000 to 0130; 1100 to 2020
9.460	TAP	ANKARA, TURKEY; 1000 to 1615; Sun, Mon, Thurs, 1530 to 1545
9.470	CR6RA	LOUANDA, ANGOLA; 0115 to 0230; 0530 to 0745; 1400 to 1530
9.480		MOSCOW, U.S.S.R.; 2200 to 0200
9.500	XEW7	MEXICO CITY, MEXICO; 0800 to 0200
9.500	OIX2	LAHTI, FINLAND; 0100 to 0130; 0510 to 0740; 1000 to 1600
9.510	JLG2	TOKYO, JAPAN; 0300 to 0830
9.520	VLW7	PERTH, AUSTRALIA; 0530 to 1030; 1600 to 1900
9.520	ZRG	JOHANNESBURG, SOUTH AFRICA; 0900 to 1545
9.520	OZF	COPENHAGEN, DENMARK; 1145 to 1545
9.520	SEAC	COLDMO, CEYLON; 1930 to 1200
9.530	WGEO	SCHENECTADY, NEW YORK; 1900 to 2330
9.530	SBU	STOCKHOLM, SWEDEN; 2000 to 2100
9.540	VLR	MELBOURNE, AUSTRALIA; 0800 to 0915; 0930 to 1000; 1245 to 1115
9.540	LKJ	OSLO, NORWAY; 0300 to 0315; 0500 to 0715; 1000 to 1700
9.540	Munich II	MUNICH, GERMANY; 1100 to 1700
9.540	CJCA	EDMONTON, CANADA; 0815 to 0200
9.550		PRAGUE, CZECHOSLOVAKIA; 1215 to 1230; 1315 to 1330; 1400 to 1430; 1445 to 1500; 1515 to 1530; 1600 to 1630; 1645 to 1700
9.550	XETT	MEXICO CITY, MEXICO; 0700 to 0100
9.550		PARIS, FRANCE; 0000 to 0130; 0715 to 0845
9.560		KOMSOLOLSK, U.S.S.R.; 2100 to 2400
9.570	KWID	SAN FRANCISCO, CALIFORNIA; 0700 to 1000
9.570	WRUW	BOSTON, MASSACHUSETTS; 2000 to 2200
9.570	KWIX	SAN FRANCISCO, CALIFORNIA; 2215 to 0315
9.580	GSC	LONDON, ENGLAND; 1330 to 1345; 1430 to 1530; 1600 to 1615; 1815 to 2045
9.580	VLH3	MELBOURNE, AUSTRALIA; 0345 to 0830; Sat., 0245 to 0900; Sun., 0330 to 0830
9.580	VUD5	DELHI, INDIA; 0900 to 1230
9.590	WLW0	CINCINNATI, OHIO; 1530 to 1700

ESPERANTO A WORLD NEED

Dear Editor:

I have just read Glenn R. Turner's letter in the June issue of RADIO-CRAFT and I think he has the right idea on Esperanto.

Americans don't feel the need for an international language because English is spoken all over America. Hence the poor response when Hugo Gernsback proposed Esperanto over station WRNY. But here in Europe the situation is very different. You tune your radio and hear half a dozen different languages from stations only a few miles away. People get annoyed about it.

When Radio Budapest first started broadcasting in Esperanto about 12,000 letters came in, all enthusiastic. Now over a dozen European stations have Esperanto programs, in addition to at least one Brazilian station.

When the distance between continents has been reduced to almost nothing by technology, as that between European countries has been, Esperanto will become a must. The introduction and encouragement of Esperanto might well become radio's most effective contribution to the cause of peace.

ANTHONY A. MÜNNICH,
Budapest, Hungary

NO GIMMICKS, PLEASE

Dear Editor:

I have seen several articles telling how servicemen have been "tested" with "gimmicked" sets. I offer a solution which will determine the honesty of a repairman. It will stop the complaints about impossible faults that a trained man would not normally see.

Use sets which are perfect in every respect except that there is one blown-out tube. This is a common trouble and the repairman could not complain.

If the customer is told that he had a "pyroliated helical with impaired cross-modulation which ruined all the tubes" and is handed a bill for \$19.75, he will have a good excuse to get out his shootin' irons. If the bill is for one tube plus a small service charge, he will have no complaint.

DOYLE STRANLUND,
Homestead, Mont.

(Replacing a bad tube would not involve any real repair work. How about inserting a faulty power-supply filter capacitor instead?—Editor)

OLD E. I. CO. CUSTOMER

Dear Editor:

Reading the article on "The Crystal Detector" in the June issue and seeing the old 1908 Electro Importing Company ad for the Electro Universal Detector Stand, I remembered that I had bought one of these stands through one of Hugo Gernsback's magazines when I was a boy of 12.

I have kept up with the Gernsback magazines all through the years, and still read them regularly.

C. E. JONES,
Springfield, Mo.

OCTOBER, 1948

FOR FINER FM-AM RECEPTION THIS TUNER-AMPLIFIER COMBINATION

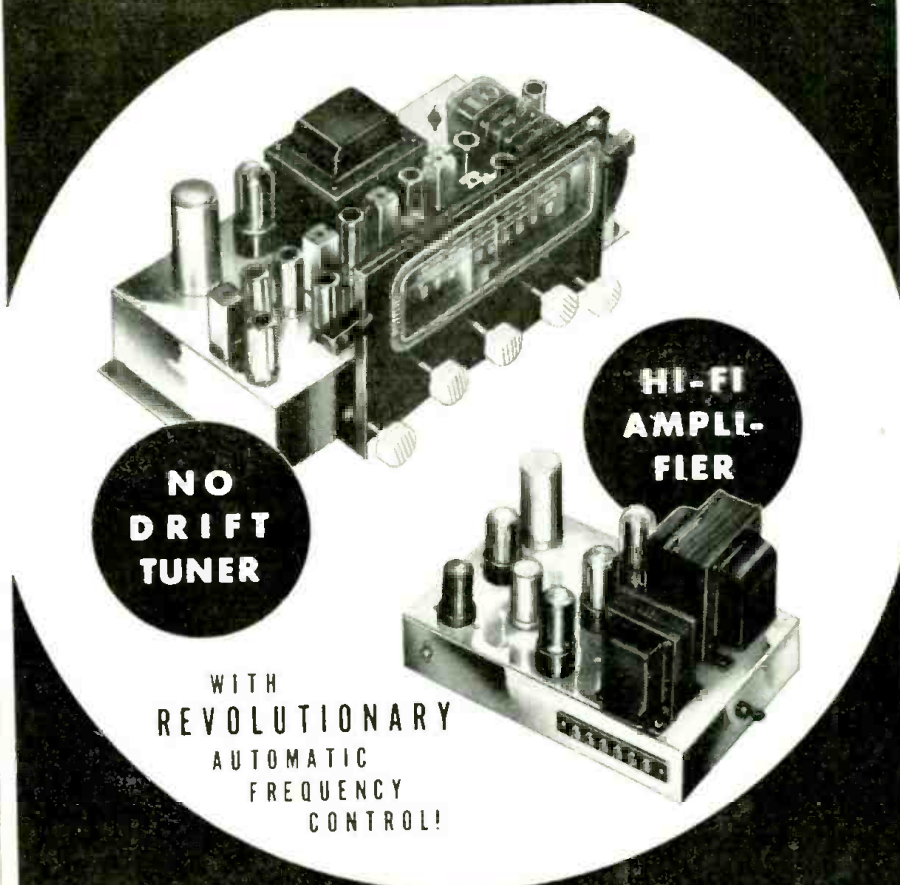

WITH
REVOLUTIONARY
AUTOMATIC
FREQUENCY
CONTROL!

FM-AM TUNER RC-8 Features automatic-frequency control, most revolutionary development in FM design—entirely eliminates drift and multiple tuning responses. Nine shielded miniature tubes plus rectifier include double limiter and tuned RF stage in both FM and AM. Low-impedance loop, enabling flexibility in mounting, provides low-noise AM reception. Rear socket provides easy access to 6.3-volt AC and exceptionally well-filtered 100-volt DC for supplying external pre-amplifiers, additional pilot lights, etc. Controls include separate bass, treble and switch positions for phonograph and television

audio inputs. Polished chrome chassis. Audio cable, escutcheon, decals, antennae, and detailed installation instructions furnished.

HI-FIDELITY AMPLIFIER RC-2 High impedance input; 12 watts output at 1% distortion. Taps: 4, 6, 8, 15, 500 ohms. 65 db gain including inverse feedback. Uniform frequency response from 20 to 20,000 cycles up to 8 watts output. Hum 65 db below rated output. Tubes: 6J5, 6SN7, (2) 6V6, 5Y3. Durable polished chrome chassis.

Write for Descriptive Circular "D" and Prices.

The RADIO CRAFTSMEN, Inc.
1341 S. MICHIGAN AVENUE, CHICAGO 5, ILL.

SHANEY'S
New
20 STEPS TO PERFECT AMPLIFICATION
SEND 3c STAMP FOR POSTAGE
AMPLIFIER CORP. of AMERICA
398-10 Broadway New York 13, N. Y.

SPEAKER RECONING
ALL WORK GUARANTEED

3"—\$1.40	7"—\$1.95	15"—\$4.00
4"—1.40	8"—2.20	4x6—1.90
5"—1.50	10"—2.70	5x7—2.20
6"—1.65	12"—3.00	6x9—2.50

OXFORD RECONING SERVICE
1039 Selby Ave. St. Paul, Minn.

500 FORMULAS TO SUCCESS

MANY million dollar firms started with a single formula, for which they paid a big price. Here you have 500—no less—tried and tested formulas, recipes and processes for making things—all at the ridiculously low price of 25c. Here is your opportunity to start a business with but a few dollars' capital and with undreamed of profits in prospect. You can also use these formulas in your own home to cut household expenses to the bone. Or you can put them to use in your workshop to cut costs as much as 1000%.

Quit paying out many dollars in profits to manufacturers, wholesalers, and dealers, when you can make the same thing yourself for a few cents. It's so easy when you follow our simple instructions.

66 PAGES. 3200 WORDS IN TEXT

Send for "500 FORMULAS AND RECIPES" today. Enclose 25c, that's all! You won't be asked for another cent now or later. Sold on a money-back guarantee.

NATIONAL PLANS COMPANY
P. O. BOX 26 R. STATION N. New York 23, N. Y.

RADIO SCHOOL DIRECTORY

Become a Radio and

TELEVISION TECHNICIAN

IN 18 MONTHS!

Here is the opportunity you have been waiting for. Now you can get in on the ground floor of the nation's fastest growing industry—TELEVISION.

LOOK AT THIS RECORD — In 1946 only 6,500 television sets were manufactured — in 1947 this skyrocketed to 175,000 — already in the first four months of 1948 over 160,000 sets have been produced. This means hundreds of new jobs are being created every month.

MSOE NOW ADDS TELEVISION — The Milwaukee School of Engineering now provides complete, practical, technical training in television as well as Radio in its laboratories. This is not just a *serviceman's* course. The special 18 month's residence course includes complete training in radio as well as television — qualifies you for a successful career as a technician in all phases, AM, FM, TV Receivers and Transmitters and Radio Communications.

This Technician Course Prepares You For Any Of These Jobs:

- | | |
|-----------------------------------|----------------------------------|
| Radio Servicing — AM and FM | Taxicab transmitters operating |
| TV receiver servicing | and receiver servicing |
| Broadcast Station Operating | Railroad transmitters operating |
| Electronic Parts Sales | and receiver servicing |
| Radio and TV sales | Supervising and testing in radio |
| Radio and TV manufacturing | and TV manufacturing |
| Police transmitters operating and | Shop managing |
| receiver servicing | |



Electrical Engineering
Bachelor of Science Degree
in 2 additional years
Majoring in **ELECTRONICS**

MILWAUKEE SCHOOL OF ENGINEERING
"A Technical Institute • Founded 1903"
Dept. RC 1048 N. Broadway, Milwaukee, Wis.

COURSES

SERVICE

- 6 to 12 Months
- Practical Electricity
- Welding
- Refrigeration
- Heating

TECHNICIAN

- 12 to 24 Months
- Electrotechnics
- Radio and Television
- Electronics
- Refrigeration, Heating and Air Conditioning

PROFESSIONAL

- 36 Months
- Electrical Engineering
- Bachelor of Science Degree
- Major in Machinery or Electronics

Terms start January, April, July.

MILWAUKEE SCHOOL OF ENGINEERING,
N. Broadway and E. State, Milwaukee, Wis.
Without obligation send me free booklet "Career Building" and more details on course in Radio and Television or.....course.
Name.....Age.....
Address.....
City.....State..... (nc1048)

WANTED: Men and Women to Fill TOP RADIO JOBS in AM-FM-Television

If you are looking for a career with a future, why not join the hundreds of graduates from the Don Martin School of Radio Arts now successfully employed in the radio industry. The demand is great for qualified radio personnel in AM-FM-Television. Train now to be an announcer, script writer, disk jockey, newscaster, or radio technician. Complete day and night classes with the latest equipment. Free placement service. Approved for veterans. Write for free booklet.

Don Martin School of Radio Arts

1655 North Cherokee St. Hollywood 28, Calif.

RADIO COURSES

- RADIO OPERATING
- RADIO SERVICING
- CODE
- F.M. TELEVISION
- ELECTRONICS

• REFRIGERATION SERVICING

Write for Catalog and Picture Brochure

Y.M.C.A. TRADE & TECHNICAL SCHOOLS
15 W. 63rd St. (N'r B'way) New York City



RADIO COURSES

Preparatory, Service, Broadcast, Television, Marine Operating, Aeronautical, Frequency Modulation, Radar.

Classes forming for fall term Oct. 1.
Entrance exam Sept. 20.
Veterans. Literature.

COMMERCIAL RADIO INSTITUTE
(Founded 1920)
38 West Biddle Street, Baltimore 1, Md.

RADIO

TECHNICIAN and RADIO SERVICE COURSES
FM and TELEVISION

AMERICAN RADIO INSTITUTE

101 West 63rd St., New York 23, New York
Approved Under GI Bill of Rights
Licensed by New York State

Hollywood Experts Help You **Make Good in RADIO-TELEVISION** at Home

Direct from Hollywood, nerve-center of broadcasting, Television, Radio and Sound activities, comes R-T-A's time-proven and tested home training. Here at last—easy to learn, home instruction that quickly qualifies you for steady, good-pay jobs or your own Radio business. 10 big kits of radio parts given at no extra charge. Get full details at once! Send postal for **FREE BOOK** "How to Make Good in Radio-Television."

RADIO TRAINING ASS'N OF AMERICA, Dept. RCJ
5620 Hollywood Blvd. Hollywood 28, Calif.

CORRESPONDENCE COURSES IN RADIO and ELECTRICAL ENGINEERING

ELECTRICAL ENGINEERING Get good grasp of wide electrical field. Prepare yourself at Low Cost, for secure future. Modern course. So simplified anyone can understand quickly.

RADIO ENGINEERING Extra fine course in radio work. Trains you to be super-service man, real vacuum-tube technician. Servicemen needed badly. Diploma on completion. Many graduates earning big pay.

Send postcard for Free Copies of school catalog, full details, and \$25 Either about deferred payment plan, experimental kits, etc.

WRITE Lincoln Engineering School, Box 931-C-116, Lincoln 2, Nebr.

RCA **RADIO and TELEVISION**

Thorough Training in All Technical Phases
APPROVED FOR VETERANS

DAYS-EVENINGS WEEKLY RATES

RCA GRADUATES ARE IN DEMAND

For Free Catalog Write Dept. RC-48

RCA INSTITUTES, Inc.
A Service of Radio Corporation of America
350 WEST 4TH STREET NEW YORK 14, N. Y.

TELEVISION 1948!!

Train at an Institute that pioneered in TELEVISION TRAINING since 1938. Morning, Afternoon or Evening Sessions in laboratory and theoretical instruction, under guidance of experts, covering all phases of Radio, Frequency Modulation, Television, lead to opportunities in Industry, Broadcasting or own Business. Licensed by N. Y. State. *Approved for Veterans.*

ENROLL NOW FOR NEW CLASSES
Visit, Write or Phone

RADIO-TELEVISION INSTITUTE
480 Lexington Ave., N. Y. 17 (46th St.)
Plaza 3-4585 2 blocks from Grand Central

CODE SENDING SPEED
RECEIVING SPEED

Be a "key" man. Learn how to send and receive messages in code by telegraph and radio. Commerce needs thousands of men for jobs. Good pay, adventure, interesting work. Learn at home quickly through famous Candler System. Qualify for Amateur or Commercial License. Write for **FREE BOOK**.

CANDLER SYSTEM CO.
Dept. 3-1, Box 928, Denver 1, Colo., U.S.A.

SOUND RECORDING SCHOOL

A practical engineering course in Sound Fundamentals, Recording, and Sound Transmission measurements; in a laboratory containing transmission sets, oscillators, square wave generator and heterodyne analyzer, and other equipment.

Complete recording studio assimilating broadcast, motion picture and commercial sound recording, under the direction of H. M. Friedman.

HOLLYWOOD SOUND INSTITUTE, Inc.
1040-C No. Kenmore Hollywood 27, Calif.

LEARN RADIO!

IN ONLY 10 MONTHS
PREPARE FOR A GOOD JOB!
COMMERCIAL OPERATOR (CODE)
BROADCAST ENGINEER
RADIO SERVICEMAN

Television Servicing—15 Months

Veterans get \$130.00 Equipment
SEND FOR FREE LITERATURE
BALTIMORE TECHNICAL INSTITUTE
1425 Eutaw Place, Dept. C, Baltimore 17, Md.

RADIO-ELECTRONICS for

AUDIO AMPLIFIERS, FM TUNERS AND INTERCOMS. Compiled and published by Howard W. Sams & Co. Regular Photofact size, 358 pages. Price \$3.95.

This specialized volume of Photofact folders includes data on all amplifiers, FM tuners, and intercom systems which have been covered by Photofacts since the end of the war. The volume is bound in paper covers and includes 102 post-war models produced by 29 makers.

Increasing importance of audio amplifiers was given as the reason for the edition. Sold before the war primarily for PA installations, amplifiers are now being used widely as the heart of custom-assembled home entertainment systems, in conjunction with FM tuners, and in modernization jobs.

The volume also includes complete material on the Webster Models 79 and 80 wire recorders.

THE ARCHITECTS MANUAL OF ENGINEERED SOUND SYSTEMS. Issued by Architectural Relations, Sound Equipment Section, RCA. Simulated leather covers, 288 pages, 9 1/2 x 11 1/2 inches. Price \$5.00.

As the title indicates, this volume is intended to be a general reference work for architects who deal with sound installations. As such, it is essentially an acoustical, rather than an electronic treatise, filling a gap which has existed for a long time.

Acoustics is not, at present, an exact science to the same extent as electronics, so the book necessarily appears sketchy. But there is at least some information on almost every conceivable type of sound installation. In addition to the acoustic aspects, the text goes into electrical requirements—wiring, types of amplifier units, loudspeakers.

Slightly over half the pages are devoted to floor plans and diagrams of typical setups. With each group of plans a set of sample specifications is presented.—*R.H.D.*

APPLIED PHYSICS: Electronics, Optics, Metallurgy. Edited by C. G. Suits, George R. Harrison, and Louis Jordan. Published by Little, Brown and Co. 6 x 8 1/2 inches, 456 pages. Price \$6.00.

This book, one of a series called "Science in World War II" devotes 194 pages to electronics. A history of the work of the National Defense Research Committee, it describes the work done by Division 13 (Electrical Communications), Division 15 (Radio Co-ordination), and the Committee on Propagation. Much of the material, especially that dealing with radar countermeasures, has appeared in various publications, and is here brought together in a form easy to refer to.

The section on Optics has some information on infra-red and ultra-violet light, and sound, which is interesting from the communications point of view.

RADIO ENGINEERING I

Complete Radio Engineering Course. Bachelor of Science Degree. Courses also in Civil, Electrical, Mechanical, Chemical, Aeronautical Engineering; Business Administration, Accounting, Secretarial Science. Graduates successful. 65th year. Enter Sept., Jan., March, June. Write for catalog.

TRI-STATE COLLEGE 24108 College Ave. ANGOLA, INDIANA

OCTOBER, 1948

BUILD from KITS

YOU CAN MAKE MODERN RADIOS AND TEST SETS YOURSELF!
IDEAL FOR SCHOOLS AND HOBBYISTS

VACUUM TUBE VOLTMETER KIT 012

- 6SN7 bridge type voltmeter circuit.
- 0-500 microamps DC, 4 1/2" square meter.
- Output meter—600 ohm circuit, 1 milliwatt reference level.

For high frequency FM and TV, 11 megohms DC, 6.5 megohms AC input resistance, .1 ohm to 1000 megohms in 5 ranges. Linear AC, DC volts 0-1000 volts, 5 scales, 6116 balanced linear diode AC rectifier, 1% precision resistor, 6x4x5". Probe for high frequency FM and TV available at extra cost. With complete instructions.



LIST PRICE .. \$29.95



2-BAND RECEIVER KIT S-6X

- ★ 6-tube
- ★ Equipped for 110 volts AC or DC

This 2-band receiver covers the following ranges: 550 kc-1600 kc., 6-16 mc. Complete with tubes and beautiful, sturdy bakelite cabinet ready for assembly.

LIST PRICE .. \$17.95

These and many other models available at the following jobbers:
CONCORD RADIO CORPORATION, Chicago, Ill.
RADIO WIRE TELEVISION, INC., New York City
OLSON RADIO WAREHOUSE, INC., Akron, Ohio
R & M RADIO COMPANY, Arlington, Va.
MISSION RADIO, San Antonio, Texas
OFFENBACH AND REIMUS, San Francisco, Cal.
If not available at your local jobber, write directly to us.

Write for Catalog K

RADIO KITS COMPANY
120 Cedar Street, New York 6, N. Y.

• TEST-AID • FIRST-AID FOR RADIO-TELE SETS

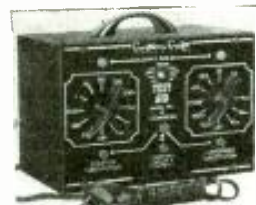

ONLY \$15.95

COMPLETE
WRITE FOR CATALOG SHEET

- QUICKLY LOCATES FAULTY CONDENSERS AND RESISTORS FOR FAST SERVICING
- SUBSTITUTES 11 DIFFERENT VALUES OF CAP. OR RES. WITH SET IN OPERATION 50mmf to 40mf 450-600 WVDC—27 ohms to 5 meg.
- CHECKS CONDENSER LEAKAGE ON DIRECT CURRENT SUPPLIED FROM OWN PWR SUP.
- OUTPUT INDICATOR FOR ALIGNMENT—CONTINUITY CHECKS
- PROVIDES 100 VOLTS AT 100 MA FOR EXPERIMENTS.

These are only a few of the many uses of the TEST-AID. See them at your dealer or write us direct.

Custom Craft
MANUFACTURING CO.

256 E. 98th STREET, BKLYN, N. Y.

12B8 and 25B8 Tubes!!

Composed of adapter, 1-6AT6 tube, 1-6BA6 tube, and 2 mini-tube sockets. The unit takes less space than the original 12B8 or 25B8 tube, and the adapter base will fit into the 12B8 or 25B8 socket. Nothing else to buy—unit is complete. Just plug in and it works. Sold on money back guarantee. 12B8 or 25B8 unit complete: \$2.19 each. 10 units for \$22.50.

TUBE SPECIAL:

7017 — \$.79 — 321.7—\$1.09
1 25B8 unit & 7017GT— 3.19
2 12B8 unit & 321.7GT— 3.49

COMMERCIAL RADIO
36 BRATTLE STREET, BOSTON 8, MASSACHUSETTS

Modern Design WALL BAFFLE



Large size and sturdy construction, with built-in heavy masonite and wood. For all weights of speakers. Size 12" Top, 12" Wide, 8" Bottom and 20" High. Master Baffle and speaker mounting screws supplied.

Model 1215W Natural Masonite Finish List .. \$16.00
Model 1215WS Ivory or Brown Wrinkle List .. \$18.50

Streamlined UNIVERSAL CABINET



Ideal for sound installations where an attractive baffle and good tone quality is sought. Dimensional Characteristics—Plus Natural Reproduction—Sturdy construction, in corner type design, combining heavy masonite and wood.

Model 6K 12"x12"x8" Natural Masonite .. \$ 8.00 List
Model 6KS 12"x12"x8" Ivory or Brown .. 10.00 "
Model 8K 14"x15"x9" Natural Masonite .. 10.00 "
Model 8KS 14"x15"x9" Ivory or Brown .. 13.50 "
Model 10K 17"x17"x10" Natural Masonite .. 14.00 "
Model 10KS 17"x17"x10" Ivory or Brown .. 18.50 "
Model 12K 18"x20"x10" Natural Masonite .. 16.00 "
Model 12KS 18"x20"x10" Ivory or Brown .. 18.50 "
Reducers for any of above baffles, each .. 30 Net
Above models patented and patents pending

Pressure Controlled LOUDSPEAKER ENCLOSURES

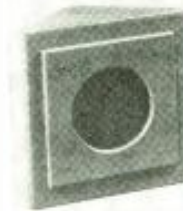

This acoustic pressure controlled cabinet achieves the ultimate in wide range, high level sound reproduction. Anti-Feedback characteristics contribute to unusual dimensional qualities, external and basic Tri-angular design and small space requirements offer numerous practical installation methods. Finished in attractive leatherette and constructed of heavy plywood.

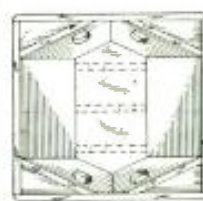

MASTER BAFFLES REMOVED

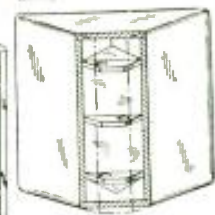

LOWER CELL COVER REMOVED

Model 6V 10"x10"x5" Ivory or Brown .. \$10.00 List
Model 8V 15"x15"x8" Ivory or Brown .. 17.50 "
Model 10V 17"x17"x8 1/2" Ivory or Brown .. 20.00 "
Model 12V 20"x20"x10" Ivory or Brown .. 22.50 "
Above models Patented and Patents pending in U.S., Canada and G.B.

New Super Sector LOUDSPEAKER CABINET

Designed for low cost general purpose use. Easily fitted to wall, ceiling, corners or multiple room installations. Five 12" speakers. Very sturdy construction of heavy plywood and finished in Ivory or Brown Leatherette. Excellent acoustic qualities and attractive finish for the finest installations.



Size 20"x20"x6" (specify color) List .. \$15.00
Reducers for 8" or 10" speakers Net .. 30
Acoustic Design Patent Applied For.

Usual discounts prevail to Jobbers, Dealers and Manufacturers. All prices F.O.B. San Francisco, California. No C.O.D.s.

VIBRALOC
Acoustic Products
MANUFACTURING CO.
3597 MISSION ST., SAN FRANCISCO, CALIF., U.S.A.

3597 MISSION STREET
San Francisco, California

RADIO TUBES

For immediate shipment

R.M.A. Guaranteed

Individually Sealed Cartons

GT Types		Miniature Types	
6K6GT	.40	1S5	.50
6K5GT	.46	1T4	.55
6V6GT	.46	1R5	.55
6SA7GT	.46	3S4	.55
6SJ7GT	.46	6BA6	.50
6SK7GT	.46	6BE6	.50
6SQ7GT	.46	6AT6	.42
6X5GT	.40	12BA6	.50
12SA7GT	.46	12BE6	.50
12SQ7GT	.46	12AT6	.42
12SK7GT	.46	35W4	.42
12SJ7GT	.46	50B5	.55
35L6GT	.40		
35Z5GT	.32		
50L6GT	.46		

25% DEPOSIT REQUIRED ON C.O.D.—2% C.O.D.
10% DISCOUNT ON LOTS OF 50 OR MORE

RAVAC ELECTRONICS CORP.

432 Fourth Avenue
New York 16, N. Y.

SENSATIONAL BUYS!



**FAMOUS R.C.P.
HI-MEG
MULTITESTERS**
Model 450A ONLY
\$20.95

Are you impressed by big names and sky-high prices? R.C.P. is big, too—but big enough to yank down instrument prices even for shoe-string bankrolls. This model #450 series compares with the finest precision testers on the market—yet costs you approximately half! Slashed operating costs help you compete for more service business. Order now from your jobber, or write direct.

• Top resistance range of 50 Megohms, no tubes or batteries required. *24 ranges of volts-ohms-current-c/b. *Wide scale meter, 4 1/2". 1,000 ohms p.v. *Fine germanium crystal rectifier for AC. *Handsome panel, heavy duty oak case.

- MODEL 450AP, Portable @ \$24.95
- MODEL 450C, 20,000 ohms p.v. @ \$28.50
- MODEL 450CP, De Luxe Portable @ \$32.50

SEE R.C.P.—BEST FOR EVERY TEST

RADIO CITY PRODUCTS CO., INC.

152 West 25th Street

WE'VE MOVED

More Space—Better Service

3 TUBE PHONO AMPLIFIER

\$1.95



COMPLETELY WIRED, VOLUME AND TONE CONTROLS

Set of 3 tubes: 50L6, 35Z5, 12A6 \$1.10
Output trans. 50L635
1/2 Meg. vol. control with sw.35
1" pm speaker95
3" pm speaker 1.15
6" pm speaker 1.55
6x4" pm speaker 1.39
8" pm speaker 2.49
Webster pickups 1.79
Astatic Cartridges L-70A, L-26A 1.49
Alliance motor & Turntable 2.50
VM #400 INTERMIX CHANGER 24.95
G.E. Reluctance Cartridge 4.54
Phono Pre-Amplifier complete with tubes 4.95
Phono Oscillator complete with tubes.. 4.32
Oscillator Coil, 12SA715

All prices F.O.B. N.Y.C.—on C.O.D. 25% Deposit.
Write for free catalog.

THE ROSE COMPANY

98 Park Place, Dept. C, New York 7, N. Y.

TALK ANYWHERE INSTANTLY TO ANYONE
WITH INTER-TALKIE! JUST PUSH BUTTONS AND TALK TO OR FROM 7 DIFFERENT PLACES! NOT A PHONE—LOUD ROOM VOLUME—NO ELECTRIC "PLUG INS" OR TUBES NEEDED! SIT OR HANG IT! SIMPLE TO HOOK UP. FOR HOMES, OFFICES, STORES, FARMS, ETC. GUARANTEED! WRITE FOR FREE DETAILS TODAY!
MIDWAY SALES CO., Dept. RC-10, KEARNEY, NEBR.

SMOOTH FM TV VHF SERVICING

This VHF ALIGNMENT WAND gives a constant check on the alignment of FM, TV & other 5-500 mc equipment during servicing. Its blending of repair and alignment makes servicing smooth and fast. Solves your TRACKING, SENSITIVITY & S/N problems. Tells which adjustment to make, which way and how much. A modern shop MUST!
HAWKINS RADIO COMPANY
621 East 31st Street Kansas City 3, Mo.

Prepare For A Good Job Now in

RADIO SOUND and TELEVISION

LEARN QUICKLY IN THE GREAT SHOPS OF

COYNE

NOT A "HOME STUDY" COURSE
Get ready for a better job, bigger pay NOW in Radio. Cash in with "All-around" knowledge of Radio—Sound—Television. Train on actual equipment not by "Home-study". You learn quickest at COYNE because it's a real SHOP course!
G. I. APPROVED . . . also Finance Plan for NON-VETERANS. Don't let lack of cash hold you back. Many earn while learning. FREE Employment Service to graduates. Get facts today!

SEND COUPON FOR FREE BOOK
Send at once for Big Free Book on Radio, Sound and Television, and facts about our Finance Plan.

MAIL THIS COUPON TODAY

B.W. COOKE, Pres., Coyne Electrical and Radio School
500 S. Paulina St., Dept. 78-24, Chicago 12, Ill.
Please send Big FREE Book and complete details.

NAME.....
STREET.....
CITY..... STATE.....

Index to Advertisers

Allied Radio Corporation	8
Almo Electronics, Inc.	75
Alvaradio Supply Co.	82, 85
American Surplus Products Co.	66, 67
Amperite Co., Inc.	80, 81, 93
Amplifier Corporation of America	80, 81, 93
Walter Ashe Radio Co.	91
Audel Publishers	11
Bell Telephone Labs.	Inside Back Cover
Boland & Boyce Publishers, Inc.	63
Bradshaw Instruments Company	51
Brooks Radio Distributing Co.	16
Buffalo Radio Supply	72, 73
Burstein-Applebee Company	84
Capitol Radio Engineering Institute	6, 45
Certified Television Laboratories	84
Cleveland Institute of Radio	17
Collins Audio Products Co., Inc.	88
Commercial Radio	95
Communications Equipment Co.	18
Coradio Co.	80
Coyne Electrical School	96, 97
Custom Craft Mfg. Co.	95
DeForest's Training Institute	13
The Electric Auto-Lite Company	10
Electronic Corp. of America	87
Electronic Research, Inc.	80
Electro-Voice Manufacturing Co.	89
Espey Mfg. Co., Inc.	82
Fair Radio Sales	74
Feiler Engineering Company	85
Franklin-Ellis	79
General Cement Mfg. Co.	83
General Electronic Distributing Co.	47, 83
General Test Equipment	80
Gould Green	92
Graylock Electronic Supply Co.	81
Hallcrafters Co.	81
Hallmark	92
Hawkins Radio Company	96
Heath Company	58, 59
Instructograph Company	85
International Correspondence Schools	9
JFD Manufacturing Company	77
The JRI Trainers	82
Kierulff & Company	80
S. Kleinman	90
Lafayette-Concord	49
Leotone Radio Corporation	87
Lifetime Sound Equipment Co.	92
McGraw-Hill Book Co.	97
McMurdo Silver, Inc.	71
P. R. Mallory & Co., Inc.	Back Cover
Metropolitan Electronic & Instrument Co.	91
Mid-America, Inc.	54
Midway Sales Co.	96
Midwest Radio Corporation	12
Moss Electronic Distributing Co.	53
Motor Industries Company	92
Murray Hill Books, Inc.	78, 85
National Plans Co.	93
National Radio Institute	3
National Schools	5
Nelson-Hall Co., Publishers	70
Opportunity Adlets	91
Oxford Reconing Service	93
Precision Apparatus Company	77
Progressive Electronics Company	76
Radio Apparatus Co.	92
Radio City Products Co., Inc.	96
Radio Corporation of America	14, 15
The Radio Craftsmen, Inc.	93
Radio Dealers Supply Co.	86
Radio Distributing Co.	92
Radio Kits Co.	95
Radionic Equipment Company	90
Radio Publications	92
Radio Supply & Engineering Co.	86
Ravac Electronics Corp.	96
Risco Electronics	75
The Rose Company	96

RADIO SCHOOL DIRECTORY (Pages 94-95)

American Radio Institute	
Baltimore Technical Institute	
Candler System Company	
Commercial Radio Institute	
Don Martin School of Radio Arts	
Hollywood Sound Institute, Inc.	
Lincoln Engineering School	
Milwaukee School of Engineering	
RCA Institutes	
Radio Television Institute	
Radio Training Association of America	
Tri-State College	
YMCA Trade & Technical Schools	
Howard W. Sams & Co., Inc.	19
The Sargent-Raymont Co.	80
Senco Radio, Inc.	64, 65
N. Silverstine	57
Solar Manufacturing Corp.	4
Sprague Products Company	20
Sprayberry Academy of Radio	7
Superior Instruments, Inc.	88
Supreme Publications	91
Tarrytown Metalcraft Corp.	77
Technical Radio Parts Co.	84
Terminal Radio	Inside Front Cover
Transvision	61, 92
Vibratoc	95
Wells Sales, Inc.	98
York Distributing Co.	80

ELECTRONIC ENGINEERING PRINCIPLES, by John D. Ryder. Published by Prentice-Hall, Inc. 6 1/4 x 9 1/4 inches, 398 pages. Price \$6.65.

Written by a professor of electrical engineering who has specialized in electronic tubes, this book will prove valuable to anyone interested in studying the action of the various types of tubes. Tubes covered include the cathode-ray indicators, diode rectifiers, vacuum triodes, multi-element tubes, amplifiers for small and large signals, gas diodes, gas-control tubes, photoelectric cells, the cyclotron, and the mass spectrograph.

The author begins with the explanation of the fundamental particles (the various types of atoms), electron ballistics as applied to vacuum tubes, and the actions taking place in such tubes as the cathode-ray type. The necessary mathematics is included, together with curves and diagrams so that the reader is enabled to follow the material easily.

The section on thermal and field emission of electrons is very refreshing and makes the subject much clearer than many textbooks on the subject. References are given so the reader can delve more deeply into the various subjects discussed if he desires further information.—*H.W.S.*

ULTRA- AND EXTREME-SHORTWAVE RECEPTION, by M. J. O. Strutt. Published by D. Van Nostrand Co., Inc. 400 pages, 5 3/4 x 8 1/2 inches. Price \$7.50.

This book covers the design of receivers and antennas for use in the h.f., v.h.f., u.h.f., and s.h.f. (micro-wave) regions. It embraces the frequencies, from 6 to 30,000 megacycles (fifty meters to one centimeter in wavelength). Basic data is given for designing radio receiving equipment throughout this entire range.

The opening chapters deal with the polarization, reflection, absorption, and refraction of radio waves; ionospheric disturbances; man-made, atmospheric, and interstellar noise; and various forms of modulation.

One chapter discusses noise generated in tubes, resistances, networks, and resonant circuits, and presents mathematical definitions of noise and the noise-figure of electronic tubes.

The section on antennas for the higher frequencies is up-to-date and in-

cludes dipoles, single wire types, loop antennas, parallel-wire arrays, rhombics, V-shaped antennas, parabolas, cones, horns, and wave "lenses". The radiation resistance of antennas is considered at length. The author then delves into wave conductors and resonant devices, properties of transmission lines, and fundamental properties of wave guides and cavity resonators.

Several chapters are devoted to screening and shielding; oscillator design; impedance of mixer, diode, and amplifier tubes; antenna entrance circuits, wide-band amplification, feedback, operation of single- and multi-grid mixers, and frequency drift and control.

The noise of single and multi-grid stages receives considerable attention. Equivalent networks and wide-band detection, microphonics, the selection of tubes, FM receivers, impulse receivers, and radar receivers are among the topics covered.

A lengthy bibliography includes 409 references from 47 publications.—*H.W.S.*

BASIC MATHEMATICS FOR RADIO, by George F. Maedel, E.E. Published by Prentice-Hall, Inc. 5 x 9 1/4 inches, 339 pages. Price \$4.75.

Mathematics is necessary for understanding electronic phenomena but most mathematics books give generalized information including much material not useful to the radio man, and therefore are not particularly interesting to him. This text begins with basic arithmetic and ends with complex numbers. The author, who spent several years teaching mathematics to radio students, has kept his treatment strictly within the lines of usefulness in radio.

Exercise problems and step-by-step explanations of their solutions are spotted plentifully throughout the pages. The reader is carried through the work in logically planned stages so that any intelligent person can use the text for unaided home study. The language is clear and no assumptions are made by the author about previous knowledge on the reader's part.

Mathematics is never a painless subject except to those especially interested in it but this book will at least make numbers and their use easily understandable.—*R.H.D.*

Answers to your problems in THEORY AND DESIGN OF FM EQUIPMENT

Here is a thorough treatment of FM which relates basic principles with best practical methods of design. It covers fundamentals in a detailed chapter which brings out important relations between amplitude, frequency and phase modulation, and lays the basis of treatments available to the design engineer. From such a starting point, this intensive book goes on to practical applications in auxiliary apparatus of FM networks, transmitters, receivers and aerials. It shows use of numerical calculations and design formulas in equipment now in use.



FREQUENCY MODULATION

By August Hund, Consulting Engineer
375 pages, 6x9, 113 illustrations, \$4.50

This book shows you how mathematical formulas are applied to engineering solutions by using tables and curves—gives you explanations directly in the illustrations so that figures can be used without re-reading the text. . . helpful information for employing special design formulas in connection with band width characteristics of networks . . . testing methods useful in designing and maintaining FM receivers.

Here's practical information on formulas for small modulation index, wave propagation in the present-day FM band, time constants in FM networks, FM signal generators, alignment of FM receivers, feeders used in FM systems, transmitter antennas, etc.

10 DAYS FREE EXAMINATION

McGraw-Hill Book Company, Inc.
330 West 42nd Street, N.Y.C. 18

Send me a copy of Hund's Frequency Modulation for 10 days' examination on approval. In 10 days I will remit \$4.50, plus a few cents postage, or return the book postpaid.*

Name

Address

City and State

Position

Company

RC-10-18

* SAVE! We pay postage and packing charges if you send cash with your order. Same return privileges.

RADIOMEN! ELECTRICIANS!

Get this Valuable Book **FREE**

Explains Latest Sets for Merely Examining Coyne's NEW Pay-Raising

5 VOLUME APPLIED PRACTICAL RADIO SET

Here's a PRACTICAL set of radio books just off the press! Gives you "know-how" on everything in Radio today. Basic principles to newest in Television and F.M.—how construct, install, service. Latest trouble-shooting methods. 1000 illustrations, over 1500 pages. Ideal for reference or home training. To prove how valuable these great books can be to you, Coyne will give you a FREE copy of our new, helpful "150 New Radio Diagrams Explained" for looking over the 5 Vol. Set. OFFER LIMITED—ACT NOW! We will send you a vol. set APPLIED PRACTICAL RADIO for 7 days FREE examination, together with Radio Diagrams. Look set over for 7 days. If you like it send \$15 cash, or \$3 after 7 days and \$3 monthly until \$16.75 is paid.

If you don't want the set, return it and you owe NOTHING. Either way you keep Diagrams Book Free. SEND NO MONEY! Coupon asks to see books free and get your gift book for doing it! Send coupon NOW!

FREE BOOK COUPON

Educational Book Publishing Division
COYNE ELECTRICAL & RADIO SCHOOL, Dept. 78-T-1
500 South Paulina St., Chicago 12, Illinois

O.K. Send me postpaid, Coyne's new 5 volume set, "APPLIED PRACTICAL RADIO" for 7 Days FREE TRIAL per your offer. Also send, absolutely FREE, "150 New Radio Diagrams Explained" as a gift.

NAME.....AGE.....

ADDRESS.....

TOWN.....ZONE.....STATE.....

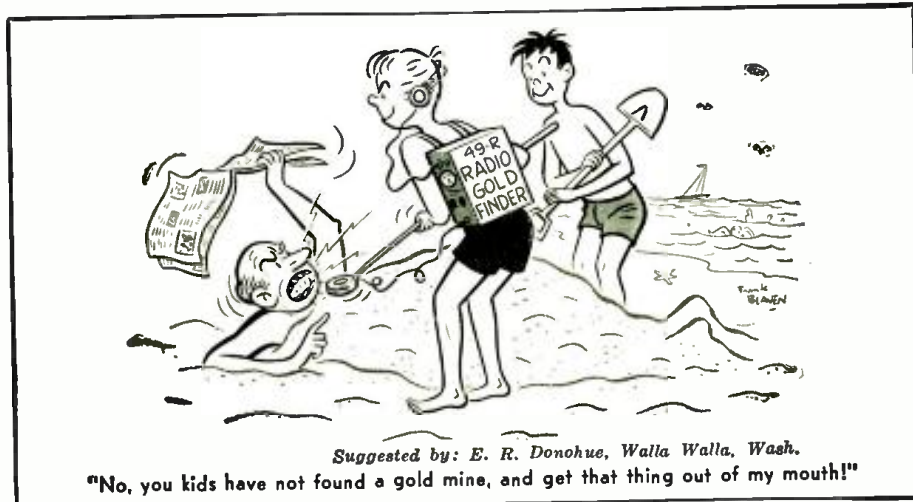

Suggested by: E. R. Donohue, Walla Walla, Wash.

"No, you kids have not found a gold mine, and get that thing out of my mouth!"

RELAYS FOR EVERY PURPOSE Over a Million in Stock!

Whether you require large quantities of relays for production runs or single units for laboratory or amateur work, Wells can make immediate delivery and save you a substantial part of the cost.

Our capable engineering staff is prepared to offer assistance in the selection of correct types to suit your exact requirements.

Each relay is brand new, standard make, inspected, individually boxed and fully guaranteed.

The following list represents only a tiny portion of our relay stock. Write or wire us for information on types not shown.

STANDARD DC TELEPHONE RELAYS

Stock No.	Operating Voltage	Coil Resistance	Contacts	Manufacturer	Net Each
R-101	24V	1500.	DPST (NO)	Auto. Elec.	\$1.35
R-102	24V	400.	SPDT	Auto. Elec.	1.10
R-103	24V	600.	DUAL-1000	Auto. Elec.	1.35
R-105	24V	1300.	3PST (NO)	Clare	1.20
R-106	24V	1300.	3PST (NO)	Clare	1.25
R-152	12V	50	DPDT-SPST (NO)	Guardian	1.10
R-153	12V	200.	SPDT-SPST (NO)	Stromberg	1.25
R-154	12V	200.	SPST (NO)	Clare	1.20
R-155	12V	100.	SPST (NO)	Clare	1.15
R-158	6V	50	4PST (4NO4NC)	Auto. Elec.	1.10
R-159	6V	12	DPST (NO)	Stromberg	1.10
R-160	6V	12	3PDT-3PST (NO)	Auto. Elec.	1.05
R-161	6V	10	3PST (2NC-1NO)	Auto. Elec.	.90
R-121	150V	5000	2PST (NO) SPDT	Clare	1.65
R-123	150V	6300	SPST (NO)	Clare	1.75
R-602	150V	6500	SPST (NO)	Clare	1.75
R-515	24V	750	SPST (NO)	Clare	1.25
R-517	12V	250	DPST (NO)	Clare	1.95
R-519	250V	14000.	SPDT	Auto. Elec.	1.50
R-520	250V	14000	DPDT	R.B.M.	2.10
R-521	32V	1000.	DPDT	Kellogg	1.20
R-166	24V	DUAL-200	DPDT-SPST (NO)	Stromberg	1.59
R-168	24V	DUAL-200	4PST (NO)	Auto. Elec.	1.20
H-240	250-350V	40000	SPDT-SPST (NO)	Auto. Elec.	2.95
H-241	48V	650	SPDT-SPST (NO)	Clare	1.25



SENSITIVE DC RELAYS

Stock No.	Operating Voltage	Coil Resistance	Contacts	Manufacturer	Net Each
R-218	4-6V	1800	SPDT	Murman 220C	\$1.95
R-220	75V	5000	SPDT	Allied Cont.	1.20
R-221	18-24V	5000	SPST (NO)	Allied Cont.	1.15
R-174	250V	5000	DPST (NO)	G.M.	1.85
R-175	350V	11000	OPDT-DPST (NO)	G.M.	2.95
R-176	24V	250	DPST (NO)	G.M.	1.50
R-177	24V	300	4PDT	G.M.	1.65
R-600	8-12V	5000	SPDT	S-Dunn-KS	2.10
R-507	24-48V	1000	SPDT-DPST (NC)	Guardian	1.15

CUTLER HAMMER HEAVY DUTY CONTACTORS



Stock No.	Operating Voltage	Coil Resistance	Contacts	Manufacturer	Net Each
R-178	24V DC	100	SPST (NO) 100A.	6141H34A	\$3.85
R-179	6V DC	6.5	SPST (NO) 50A.	6041H33A	3.00
R-180	12V DC	25	SPST (NO) 50A.	604H308	3.25
R-181	24V DC	65	SPST (NO) 100A.	6041H8B	3.85
H-232	24V	55	SPST (NO) 50A.	Metal Cased	3.25
H-233	6V	15	SPST (NO) 50A.	Metal Cased	3.15
H-235	24V	70.	SPST (NO) 100A.	Type B6	3.85

DIRECT CURRENT AIRCRAFT CONTACTORS

Stock No.	Operating Voltage	Coil Resistance	Contacts	Manufacturer	Net Each
R-182	28V	80	SPST (NO) 25 A.	Guardian	\$1.85
R-183	24V	60	SPST (NO) 50 A.	Allen Bradley	2.75
R-184	28V	50	SPST (NO) 100A.	Type B6A	2.95
R-185	24V	100	SPST (NO) 50 A.	General Elec.	2.75
R-186	24V	132	SPST (NO) 50 A.	Leach 5055ECR	2.75
R-187	24V	100	SPST (NO) 50 A.	Leach 7220-3-24350	2.95
R-188	24V	200	SPST (NO) 50 A.	Allen Bradley	2.95
H-234	14V	45	SPST (NO) 75 A.	Allied Cont.	2.95
			SPST (NO) 30 A.		1.65

ANTENNA CHANGEOVER RELAYS

Stock No.	Operating Voltage	Coil Resistance	Contacts	Manufacturer	Net Each
R-192	6-12V DC	44	2PDT 10 AMP	Allied-NBS	\$1.35
R-231	12VDC	100	DPDT 5 AMP	G. E.	1.95
R-256	24-32V DC	—	SPDT-DPST (NC)		
R-501	110 AC	4	1KW DPDT (1KW)	Guardian	1.45
R-503	12-32V DC	100	SPDT-5PST	G. E.	2.45
				G. E.-500 W	1.95

COMBINATION PUSH BUTTON AND REMOTE RELAY

Stock No.	Operating Voltage	Coil Resistance	Contacts	Manufacturer	Net Each
H-244	12-24V DC	Dual-60	SPDT	CR2791-R106C8	\$1.65

ADJUSTABLE TIME DELAY RELAY

Stock No.	Operating Voltage	Coil Resistance	Contacts	Manufacturer	Net Each
R-246	115 AC	44	SPST (NO) or (NC) 10 AMP	R. W. Cramer	\$8.95
				1-120 Sec	

DC MECHANICAL ACTION RELAYS

Stock No.	Operating Voltage	Coil Resistance	Contacts	Manufacturer	Net Each
R-245	12V	25	4 Lever	G.M.	\$0.95
R-527	6-12V	200.	2 Lever	G.M.	.95

TYPE C.M.S. RELAY

Stock No.	Operating Voltage	Coil Resistance	Contacts	Manufacturer	Net Each
R-511	24V DC	200	MICRO-SW SPST (NO)	Clare	\$2.45

DC CURRENT REGULATOR

Stock No.	Operating Voltage	Coil Resistance	Contacts	Manufacturer	Net Each
R-509	6-12V DC	40	SPST (NC)	G. E.	\$0.85

LATCH AND RESET RELAY

Stock No.	Operating Voltage	Coil Resistance	Contacts	Manufacturer	Net Each
R-500	12V DC	10.	DPDT-10 AMP	St. Dunn-CX-3190B	\$2.85

DC-ROTARY STEP RELAY

Stock No.	Operating Voltage	Coil Resistance	Contacts	Manufacturer	Net Each
R-621	6-12V	30	3 POLE 23 POSITION	W. E.	\$10.95

DC-RATCH RELAY

Stock No.	Operating Voltage	Coil Resistance	Contacts	Manufacturer	Net Each
R-230	5-8V	2	SPDT-DPST (NO)	Guardian	\$2.15

Special Sample Engineering Offer
Any ten relays listed (one of each type) with the exception of Stock Nos. R-621 and R-246—only \$10.00.

ORDER DIRECTLY FROM THIS AD OR THROUGH YOUR LOCAL PARTS JOBBER
Manufacturers: Write For Quantity Prices.
Distributors: Write For The New Wells Jobber Manual.

TYPE 80 DC RELAYS

Stock No.	Operating Voltage	Coil Resistance	Contacts	Manufacturer	Net Each
R-169	24V	250	SPST (NO)	Allied Cont.	\$1.95
R-171	24V	230	DPST (NO)	Allied Cont.	2.15
R-172	5-8V	30	DPDT-SPST (NO)	Allied Cont.	1.70
R-173	2-6V	5	SPST (NO)	Allied Cont.	1.25
R-529	24-48V	1000	DPDT	Allied Cont.	2.50

TYPE BJ DC RELAYS

Stock No.	Operating Voltage	Coil Resistance	Contacts	Manufacturer	Net Each
R-204	24V	250	DPST (NO)	Allied Cont.	\$1.15
R-205	24V	260	DPST (NO)	Allied Cont.	1.25
R-224	12V	75	SPST (NO)	Allied Cont.	1.15
H-237	27V	230	DPDT	Allied Cont.	1.25

HEAVY DUTY KEYING RELAYS

Stock No.	Operating Voltage	Coil Resistance	Contacts	Manufacturer	Net Each
R-248	28V DC	150	SPST (NO) 10A	Guard. 36471	\$1.05
R-244	25V AC	265	SPST (NO) 20A	Leach 1327	1.75
R-206	24V DC	150	PBB-3 AMP.	PBB-HL	1.20
R-207	24V DC	210	4PDT-3 AMP.	PBB-HL	1.10
R-219	50V DC	1500	DPST (NO) 15A	PBB-SP	1.25
R-217	115 AC	600	SPDT-10 AMP	St. Dunn 1XAX2.25	1.25
R-525	24V DC	200	DPDT-10 AMP	Guard 34464	1.25
R-508	110 AC	600	SPDT-6 AMP	Guasd 37189	1.95
R-506	24 V DC	300	DPST (NO) 6A	Guard 516983	1.05
R-510	24 V DC	200	3PDT-10 AMP	St. Dunn-B2A	1.25
R-604	24 V DC	200	SPST (NO) 30A.	St. Dunn-1HXK2.25	1.05
H-608	115 AC	35	3PST (NO) 20A	Guard-BK2	1.35
R-620	12V DC	150	SPST (NO) 40A.	Price Bros.	1.15
R-223	28V DC	80.	DPST (NO) 10A.	R.B.M.	1.20
H-231	12-24V DC	230.	DPST (NO) 5A.	R.B.M.	1.15

DC-TYPE 76 ROTARY RELAYS

Stock No.	Operating Voltage	Coil Resistance	Contacts	Manufacturer	Net Each
R-197	9-16V	70	OPDT	Price Bros.	\$1.65
R-198	9-16V	125	6PST (3NO)	Price Bros.	1.65
R-199	24-32V	250	(3NC) SPDT	Price Bros.	1.65
R-200	24-32V	275	SPDT-DPST (NC)	Price Bros.	1.65
R-201	24-32V	250	3PDT-SPST (NC)	Price Bros.	1.65
R-601	9-14V	60.	OPST (NO) SPOT (NC) OPDT 3PST (NO)	Price Bros.	1.65



DIRECT CURRENT KEYING RELAYS

Stock No.	Operating Voltage	Coil Resistance	Contacts	Manufacturer	Net Each
R-190	12V	65	DPDT 10 AMP	Advance Etec.	\$1.15
R-191	28V	125	DPDT 10 AMP	Guardian	1.20
R-192	12V	44	3PDT 10 AMP	Allied Cont.	1.25
R-193	5-8V	11	DPDT 10 AMP	Type NBS	1.35
R-194	24V	265	SPST (NO)	Leach	1.05
R-195	6V	32	DPST (NO) 10 AMP	Type 1054SNW1.25	1.15
R-196	12V	50	DPST (NO) 10 AMP	G.E.Co.	1.15
R-242	24V	170	SPST (NC)	Guardian	1.15
H-236	5-8V	18.5	SPDT 10 AMP	Leach	1.25
				Leach-HFM	1.05

TYPE 18 DC TELEPHONE RELAYS

Stock No.	Operating Voltage	Coil Resistance	Contacts	Manufacturer	Net Each
R-109	24-48V	4000.	SPDT	Auto. Elec.	\$1.50
R-111	24-32V	3500	SPDT	Auto. Elec.	1.50
R-112	90-120V	6500	SPST (NC)	Auto. Elec.	1.75
R-114	24V	500	DPST (NO)	Auto. Elec.	1.30
R-603	24V	400	DPST (NO)	Auto. Elec.	1.25
H-238	24V	150	OPDT-SPST (NC)	R.B.M.	1.25
H-239	24V	180	DPST (NO)	Auto. Elec.	1.25



SEALED DC TELEPHONE RELAYS

Stock No.	Operating Voltage	Coil Resistance	Contacts	Manufacturer	Net Each
R-125	24V	300.	DPDT	Clare	\$2.75
R-126	90-120V	2000	DPDT	Clare	3.00
R-504	24-70V	2800	SPDT	GE-C103C25	3.00

V TYPE DC TELEPHONE RELAYS

Stock No.	Operating Voltage	Coil Resistance	Contacts	Manufacturer	Net Each
R-164	24-32V	1000	SPST (NO)	W. E.	\$1.20
R-512	24-48V	3500	DPDT	W. E.	1.30
R-513	12-24V	300	DPDT-DPST (NC)	W. E.	1.20
R-514	4-6V	60	SPDT	W. E.	1.05
H-526	6V	35	DPDT-SPST (INC-1NO)	W. E.	1.05

AC-STANDARD TELEPHONE RELAYS

Stock No.	Operating Voltage	Coil Resistance	Contacts	Manufacturer	Net Each
R-212	90-135V	—	NONE	Clare	\$0.95
R-213	5-8V	—	DPST (NO)	Clare	1.50
R-605	24V	—	3PST (NO)	Auto. Elec.	.95
R-606	24V	—	DPST (1NO-1NC)	Auto. Elec.	.95
R-607	24V	—	SPST (NO)	Auto. Elec.	.95



DIRECT CURRENT MIDGET RELAYS

Stock No.	Operating Voltage	Coil Resistance	Contacts	Manufacturer	Net Each
R-132	24V	300	OPDT	Clare	\$1.20
R-133	24V	300	NONE	Clare	.60
R-134	24V	250	4PDT	Clare	1.20
R-135	24V	300	SPST (NC)	Clare	1.15
R-137	24V	300	SPDT	Clare	1.15
R-138	24V	300	4PST (NO)	Clare	1.15
R-139	24V	300	4PST (NO)	Clare	1.15
R-140	24V	280	SPDT	R.B.M.	1.15
R-141	24V	280	3PST (NO)	R.B.M.	1.15
R-142	24V	400	DPDT	Allied Cont.	1.15
R-143	24V	480	SPST (NO)	R.B.M.	1.15
R-144	24V	250	SPST (NO)	Allied Cont.	1.15
R-					

T W X

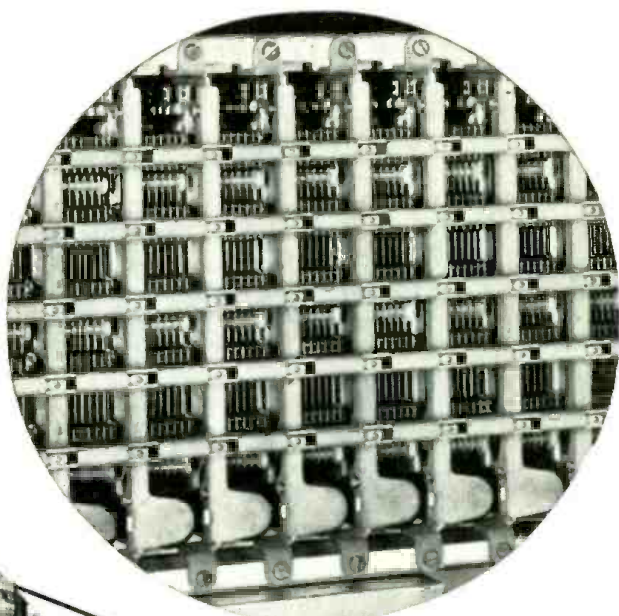

Switches in small offices do a distant operator's bidding.

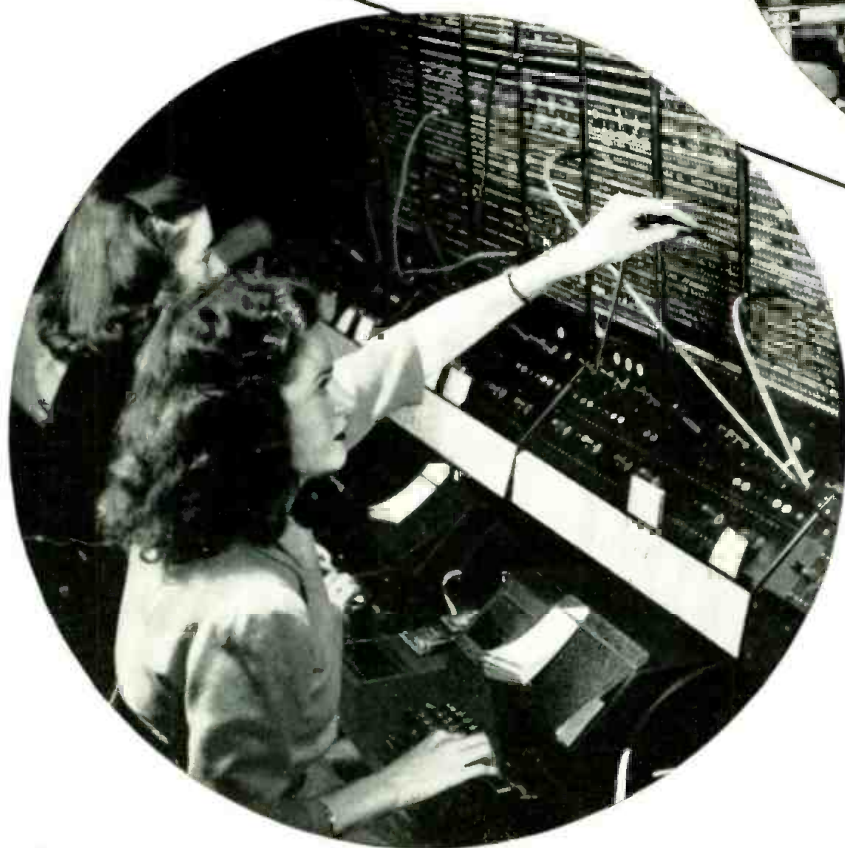

IT TALKS WITH FINGERS

For those who want to talk, Bell Laboratories scientists developed the telephone. For those who prefer the typewritten message, they developed TWX — Teletypewriter Exchange Service.

Fingers on a keyboard send your message to be typed by one or scores of other teletypewriters selected at your request from the 21,000 instruments connected to the Bell System's nationwide TWX network.

As in telephone service, your TWX connection is set up through switching systems, manual or mechanical, as best may serve. And over long distances your message travels economically with many others on the same pair of wires. All these techniques are products of Bell Telephone Laboratories research in the telephone art.

TWX is today a vital link in the nation's chain of communication. And year by year it benefits from the steady growth of the telephone system which carries it.



BELL TELEPHONE LABORATORIES

EXPLORING AND INVENTING, DEVSING AND PERFECTING FOR CONTINUED IMPROVEMENTS AND ECONOMIES IN TELEPHONE SERVICE.

P. R. MALLORY & CO. Inc.

MALLORY Midgetrol

**ALL
NEW**

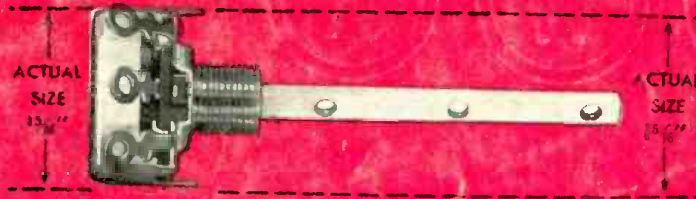

*The Little Volume Control
with BIG Advantages*

**Bigger
Market**

The small size of the Mallory Midgetrol lets you service portables, auto radios and small AC-DC receivers which require $15/16''$ controls.

**Simpler
Installation**

The unique shaft design of the Mallory Midgetrol saves installation time with *all* types of knobs.

**Simpler
Stocking**

Electrical characteristics let you use the Mallory Midgetrol to replace $1\frac{1}{8}''$ as well as $15/16''$ controls. Stocks are further reduced because no special shafts are needed.

The Mallory Midgetrol is quietest by actual tests — and tests prove it stays quiet, too. In addition, it has nine big features that are *all new*.

- NEW SIZE
- NEW DESIGN
- NEW SHAFT
- NEW EXTENSION
- NEW SWITCH
- NEW ELEMENT
- NEW CONTACT
- NEW TERMINAL
- NEW TWO-POINT SUSPENSION

It's the NEW Standard in Carbon Controls. See your Mallory Distributor.

P. R. MALLORY & CO. Inc.

MALLORY

CAPACITORS . . . CONTROLS . . . VIBRATORS
SWITCHES . . . RESISTORS . . . RECTIFIERS . . .
VIBRAPACK® POWER SUPPLIES . . . FILTERS

APPROVED PRECISION PRODUCTS

P. R. MALLORY & CO. Inc. INDIANAPOLIS 6, INDIANA